

Altivar 610

Variable Speed Drives

Programming Manual

07/2014



The information provided in this documentation contains general descriptions and/or technical characteristics of the performance of the products contained herein. This documentation is not intended as a substitute for and is not to be used for determining suitability or reliability of these products for specific user applications. It is the duty of any such user or integrator to perform the appropriate and complete risk analysis, evaluation and testing of the products with respect to the relevant specific application or use thereof. Neither Schneider Electric nor any of its affiliates or subsidiaries shall be responsible or liable for misuse of the information contained herein. If you have any suggestions for improvements or amendments or have found errors in this publication, please notify us.

No part of this document may be reproduced in any form or by any means, electronic or mechanical, including photocopying, without express written permission of Schneider Electric.

All pertinent state, regional, and local safety regulations must be observed when installing and using this product. For reasons of safety and to help ensure compliance with documented system data, only the manufacturer should perform repairs to components.

When devices are used for applications with technical safety requirements, the relevant instructions must be followed.

Failure to use Schneider Electric software or approved software with our hardware products may result in injury, harm, or improper operating results.

Failure to observe this information can result in injury or equipment damage.

© 2014 Schneider Electric. All rights reserved.

Table of Contents



	Safety Information	9
	About the Book	13
Part I	Introduction	15
Chapter 1	Setup	17
	Steps for Setting-Up the Drive	18
	Preliminary Recommendations	19
Chapter 2	Overview	21
	Factory Configuration	22
	Macro Configuration	23
	Basic Functions	25
	Plain Text Display Terminal	26
	Structure of the Parameter Table	28
	Finding a Parameter in This Document	29
Part II	Programming	31
Chapter 3	[Simply start] 5 4 5 -	33
	[Macro-configuration] C F G - Menu	34
	[Simply start] 5 , П - Menu	35
	[Modified parameters] L П d - Menu	39
	[My menu] П 4 П n - Menu	40
Chapter 4	[Display] П o n -	41
4.1	[Motor parameters]	42
	[Motor parameters] П П o - Menu	42
4.2	[Drive parameters]	43
	[Drive parameters] П P , - Menu	43
4.3	[I/O map]	46
	[Digital input map] L , R - Menu	47
	[Phys.ValueAI1] R , 1 C - Menu	48
	[Phys.ValueAI2] R , 2 C - Menu	50
	[Phys.ValueAI3] R , 3 C - Menu	51
	[Phys.ValueAI4] R , 4 C - Menu	52
	[Phys.ValueAI5] R , 5 C - Menu	53
	[AQ1] R o 1 C - Menu	54
	[AQ2] R o 2 C - Menu	58
	[Digital output map] L o R - Menu	59
4.4	[Communication map]	60
	[Communication map] C П П - Menu	61
	[Modbus network diag] П n d - Menu	64
	[Com. scanner input map] , 5 R - Menu	65
	[Com scan output map] o 5 R - Menu	66
	[MODBUS HMI DIAG] П d H - Menu	67
	[Command word image] C W , - Menu	68
	[Freq. ref. word map] r W , - Menu	69
Chapter 5	[Diagnostics] d , R -	71
5.1	[Diag. data]	72
	[Diag. data] d d t - Menu	73
	[Other State] 5 5 t - Menu	78
	[Identification] o , d - Menu	79
5.2	[Error history]	80
	[Error history] P F H - Menu	80

5.3	[Warnings]	83
	[Actual warnings] <i>ALr d</i> - Menu	84
	[Warnings] <i>ALr</i> - Menu	85
Chapter 6	[Complete settings] <i>C 5 t</i> -	87
6.1	[Motor parameters]	88
	[Motor parameters] <i>PPA</i> - Menu	88
6.2	[Input/Output]	97
	[Input/Output] <i>io</i> - Menu	98
	[DI1 Assignment] <i>L 1 C</i> - Menu	100
	[DI2 Assignment] <i>L 2 C</i> - Menu	102
	[DI3 Assignment] <i>L 3 C</i> - Menu	103
	[DI4 Assignment] <i>L 4 C</i> - Menu	104
	[DI5 Assignment] <i>L 5 C</i> - Menu	105
	[DI6 Assignment] <i>L 6 C</i> - Menu	106
	[DI11 Assignment] <i>d 11</i> - Menu	107
	[DI11 Assignment] <i>d 12</i> - Menu	108
	[DI13 Assignment] <i>d 13</i> - Menu	109
	[DI14 Assignment] <i>d 14</i> - Menu	110
	[DI15 Assignment] <i>d 15</i> - Menu	111
	[DI16 Assignment] <i>d 16</i> - Menu	112
	[Configuration DQ11] <i>do 11</i> - Menu	113
	[Configuration DQ12] <i>do 12</i> - Menu	117
	[Input/Output] <i>io</i> - Menu	118
	[AI1 configuration] <i>A 1</i> - Menu	120
	[AI2 configuration] <i>A 2</i> - Menu	123
	[AI3 configuration] <i>A 3</i> - Menu	124
	[AI4 configuration] <i>A 4</i> - Menu	125
	[AI5 configuration] <i>A 5</i> - Menu	127
	[Virtual AI1] <i>Au 1</i> - Menu	128
	[R1 configuration] <i>r 1</i> - Menu	129
	[R2 configuration] <i>r 2</i> - Menu	132
	[R3 configuration] <i>r 3</i> - Menu	133
	[R4 configuration] <i>r 4</i> - Menu	134
	[R5 configuration] <i>r 5</i> - Menu	135
	[R6 configuration] <i>r 6</i> - Menu	136
	[AQ1 configuration] <i>Ao 1</i> - Menu	137
	[AQ2 configuration] <i>Ao 2</i> - Menu	141
6.3	[Command and Reference]	142
	[Command and Reference] <i>Cr P</i> - Menu	142
6.4	[Generic functions] - [Ramp]	150
	[Ramp] <i>r PPP</i> - Menu	150
6.5	[Generic functions] - [Stop configuration]	154
	[Stop configuration] <i>St t t</i> - Menu	154
6.6	[Generic functions] - [Auto DC injection]	158
	[Auto DC injection] <i>A d C</i> - Menu	158
6.7	[Generic functions] - [Preset speeds]	161
	[Preset speeds] <i>P 5 5</i> - Menu	161
6.8	[Generic functions] - [Jump frequency]	165
	[Jump frequency] <i>J u F</i> - Menu	165
6.9	[Generic functions] - [Define system units]	166
	[Define system units] <i>S u C</i> - Menu	166

6.10	[Generic functions] - [PID controller]	170
	[PID controller] P d - Overview	171
	[Feedback] F d b - Menu	174
	[Reference frequency] r F - Menu	180
	[PID preset references] P r i - Menu	182
	[Reference frequency] r F - Menu	184
	[Settings] S t - Menu	185
6.11	[Generic functions] - [Sleep/wakeup]	188
	[Sleep/Wakeup] S P w - Overview	189
	[Sleep menu] S L P - Menu	192
	[Sensor config. AI1] S , F 1 - Menu	194
	[Sensor config. AI2] S , F 2 - Menu	196
	[Sensor config. AI3] S , F 3 - Menu	197
	[Sensor config. AI4] S , F 4 - Menu	198
	[Sensor config. AI5] S , F 5 - Menu	200
	[DI5 sensor configuration] S , F B - Menu	201
	[DI6 sensor configuration] S , F G - Menu	202
	[Sleep menu] S L P - Menu	203
	[Boost] S b t - Menu	204
	[Advanced sleep check] R d S - Menu	205
	[Wake up menu] W k P - Menu	207
6.12	[Generic functions] - [Feedback monitoring]	208
	[Feedback monitoring] F K n - Menu	208
6.13	[Generic functions] - [Threshold reached]	210
	[Threshold reached] t H r E - Menu	210
6.14	[Generic functions] - [Mains contactor command]	212
	[Mains contactor command] L L C - Menu	212
6.15	[Generic functions] - [Parameters switching]	214
	[Parameters switching] n L P - Menu	215
	[Set 1] P S 1 - Menu	218
	[Set 2] P S 2 - Menu	219
	[Set 3] P S 3 - Menu	220
6.16	[Generic functions] - [Stop on prolonged spd]	221
	[Stop after speed timeout] P r S P - Menu	221
6.17	[Generic functions] - [Advanced sleep check]	223
	[Advanced sleep check] R d S - Menu	223
6.18	[Generic monitoring]	225
	[Stall monitoring] S t P r - Menu	226
	[Therm sensor monit] n t S P - Menu	227
6.19	[Error/Warning handling]	234
	[Fault reset] r S t - Menu	235
	[Auto fault reset] R t r - Menu	237
	[Catch on the fly] F L r - Menu	238
	[Motor thermal monit] t H t - Menu	239
	[Output phase loss] o P L - Menu	240
	[Input phase loss] i P L - Menu	241
	[External error] E t F - Menu	242
	[Undervoltage handling] u S b - Menu	243
	[4-20mA loss] L F L - Menu	245
	[Error detection disable] i n H - Menu	246
	[Fieldbus monitoring] C L L - Menu	247
	[Error/Warning handling] C S W n - Menu	248
	[Process underload] u L d - Menu	249
	[Process overload] o L d - Menu	251
	[Warn grp 1 definition] R I C - Menu	253

	[Warn grp 2 definition] <i>A 2 C</i> - Menu	255
	[Warn grp 3 definition] <i>A 3 C</i> - Menu	256
	[Warn grp 4 definition] <i>A 4 C</i> - Menu	257
	[Warn grp 5 definition] <i>A 5 C</i> - Menu	258
6.20	[Maintenance]	259
	[Diagnostics] <i>d R u</i> - Menu	260
	[Fan management] <i>F A n A</i> - Menu	261
	[Maintenance] <i>C S n A</i> - Menu	262
Chapter 7	[Communication] <i>C o n</i> -	263
	[Modbus Fieldbus] <i>n d l</i> - Menu	264
	[Com. scanner input] <i>, C S</i> - Menu	265
	[Com. scanner output] <i>o C S</i> - Menu	266
	[Profibus] <i>P b C</i> - Menu	267
Chapter 8	[File management] <i>F n E</i> -	269
	[Transfer config file] <i>E C F</i> - Menu	270
	[Factory settings] <i>F C S</i> - Menu	271
	[Parameter group list] <i>F r Y</i> - Menu	272
	[Factory settings] <i>F C S</i> - Menu	273
Chapter 9	[My preferences] <i>n Y P</i> -	275
9.1	[Language]	276
	[Language] <i>L n G</i> - Menu	276
9.2	[Password]	277
	[Password] <i>C o d</i> - Menu	277
9.3	[Customization]	278
	[My menu config.] <i>n Y C</i> - Menu	279
	[Display screen type] <i>n S C</i> - Menu	280
	[Param. Bar Select] <i>P b S</i> - Menu	281
	[Customer parameters] <i>C Y P</i> - Menu	282
9.4	[Access level]	283
	[Access level] <i>L A C</i> - Menu	283
9.5	[LCD settings]	284
	[LCD settings] <i>C n L</i> - Menu	284
	Part III Maintenance and diagnostics	285
Chapter 10	Maintenance	287
	Maintenance	287
Chapter 11	Diagnostics and Troubleshooting	289
11.1	Warning Codes	290
	Warning Codes	290
11.2	Error Codes	292
	Overview	294
	[Angle error] <i>A 5 F</i>	295
	[Incorrect Configuration] <i>C F F</i>	296
	[Invalid Configuration] <i>C F i</i>	297
	[Conf Transfer Error] <i>C F , 2</i>	298
	[Fieldbus Com Interrupt] <i>C n F</i>	299
	[Precharge Capacitor] <i>C r F</i>	300
	[Channel Switch Error] <i>C S F</i>	301
	[EEPROM Control] <i>E E F i</i>	302
	[EEPROM Power] <i>E E F 2</i>	303
	[External Error] <i>E P F i</i>	304
	[Fieldbus Error] <i>E P F 2</i>	305
	[Boards Compatibility] <i>H C F</i>	306
	[Internal Link Error] <i>, L F</i>	307
	[Internal Error 0] <i>, n F 0</i>	308
	[Internal Error 1] <i>, n F i</i>	309

[Internal Error 2] <i>i n F 2</i>	310
[Internal Error 3] <i>i n F 3</i>	311
[Internal Error 4] <i>i n F 4</i>	312
[Internal Error 6] <i>i n F 6</i>	313
[Internal Error 7] <i>i n F 7</i>	314
[Internal Error 8] <i>i n F 8</i>	315
[Internal Error 9] <i>i n F 9</i>	316
[Internal Error 10] <i>i n F A</i>	317
[Internal Error 11] <i>i n F b</i>	318
[Internal Error 12] <i>i n F C</i>	319
[Internal Error 13] <i>i n F d</i>	320
[Internal Error 14] <i>i n F E</i>	321
[Internal Error 15] <i>i n F F</i>	322
[Internal Error 16] <i>i n F G</i>	323
[Internal Error 17] <i>i n F h</i>	324
[Internal Error 18] <i>i n F i</i>	325
[Internal Error 20] <i>i n F K</i>	326
[Internal Error 21] <i>i n F L</i>	327
[Internal Error 22] <i>i n F M</i>	328
[Internal Error 25] <i>i n F P</i>	329
[Internal Error 27] <i>i n F r</i>	330
[Input Contactor] <i>L C F</i>	331
[AI1 4-20mA loss] <i>L F F 1</i>	332
[AI2 4-20mA loss] <i>L F F 2</i>	333
[AI3 4-20mA loss] <i>L F F 3</i>	334
[AI4 4-20mA loss] <i>L F F 4</i>	335
[AI5 4-20mA loss] <i>L F F 5</i>	336
[DC Bus Overvoltage] <i>o b F</i>	337
[Overcurrent] <i>o C F</i>	338
[Drive Overheating] <i>o H F</i>	339
[Process Overload] <i>o L C</i>	340
[Motor Overload] <i>o L F</i>	341
[Single Output Phase Loss] <i>o P F 1</i>	342
[Output Phase Loss] <i>o P F 2</i>	343
[Supply Mains Overvoltage] <i>o S F</i>	344
[PID Feedback Error] <i>P F M F</i>	345
[Program Loading Error] <i>P G L F</i>	346
[Program Running Error] <i>P G r F</i>	347
[Input phase loss] <i>P H F</i>	348
[Motor short circuit] <i>S C F 1</i>	349
[Ground Short Circuit] <i>S C F 3</i>	350
[IGBT Short Circuit] <i>S C F 4</i>	351
[Motor Short Circuit] <i>S C F 5</i>	352
[Modbus Com Interruption] <i>S L F 1</i>	353
[PC Com Interruption] <i>S L F 2</i>	354
[HMI Com Interruption] <i>S L F 3</i>	355
[Motor Overspeed] <i>S o F</i>	356
[Motor Stall Error] <i>S t F</i>	357
[AI2 Thermal Sensor Error] <i>t 2 C F</i>	358
[AI3 Thermal Sensor Error] <i>t 3 C F</i>	359
[AI4 Thermal Sensor Error] <i>t 4 C F</i>	360
[AI5 Thermal Sensor Error] <i>t 5 C F</i>	361
[AI2 Th Error Level] <i>t H 2 F</i>	362
[AI3 Th Error Level] <i>t H 3 F</i>	363
[AI4 Th Error Level] <i>t H 4 F</i>	364

	[AI5 Th Error Level] <i>E H S F</i>	365
	[IGBT Overheating] <i>E J F</i>	366
	[Autotuning Error] <i>E n F</i>	367
	[Process Underload] <i>u L F</i>	368
	[Supply Mains Undervoltage] <i>u S F</i>	369
11.3	FAQ	370
	FAQ	370

Safety Information



Important Information

NOTICE



Read these instructions carefully, and look at the equipment to become familiar with the device before trying to install, operate, or maintain it. The following special messages may appear throughout this documentation or on the equipment to warn of potential hazards or to call attention to information that clarifies or simplifies a procedure.



The addition of this symbol to a "Danger" or "Warning" safety label indicates that an electrical hazard exists which will result in personal injury if the instructions are not followed.



This is the safety alert symbol. It is used to alert you to potential personal injury hazards. Obey all safety messages that follow this symbol to avoid possible injury or death.

 DANGER
DANGER indicates a hazardous situation which, if not avoided, will result in death or serious injury .
 WARNING
WARNING indicates a hazardous situation which, if not avoided, could result in death or serious injury .
 CAUTION
CAUTION indicates a hazardous situation which, if not avoided, could result in minor or moderate injury .
NOTICE
NOTICE is used to address practices not related to physical injury.

PLEASE NOTE

Electrical equipment should be installed, operated, serviced, and maintained only by qualified personnel. No responsibility is assumed by Schneider Electric for any consequences arising out of the use of this material.

A qualified person is one who has skills and knowledge related to the construction and operation of electrical equipment and its installation, and has received safety training to recognize and avoid the hazards involved.

Qualification Of Personnel

Only appropriately trained persons who are familiar with and understand the contents of this manual and all other pertinent product documentation are authorized to work on and with this product. In addition, these persons must have received safety training to recognize and avoid hazards involved. These persons must have sufficient technical training, knowledge and experience and be able to foresee and detect potential hazards that may be caused by using the product, by changing the settings and by the mechanical, electrical and electronic equipment of the entire system in which the product is used. All persons working on and with the product must be fully familiar with all applicable standards, directives, and accident prevention regulations when performing such work.

Intended Use

This product is a drive for three-phase synchronous and asynchronous motors and intended for industrial use according to this manual. The product may only be used in compliance with all applicable safety regulations and directives, the specified requirements and the technical data. Prior to using the product, you must perform a risk assessment in view of the planned application. Based on the results, the appropriate safety measures must be implemented. Since the product is used as a component in an entire system, you must ensure the safety of persons by means of the design of this entire system (for example, machine design). Any use other than the use explicitly permitted is prohibited and can result in hazards. Electrical equipment should be installed, operated, serviced, and maintained only by qualified personnel.

Product Related Information

Read and understand these instructions before performing any procedure with this drive.

DANGER

HAZARD OF ELECTRIC SHOCK, EXPLOSION OR ARC FLASH

- Only appropriately trained persons who are familiar with and understand the contents of this manual and all other pertinent product documentation and who have received safety training to recognize and avoid hazards involved are authorized to work on and with this drive system. Installation, adjustment, repair and maintenance must be performed by qualified personnel.
- The system integrator is responsible for compliance with all local and national electrical code requirements as well as all other applicable regulations with respect to grounding of all equipment.
- Many components of the product, including the printed circuit boards, operate with mains voltage. Do not touch. Use only electrically insulated tools.
- Do not touch unshielded components or terminals with voltage present.
- Motors can generate voltage when the shaft is rotated. Prior to performing any type of work on the drive system, block the motor shaft to prevent rotation.
- AC voltage can couple voltage to unused conductors in the motor cable. Insulate both ends of unused conductors of the motor cable.
- Do not short across the DC bus terminals or the DC bus capacitors or the braking resistor terminals.
- Before performing work on the drive system:
 - Disconnect all power, including external control power that may be present.
 - Place a **Do Not Turn On** label on all power switches.
 - Lock all power switches in the open position.
 - Wait 15 minutes to allow the DC bus capacitors to discharge. The DC bus LED is not an indicator of the absence of DC bus voltage that can exceed 800 Vdc. Measure the voltage on the DC bus between the DC bus terminals (PA/+, PC/-) using a properly rated voltmeter to verify that the voltage is <42 Vdc
 - If the DC bus capacitors do not discharge properly, contact your local Schneider Electric representative. Do not repair or operate the product.
- Install and close all covers before applying voltage.

Failure to follow these instructions will result in death or serious injury.

WARNING

UNEXPECTED MOVEMENT

Drive systems may perform unexpected movements because of incorrect wiring, incorrect settings, incorrect data or other errors.

- Carefully install the wiring in accordance with the EMC requirements.
- Do not operate the product with unknown or unsuitable settings or data.
- Perform a comprehensive commissioning test.

Failure to follow these instructions can result in death, serious injury, or equipment damage.

Damaged products or accessories may cause electric shock or unanticipated equipment operation.

DANGER

ELECTRIC SHOCK OR UNANTICIPATED EQUIPMENT OPERATION

Do not use damaged products or accessories.

Failure to follow these instructions will result in death or serious injury.

Contact your local Schneider Electric sales office if you detect any damage whatsoever.

WARNING

LOSS OF CONTROL

- The designer of any control scheme must consider the potential failure modes of control paths and, for critical control functions, provide a means to achieve a safe state during and after a path failure. Examples of critical control functions are emergency stop, overtravel stop, power outage and restart.
- Separate or redundant control paths must be provided for critical control functions.
- System control paths may include communication links. Consideration must be given to the implications of unanticipated transmission delays or failures of the link.
- Observe all accident prevention regulations and local safety guidelines (1).
- Each implementation of the product must be individually and thoroughly tested for proper operation before being placed into service.

Failure to follow these instructions can result in death, serious injury, or equipment damage.

(1) For USA: Additional information, refer to NEMA ICS 1.1 (latest edition), Safety Guidelines for the Application, Installation, and Maintenance of Solid State Control and to NEMA ICS 7.1 (latest edition), Safety Standards for Construction and Guide for Selection, Installation and Operation of Adjustable-Speed Drive Systems.

NOTICE

DESTRUCTION DUE TO INCORRECT MAINS VOLTAGE

Before switching on and configuring the product, verify that it is approved for the mains voltage

Failure to follow these instructions can result in equipment damage.

About the Book



At a Glance

Document Scope

The purpose of this document is to:

- help you to set up the drive,
- show you how to program the drive,
- show you the different menus, modes, and parameters,
- help you in maintenance and diagnostics.

Validity Note

NOTE: The products listed in the document are not all available at the time of publication of this document online. The data, illustrations and product specifications listed in the guide will be completed and updated as the product availabilities evolve. Updates to the guide will be available for download once products are released on the market.

This documentation is valid for the Altivar 610 drives.

The technical characteristics of the devices described in this document also appear online. To access this information online:

Step	Action
1	Go to the Schneider Electric home page www.schneider-electric.com .
2	In the Search box type the reference of a product or the name of a product range. <ul style="list-style-type: none">● Do not include blank spaces in the model number/product range.● To get information on grouping similar modules, use asterisks (*).
3	If you entered a reference, go to the Product Datasheets search results and click on the reference that interests you. If you entered the name of a product range, go to the Product Ranges search results and click on the product range that interests you.
4	If more than one reference appears in the Products search results, click on the reference that interests you.
5	Depending on the size of your screen, you may need to scroll down to see the data sheet.
6	To save or print a data sheet as a .pdf file, click Download XXX product datasheet .

The characteristics that are presented in this manual should be the same as those characteristics that appear online. In line with our policy of constant improvement, we may revise content over time to improve clarity and accuracy. If you see a difference between the manual and online information, use the online information as your reference.

Related Documents

Use your tablet or your PC to quickly access detailed and comprehensive information on all our products on www.schneider-electric.com.

The internet site provides the information you need for products and solutions:

- The whole catalog for detailed characteristics and selection guides,
- The CAD files to help design your installation, available in over 20 different file formats,
- All software and firmware to maintain your installation up to date,
- A large quantity of White Papers, Environment documents, Application solutions, Specifications... to gain a better understanding of our electrical systems and equipment or automation,
- And finally all the User Guides related to your drive, listed below:

(Other option manuals and Instruction sheets are available on www.schneider-electric.com)

Title of Documentation	Reference Number
ATV610 Getting Started	EAV64374 (ENG) EAV64379 (CHI)
ATV610 Installation Manual	EAV64381 (ENG) EAV64386 (CHI)
ATV610 Communication Parameters File	EAV64387 (ENG)
ATV610 Modbus Manual	EAV64395 (ENG)
ATV610 PROFIBUS DP manual	EAV64396 (ENG)

You can download these technical publications and other technical information from our website at www.schneider-electric.com.

Standards and Terminology

The technical terms, terminology, and the corresponding descriptions in this manual normally use the terms or definitions in the relevant standards.

In the area of drive systems this includes, but is not limited to, terms such as **error, error message, failure, fault, fault reset, protection, safe state, safety function, warning, warning message**, and so on.

Among others, these standards include:

- IEC 61800 series: Adjustable speed electrical power drive systems
- IEC 61508 Ed.2 series: Functional safety of electrical/electronic/programmable electronic safety-related
- EN 954-1 Safety of machinery - Safety related parts of control systems
- EN ISO 13849-1 & 2 Safety of machinery - Safety related parts of control systems.
- IEC 61158 series: Industrial communication networks - Fieldbus specifications
- IEC 61784 series: Industrial communication networks - Profiles
- IEC 60204-1: Safety of machinery - Electrical equipment of machines – Part 1: General requirements

Part I

Introduction

What Is in This Part?

This part contains the following chapters:

Chapter	Chapter Name	Page
1	Setup	17
2	Overview	21

Chapter 1

Setup

What Is in This Chapter?

This chapter contains the following topics:

Topic	Page
Steps for Setting-Up the Drive	18
Preliminary Recommendations	19

Steps for Setting-Up the Drive



- 1** **INSTALLATION**
Refer to the installation manual.
- 2** **Apply power to the drive without active run command.**
- 3** **Configure:**
In the **[Simply start] 595** - menu, select the **[Macro Config] CFC** configuration compatible with the wiring used.
- 4** **In the [Simply start] 517 - sub menu, adjust the following parameters:**

 - [Nominal Motor Power] nPr**
 - [Motor Th Current] iLH** only if the factory configuration of the drive is not suitable
 - [Acceleration] RLC** and **[Deceleration] dEL**
 - [Low speed] LSP** and **[High Speed] HSP**
 - [Output Ph Rotation] PHr**
- 5** **Start the drive.**

Tips

Use the **[Config. Source] FLC5** parameter (see page 271) to restore the factory settings at any time.

NOTE: The following operations must be performed for optimum drive performance in terms of accuracy and response time:

- Enter the values indicated on the motor nameplate in the **[Motor parameters] PPR** - menu.
- Perform autotuning with the motor cold and connected using the **[Autotuning] EUN** parameter.

Preliminary Recommendations

Before Powering up the Drive

WARNING

UNANTICIPATED EQUIPMENT OPERATION

Verify that all digital inputs are inactive to avoid any unanticipated operation.

Failure to follow these instructions can result in death, serious injury, or equipment damage.

WARNING

UNEXPECTED MOVEMENT

Drive systems may perform unexpected movements because of incorrect wiring, incorrect settings, incorrect data or other errors.

- Carefully install the wiring in accordance with the EMC requirements.
- Do not operate the product with unknown or unsuitable settings or data.
- Perform a comprehensive commissioning test.

Failure to follow these instructions can result in death, serious injury, or equipment damage.

CAUTION

RISK OF DERATED PERFORMANCE DUE TO CAPACITOR AGING

The product capacitor performances after a long time storage above 2 years can be degraded. In that case, before using the product, apply the following procedure:

- Use a variable AC supply connected between L1 and L2 (even for ATV•••••N4 catalog numbers)
- Increase AC supply voltage to have:
 - 80% of rated voltage during 30 min
 - 100% of rated voltage for another 30 min

Failure to follow these instructions can result in injury or equipment damage.

Start-up

NOTE:

If a Run command such as Run forward, Run reverse, DC injection is still active during:

- a product reset to the factory settings,
- a manual "Fault Reset" using **[Fault Reset Assign]** r 5 F,
- a manual "Fault reset" by applying a product switched off and on again,
- a stop command given by a channel that is not the active channel command (such as Stop key of the display terminal in 2/3 wires control),

NOTE: the drive is in a blocking state and displays **[Freewheel Stop]** r 5 E . it will be necessary to deactivate all active Run commands prior to authorizing a new Run command.

Mains Contactor

NOTICE

RISK OF DAMAGE TO DRIVE

Mains contactor must not be activated with a cycle shorter than 60 s.

Failure to follow these instructions can result in equipment damage.

Using a Motor with a Lower Rating or Dispensing with a Motor Altogether

In factory settings, the motor output phase loss detection is active: **[OutPhaseLoss Assign] $\alpha P L$** is set to **[OPF Error Triggered] $\mathcal{Y} E 5$** . For details, refer to the parameter description ([see page 240](#)). For commissioning tests or maintenance phase, the drive could be connected to a small motor power size and thus trigger an error **[Output Phase Loss] $\alpha P L 2$** or **[Single output phase loss] $\alpha P F 1$** when a Run command is applied. For that purpose, the function can be disabled by setting **[OutPhaseLossAssign] $\alpha P L$** to **[Function Inactive] $n \alpha$** .

Set also **[Motor control type] $L E L$** to **[U/F VC Standard] $S E d$** in **[Motor parameters] $\Pi P R -$** . For details, refer to the parameter description ([see page 90](#)).

NOTICE

MOTOR OVERHEATING

External thermal monitoring against overloads is required under the following circumstances:

- If a motor with a nominal current of less than 20% of the nominal current of the drive is connected.
- If using Motor Switching function

Failure to follow these instructions can result in equipment damage.

DANGER

HAZARD OF ELECTRIC SHOCK, EXPLOSION OR ARC FLASH

If output phase monitoring is disabled, phase loss and, by implication, accidental disconnection of cables, are not detected.

- Verify that the setting of this parameter does not result in unsafe conditions.

Failure to follow these instructions will result in death or serious injury.

Chapter 2

Overview

What Is in This Chapter?

This chapter contains the following topics:

Topic	Page
Factory Configuration	22
Macro Configuration	23
Basic Functions	25
Plain Text Display Terminal	26
Structure of the Parameter Table	28
Finding a Parameter in This Document	29

Factory Configuration

Factory Settings

The drive is factory-set for common operating conditions:

- Display: drive ready **[Ref Frequency]** *L F r* when motor is ready to run and motor frequency when motor is running.
- The DI2 to DI6 digital inputs, AI2 and AI3 analog inputs, R2 and R3 relays are unassigned.
- Stop mode when error detected: freewheel.
- Reverse direction is disabled.

This table presents the basic parameters of the drive and their factory setting values:

Code	Name	Factory Setting Values
<i>b F r</i>	[Basic Frequency]	[50Hz IEC] <i>S D</i>
<i>r i n</i>	[Reverse Disable]	[Yes] <i>Y E S</i>
<i>t c c</i>	[2/3-Wire Control]	[2-Wire Control] <i>2 C</i> : 2-wire control
<i>l t t</i>	[Motor control type]	[U/F VC Quad.] <i>u F 9</i> : U/F for quadratics loads
<i>a c c</i>	[Acceleration]	30.0 s
<i>d e c</i>	[Deceleration]	30.0 s
<i>L S P</i>	[Low Speed]	0.0 Hz
<i>H S P</i>	[High Speed]	50.0 Hz
<i>i t H</i>	[Motor Th Current]	Nominal motor current (value depending on drive rating)
<i>F r d</i>	[Forward]	[DI1] <i>d i 1</i> : Digital input DI1
<i>F r 1</i>	[Ref Freq 1 Config]	[AI1] <i>A i 1</i> : Analog input AI1
<i>r 1</i>	[R1 Assignment]	[Operating State Fault] <i>F L E</i> : the contact opens when the drive has detected error or when the drive has been switched off
<i>b r A</i>	[Dec.Ramp Adapt]	[Yes] <i>Y E S</i> : function active (automatic adaptation of deceleration ramp)
<i>A t r</i>	[Auto Fault Reset]	[No] <i>n o</i> : function inactive
<i>S t t</i>	[Type of stop]	[On Ramp] <i>r n P</i> : on ramp

NOTE: If you want to restore the drive presets to their factory values, set **[Restore config.]** *F C 5* to **[Macro Config]** *i n i*.

Verify whether the above values are compatible with the application and modify them if required.

Macro Configuration

Introduction

The drive offers quick programming using macro configurations that correspond to different applications or uses:

- Start/Stop
- Automatic/Manual control
- PID controller usage
- Preset speeds
- Connection to Modbus fieldbus.

Each of these configurations is still configurable.

Macro Configuration Presets

	[Start/Stop] <i>b 5 t 5</i> (Factory setting)	[Auto/Manual] <i>b A n n</i>	[PID Controller] <i>b P , d</i>	[Preset speeds] <i>b P 5 P</i>	[Modbus] <i>b n b c</i>
[R1 Assignment] <i>r 1</i>	[Operating State Fault] <i>F L t</i>	[Operating State Fault] <i>F L t</i>	[Operating State Fault] <i>F L t</i>	[Operating State Fault] <i>F L t</i>	[Operating State Fault] <i>F L t</i>
[R2 Assignment] <i>r 2</i>	[Drive Running] <i>r u n</i>	[Drive Running] <i>r u n</i>	[Drive Running] <i>r u n</i>	[Drive Running] <i>r u n</i>	[Drive Running] <i>r u n</i>
[R3 Assignment] <i>r 3</i>	[Ready] <i>r d y</i>	[Ready] <i>r d y</i>	[Ready] <i>r d y</i>	[Ready] <i>r d y</i>	[Ready] <i>r d y</i>
[AQ1 assignment] <i>A o 1</i>	[Motor Frequency] <i>a F r</i>	[Motor Frequency] <i>a F r</i>	[Motor Frequency] <i>a F r</i>	[Motor Frequency] <i>a F r</i>	[Motor Frequency] <i>a F r</i>
[AQ1 Type] <i>A o 1 t</i>	[Current] <i>D A</i>	[Current] <i>D A</i>	[Current] <i>D A</i>	[Current] <i>D A</i>	[Current] <i>D A</i>
[AQ1 min output] <i>A o L 1</i>	4 mA	4 mA	4 mA	4 mA	4 mA
[AQ1 max output] <i>A o H 1</i>	20 mA	20 mA	20 mA	20 mA	20 mA
[AQ2 assignment] <i>A o 2</i>	[Motor Current] <i>a C r</i>	[Motor Current] <i>a C r</i>	[Motor Current] <i>a C r</i>	[Motor Current] <i>a C r</i>	[Motor Current] <i>a C r</i>
[AQ2 Type] <i>A o 2 t</i>	[Current] <i>D A</i>	[Current] <i>D A</i>	[Current] <i>D A</i>	[Current] <i>D A</i>	[Current] <i>D A</i>
[AQ2 min output] <i>A o L 2</i>	4 mA	4 mA	4 mA	4 mA	4 mA
[AQ2 max output] <i>A o H 2</i>	20 mA	20 mA	20 mA	20 mA	20 mA
[AI1 Type] <i>A , 1 t</i>	[Voltage] <i>I D u</i>	[Voltage] <i>I D u</i>	[Voltage] <i>I D u</i>	[Voltage] <i>I D u</i>	[Voltage] <i>I D u</i>
[AI1 min value] <i>u , L 1</i>	0 V	0 V	0 V	0 V	0 V
[AI1 max value] <i>u , H 1</i>	10 V	10 V	10 V	10 V	10 V
[AI2 Type] <i>A , 2 t</i>	[Current] <i>D A</i>	[Current] <i>D A</i>	[Current] <i>D A</i>	[Current] <i>D A</i>	[Current] <i>D A</i>
[AI2 min. value] <i>C r L 2</i>	4 mA	4 mA	4 mA	4 mA	4 mA
[AI2 max. value] <i>C r H 2</i>	20 mA	20 mA	20 mA	20 mA	20 mA
[Control Mode] <i>C H C F</i>	[Not separ.] <i>S , n</i>	[Not separ.] <i>S , n</i>	[Not separ.] <i>S , n</i>	[Not separ.] <i>S , n</i>	[Separate] <i>S E P</i>
[Command Switching] <i>C C 5</i>	[Cmd Channel 1] <i>C d 1</i>	[Cmd Channel 1] <i>C d 1</i>	[Cmd Channel 1] <i>C d 1</i>	[Cmd Channel 1] <i>C d 1</i>	[Cmd Channel 1] <i>C d 1</i>
[Cmd channel 1] <i>C d 1</i>	[Terminals] <i>t E r</i>	[Terminals] <i>t E r</i>	[Terminals] <i>t E r</i>	[Terminals] <i>t E r</i>	[Terminals] <i>t E r</i>

	[Start/Stop] b 5 t 5 (Factory setting)	[Auto/Manual] b A n n	[PID Controller] b P , d	[Preset speeds] b P 5 P	[Modbus] b n b C
[Cmd channel 2] C d 2	[Modbus] n d b	[Modbus] n d b	[Modbus] n d b	[Modbus] n d b	[Modbus] n d b
[Freq Switch Assign] r F C	[Ref Freq Channel 1] F r 1	[DI4 Configuration] d , 4	[Ref Freq Channel 1] F r 1	[Ref Freq Channel 1] F r 1	[DI3 Configuration] d , 3
[Ref Freq 1 Config] F r 1	[AI1] A , 1	[AI1] A , 1	[AI1] A , 1	[AI1] A , 1	[Modbus] n d b
[Ref Freq 2 Config] F r 2	[Not Configured] n o	[AI2] A , 2	[Not Configured] n o	[Not Configured] n o	[AI1] A , 1
[2/3-Wire Control] t C C	[2-Wire Control] 2 C	[2-Wire Control] 2 C	[2-Wire Control] 2 C	[2-Wire Control] 2 C	[2-Wire Control] 2 C
[Reverse Assign] r r 5	[Not Assigned] n o	[DI2 Configuration] d , 2	[Not Assigned] n o	[Not Assigned] n o	[Not Assigned] n o
[Fault Reset Assign] r 5 F	[DI2 Configuration] d , 2	[No] n o	[No] n o	[DI2 Configuration] d , 2	[DI2 Configuration] d , 2
[PID feedback] P , F	[No] n o	[No] n o	[AI2] A , 2	[No] n o	[No] n o
[2 Preset Freq] P 5 2	[Not Assigned] n o	[Not Assigned] n o	[Not Assigned] n o	[DI3 Configuration] d , 3	[Not Assigned] n o
[4 Preset Freq] P 5 4	[Not Assigned] n o	[Not Assigned] n o	[Not Assigned] n o	[DI4 Configuration] d , 4	[Not Assigned] n o
[Preset speed 2] S P 2	10	10	10	10	10
[Preset speed 3] S P 3	20	20	20	20	20
[Preset speed 4] S P 4	30	30	30	30	30

Basic Functions

Drive Ventilation

The fan starts automatically when the drive is running and if the **[Fan mode]** *F F Π* is set to **[Standard]** *S t d*.

Plain Text Display Terminal

Description of the Plain Text Display Terminal

This Plain Text Display Terminal is a local control unit which can be either plugged on the drive or mounted on the door of the wall-mounted or floor-standing enclosure. It has a cable with connectors, which is connected to the drive front Modbus serial link.



- 1 **STOP / RESET:** Stop command / apply a Fault Reset.
- 2 **ESC:** used to quit a menu/parameter or remove the currently displayed value in order to revert to the previous value retained in the memory
- 3 **Graphic display.**
- 4 **Home:** access directly the home page.
- 5 **RUN:** executes the function assuming it has been configured.
- 6 **Touch wheel / OK:** used to save the current value or access the selected menu/parameter. The touch wheel is used to scroll fast into the menus. Up/down arrows are used for precise selections, right/left arrows are used to select digits when setting a numerical value of a parameter.

NOTE: Keys 1, 5 and 6 can be used to control the drive, if control via the Plain Text Display Terminal is activated. To activate the keys on the Plain Text Display Terminal, you first need to set **[Config Ref Freq 1] F r 1** to **[Ref.Frequency via Rmt.Term] L L L**.

Description of the Graphic Display

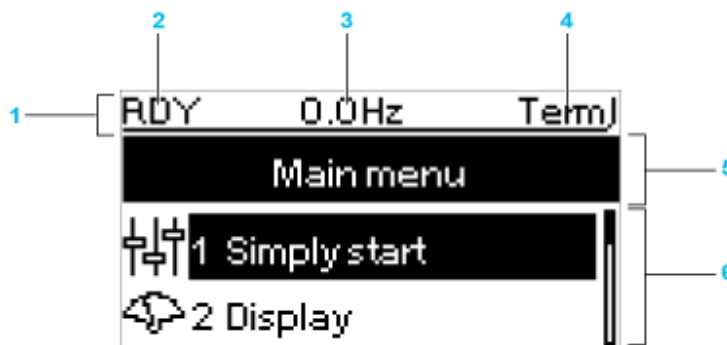

Key	
1	Display line: its content can be configured
2	Drive state
3	Active control channel <ul style="list-style-type: none"> ● TERM: terminals ● HMI: Plain Text Display Terminal ● MDB: integrated Modbus serial ● NET: fieldbus module
4	Customer defined

Key	
5	Menu line: indicates the name of the current menu or submenu
6	Menus, submenus, parameters, values, bar charts, and so on, are displayed in drop-down window format on a maximum of 2 lines. The line or value selected by the navigation button is displayed in reverse video

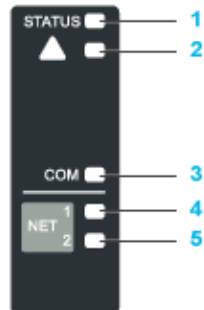

Description of the Product Front LEDs



Key	LED color	LED status	Drive status
1	Green	Blinking	Ready
		Flickering	Acceleration or deceleration
		On	Running
2	Red	Blinking	Warning
		On	Operating state fault
3	Yellow	Blinking	Modbus communication active
4	Green	On	Fieldbus module: communication active
5	Red	On	Fieldbus module: communication detected error
		Blinking	Fieldbus module: incorrect settings

Structure of the Parameter Table

General Legend

Pictogram	Description
	These parameters only appear if the corresponding function has been selected in another menu. When the parameters can also be accessed and adjusted from within the configuration menu for the corresponding function, their description is detailed in these menus, on the pages indicated, to aid programming.
	Setting of this parameter can be done during operation or when stopped. NOTE: It is recommended to stop the motor before modifying any of the settings.
	To change the assignment of the parameter, reinforced validation is required.

Parameter Presentation

Below is an example of a parameter presentation:

[Sample Menu] C o d E – Menu

Access

Parameters described below can be accessed by:

[Path] → [Sub-path]

About this menu

Description of the menu or function

[Parameter1] C o d E 1

Description of the parameter

Example of a table with a setting range:

Setting ()	Description
0.0... 10,000.0	Setting range Factory setting: 50.0

[Parameter2] C o d E 2

Description of the parameter

Example of a table with a list of choices:

Setting ()	Code / Value	Description
[50 Hz IEC]	5 0	IEC Factory setting
[60 Hz NEMA]	6 0	NEMA

Finding a Parameter in This Document

With the Manual

It is possible to use either the parameter name or the parameter code to search in the manual the page giving details of the selected parameter.

Difference Between Menu and Parameter

A dash after menu and submenu codes is used to differentiate menu commands from parameter codes.

Example:

Level	Name	Code
Menu	[Ramp]	<i>r R P -</i>
Parameter	[Acceleration]	<i>R C C</i>

Part II

Programming

What Is in This Part?

This part contains the following chapters:

Chapter	Chapter Name	Page
3	[Simply start] <i>5 Y 5 -</i>	33
4	[Display] <i>П о н -</i>	41
5	[Diagnostics] <i>д , П -</i>	71
6	[Complete settings] <i>Л 5 Ё -</i>	87
7	[Communication] <i>Л о П -</i>	263
8	[File management] <i>Ф П Ё -</i>	269
9	[My preferences] <i>П Y P -</i>	275

Chapter 3

[Simply start] 5 4 5 -

Introduction



[Simply start] 5 4 5 - menu contains 3 tabs for quick access to mains features:

- Simply Start tab which gives a quick access to basic parameters to set.
- My Menu tab which is a user-defined menu for quick access to specific parameters.
- Modified Parameters tab which gives a quick access to the last modified parameters.

What Is in This Chapter?

This chapter contains the following topics:

Topic	Page
[Macro-configuration] C F G - Menu	34
[Simply start] 5 , П - Menu	35
[Modified parameters] L П d - Menu	39
[My menu] П 4 П n - Menu	40

[Macro-configuration] *C F G* - Menu

Access

[Simply start] → [Macro-configuration]

About This Menu

WARNING

UNANTICIPATED EQUIPMENT OPERATION

Verify that the selected macro configuration is compatible with the type of wiring used.

Failure to follow these instructions can result in death, serious injury, or equipment damage.

[Macro Config] *C F G*

Macro configuration.

Setting	Code / Value	Description
[Start/Stop]	<i>b 5 t 5</i>	Start / Stop Factory setting
[Auto/Manual]	<i>b R n n</i>	Auto / Manual
[PID Controller]	<i>b P i d</i>	PID controller
[Preset speeds]	<i>b P 5 P</i>	Preset speeds
[Modbus]	<i>b n b C</i>	Modbus

For more information, refer to the macro configuration presets table ([see page 23](#)).

[Simply start] 5 , Π - Menu

Access

[Simply start] → [Simply start]

About This Menu

This menu provides a quick access to the basic parameters to set.

[Nominal motor power] nPr ★

Nominal motor power.

This parameter can be accessed if:

- [Motor control type] CLE is not set to [SYN_UVC] $SYNU$, and
- [Motor param choice] PPC is set to [Mot Power] nPr .

Rated motor power given on the nameplate, in kW if [Basic Frequency] bFr is set to [50Hz IEC] SD , in HP if [Basic Frequency] bFr is set to [60Hz NEMA] BD .

Setting	Description
According to drive rating	– Factory setting: according to the drive rating

[Motor Th Current] iLH

Motor thermal monitoring current to be set to the rated current indicated on the nameplate.

Setting ()	Description
0.2...1.1 $I_n^{(1)}$	Setting range Factory setting: According to drive rating
(1) Corresponding to the rated drive current indicated in the installation manual and on the drive nameplate.	

[Acceleration] ACC

Time to accelerate from 0 to the [Rated Motor Freq] $F_r 5$. To have a repeatability in the ramps, the value of this parameter must be set according to the possibility of the application.

Setting ()	Description
0.0...6,000.0 s ⁽¹⁾	Setting range Factory setting: 30.0 s
(1) Range 0.01 to 99.99 s or 0.1 to 999.9 s or 1...6,000 s according to [Ramp increment] inc .	

[Deceleration] DEC

Time to decelerate from the [Rated Motor Freq] $F_r 5$ to 0. To have a repeatability in the ramps, the value of this parameter must be set according to the possibility of the application.

Setting ()	Description
0.0...6,000.0 s ⁽¹⁾	Setting range Factory setting: 30.0 s
(1) Range 0.01 to 99.99 s or 0.1 to 999.9 s or 1...6,000 s according to [Ramp increment] inc .	

[Low Speed] LSP

Low speed.

Motor frequency at minimum reference, can be set between 0 and [High Speed] HSP .

Setting ()	Description
0.0... [High Speed] HSP Hz	Setting range Factory setting: 0.0 Hz

[High Speed] H 5 P

High speed.

Motor frequency at maximum reference, can be set between **[Low Speed] L 5 P** and **[Max Frequency] E F r**. The factory setting changes to 60 Hz if **[Basic Frequency] b F r** is set to **[60Hz NEMA] B D**.

Setting ()	Description
0.0... [Max Frequency] E F r Hz	Setting range Factory setting: 50.0 Hz

[Output Ph Rotation] P H r

The modification of this parameter has the same consequence as an inversion of two phases of the motor wiring. It allows you to follow color standards for wiring or to adapt the rotation of the motor to the intended forward direction without any electrical wiring modification.

Setting	Code / Value	Description
[ABC]	<i>A b C</i>	Standard rotation Factory Setting
[ACB]	<i>A C b</i>	Opposite rotation

[Config Ref Freq 1] F r 1

Configuration reference frequency 1.

Setting	Code / Value	Description
[Not Configured]	<i>n o</i>	Not assigned
[AI1]	<i>A , 1</i>	Analog input AI1 Factory Setting
[AI2]...[AI3]	<i>A , 2...A , 3</i>	Analog input AI2...AI3
[AI4]...[AI5]	<i>A , 4...A , 5</i>	Analog input AI4...AI5 if VW3A3203 I/O extension module has been inserted
[Ref Frequency via DI]	<i>u P d t</i>	Up/Down function is assigned by DIx
[Ref Frequency via Rmt. Term]	<i>L C C</i>	Display terminal source
[Ref Frequency via Modbus]	<i>M d b</i>	Modbus source
[Ref Frequency via Com. Module]	<i>n E t</i>	Fieldbus module source
[PulseInput Assignment On DI5]...[PulseInput Assignment On DI6]	<i>P , 5...P , 6</i>	Digital input DI5...DI6 used as pulse input

[OutPhaseLoss Assign] $\alpha P L$ 

Output phase loss assignment.

  DANGER**HAZARD OF ELECTRIC SHOCK, EXPLOSION OR ARC FLASH**

If output phase monitoring is disabled, phase loss and, by implication, accidental disconnection of cables, are not detected.

- Verify that the setting of this parameter does not result in unsafe conditions.

Failure to follow these instructions will result in death or serious injury.

NOTE: [OutPhaseLoss Assign] $\alpha P L$ is set to [Function Inactive] $n \alpha$ when [Motor control type] $C E E$ is set to [SYN_U VC] $S Y n u$.

Setting	Code / Value	Description
[Function Inactive]	$n \alpha$	Function inactive
[OPF Error Triggered]	$Y E 5$	Tripping on [OutPhaseLoss Assign] $\alpha P L$ with freewheel stop Factory setting
[No Error Triggered]	$\alpha R C$	No detected error triggered, but management of the output voltage in order to avoid an overcurrent when the link with the motor is re-established and catch on the fly performed (even if this function has not been configured). The drive switches to [Output cut] $S \alpha C$ state after [OutPhL Time] $\alpha d t$ time. Catch on fly is possible as soon as the drive is in stand by output cut [Output cut] $S \alpha C$ state.

[2/3-wire control] $\text{E } \text{C } \text{E}$ 

2-wire or 3-wire control.

⚠ WARNING

UNANTICIPATED EQUIPMENT OPERATION

If this parameter is changed, the parameters [Reverse Assign] $r r 5$ and [2-wire type] $\text{E } \text{C } \text{E}$ and the assignments of the digital inputs are reset to the factory setting.

Verify that this change is compatible with the type of wiring used.

Failure to follow these instructions can result in death, serious injury, or equipment damage.

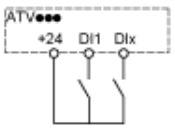
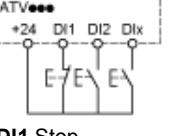
Setting	Code / Value	Description
[2-Wire Control]	$\text{E } \text{C}$	<p>2-wire control (level commands): This is the input state (0 or 1) or edge (0 to 1 or 1 to 0), which controls running or stopping. Example of source wiring:</p>  <p>DI1 Forward DIx Reverse</p> <p>Factory setting</p>
[3-Wire Control]	$\text{E } \text{C}$	<p>3-wire control (pulse commands) [3 wire]: A forward or reverse pulse is sufficient to command starting, a stop pulse is sufficient to command stopping. Example of source wiring:</p>  <p>DI1 Stop DI2 Forward DIx Reverse</p>

[Modified parameters] *L Π d* - Menu

Access

[Simply start] → [Modified parameters]

About This Menu

This menu gives a quick access to the 10 last modified parameters

[My menu] *ΠΥΠΠ* - Menu

Access

[Simply start] → [My menu]

About This Menu

This menu contains the parameters selected in the [My menu config.] *ΠΥΣ* - Menu.

NOTE: This menu is empty by default.

Chapter 4

[Display] Π ο η -

Introduction



[Display] Π ο η - menu shows monitoring data related to the drive and the application.

It offers an application-oriented display in terms of energy, cost, cycle, efficiency, ...

This is available with customized units and graphics view.

What Is in This Chapter?

This chapter contains the following sections:

Section	Topic	Page
4.1	[Motor parameters]	42
4.2	[Drive parameters]	43
4.3	[I/O map]	46
4.4	[Communication map]	60

Section 4.1

[Motor parameters]

[Motor parameters] ▯ ▯ ▯ - Menu

Access

[Display] → [Motor parameters]

About This Menu

This menu shows the motor-related parameters.

[Motor Speed] ▯ ▯ ▯

Motor speed.

Setting	Description
0...65,535 krpm	Setting range Factory setting: _

[Motor Voltage] ▯ ▯ ▯

Motor voltage.

Setting	Description
0...65,535 V	Setting range Factory setting: _

[Motor Power] ▯ ▯ ▯

Motor power.

Output power monitoring (100% = nominal motor power).

Setting	Description
-300.00...300.00%	Setting range Factory setting: _

[Motor Torque] ▯ ▯ ▯

Motor torque.

Output torque value (100% = nominal motor torque).

Setting	Description
-300.00...300.00%	Setting range Factory setting: _

[Motor Current] ▯ ▯ ▯

Motor current.

Setting	Description
0.00...655.35 A	Setting range Factory setting: _

[Motor Therm state] ▯ ▯ ▯

Motor thermal state.

The normal motor thermal state is 100%, the [Motor Overload] ▯ ▯ ▯ is set to 118%.

Setting	Description
0.00...200.00%	Setting range Factory setting: _

Section 4.2

[Drive parameters]

[Drive parameters] ΠP , - Menu

Access

[Display] → [Drive parameters]

About This Menu

This menu shows the drive-related parameters.

[Ref Frequency] $F r H$

Frequency reference before ramp.

This parameter is read-only. It enables you to display the speed reference applied to the motor, regardless of which reference channel has been selected.

Setting	Description
-500.0...500.0 Hz	Setting range Factory setting: _

[Ref Frequency] $L F r$

Reference frequency.

This parameter only appears if the function has been enabled. It is used to change the speed reference from the remote control. OK does not have to be pressed to enable a change of reference.

Setting ()	Description
-500.0...500.0 Hz	Setting range Factory setting: 0.0 Hz

[Motor Frequency] $r F r$

Motor frequency.

Setting	Description
-3,276.8...3,276.7 Hz	Setting range Factory setting: 0.0 Hz

[Mains Voltage] $u L n$

Mains voltage.

Line voltage based on DC bus measurement, motor running or stopped.

Setting	Description
1.0...860.0 V	Setting range Factory setting: _

[DC Bus Voltage] $u b u 5$

DC bus voltage.

Setting	Description
0...65,535	Setting range Factory setting: _

[Drive Therm State] *L H d*

Drive thermal state.

The normal drive thermal state is 100%, the **[Motor Overload]** *a L F* is set to 118%.

Setting	Description
0...200%	Setting range Factory setting: _

[Used Param. Set] *L F P S* ★

Used parameter set.

Configuration parameter status (can be accessed if parameter switching has been enabled).

Setting	Code / Value	Description
[None]	<i>n o</i>	Not assigned
[Set N°1]	<i>L F P 1</i>	Parameter set 1 active
[Set N°2]	<i>L F P 2</i>	Parameter set 2 active
[Set N°3]	<i>L F P 3</i>	Parameter set 3 active

[Motor Run Time] *r L H*

Motor run time.

Run elapsed time display (resettable) in seconds, minutes, or hours (length of time the motor has been switched on).

Setting	Description
0...4,294,967,295 s	Setting range Factory setting: _

[Power-on Time] *P L H*

Power on time.

Setting	Description
0...4,294,967,295 s	Setting range Factory setting: _

[IGBT Warning Counter] *L H C*

IGBT Warning counter.

Setting	Description
0...65,535 s	Setting range Factory setting: _

[PID Reference] *r P C* ★

PID reference.

This parameter can be accessed if **[PID Feedback]** *P i F* is set to **[Not Configured]** *n o*.

Setting	Description
0...65,535%	Setting range Factory setting: -

[PID feedback] r_{PF} ★

PID feedback value.

Setting	Description
0...65,535	Setting range Factory setting: 0

[PID Error] r_{PE} ★

PID error value.

Setting	Description
-32,768...32,767	Setting range Factory setting: _

[PID Output] r_{Po} ★

PID output value.

Output value with limitation.

Setting	Description
-3,276.8...3,276.7 Hz	Setting range Factory setting: _

Section 4.3

[I/O map]

What Is in This Section?

This section contains the following topics:

Topic	Page
[Digital input map] <i>L</i> , <i>R</i> - Menu	47
[Phys.ValueAI1] <i>R</i> , <i>1C</i> - Menu	48
[Phys.ValueAI2] <i>R</i> , <i>2C</i> - Menu	50
[Phys.ValueAI3] <i>R</i> , <i>3C</i> - Menu	51
[Phys.ValueAI4] <i>R</i> , <i>4C</i> - Menu	52
[Phys.ValueAI5] <i>R</i> , <i>5C</i> - Menu	53
[AQ1] <i>R</i> \square <i>1C</i> - Menu	54
[AQ2] <i>R</i> \square <i>2C</i> - Menu	58
[Digital output map] <i>L</i> \square <i>R</i> - Menu	59

[Digital input map] L , R - Menu

Access

[Display] → [I/O map] → [Digital input map]

About This Menu

This menu presents the state and assignment of digital inputs.

Read-only parameters, cannot be configured.

It is used to visualize the state of the digital inputs and Safe Torque Off inputs.

It displays all the functions that are assigned to the digital input in order to verify for multiple assignments.

If no functions have been assigned, **[No]** is displayed. Use the touch wheel to scroll through the functions.

[Phys.ValueAI1] R , I C - Menu

Access

[Display] → [I/O map] → [Analog inputs image] → [Phys.ValueAI1]

About This Menu

This menu presents the characteristics of the analog input.

[Phys.ValueAI1] R , I C

Physical value AI1.

AI1 customer image: value of analog input 1.

Setting	Description
-32,767...32,767	Setting range Factory setting: _

NOTE: The parameters [AI1 Assignment] R , I R, [AI1 min value] L , I, [AI1 max value] H , I and [AI1 filter] R , I F can be accessed on the Plain Text Display Terminal by pressing the OK key on the [Phys.ValueAI1] R , I C parameter.

[AI1 Assignment] R , I R

Analog input AI1 functions assignment. If no function has been assigned, [No] n o is displayed. Read-only parameter, cannot be configured.

It displays all the functions associated with input AI1 in order to verify, for example, for compatibility problems.

Setting	Code / Value	Description
[No]	n o	Not assigned
[AQ1 assignment]	R o 1	Analog output AO1
[AQ2 assignment]	R o 2	Analog output AO2
[Ref.1 channel]	F r 1	Reference source 1
[Ref.2 channel]	F r 2	Reference source 2
[Summing ref. 2]	S R 2	Summing reference 2
[PID Feedback]	P , F	PI feedback (PI control)
[Subtract. Ref. 2]	d R 2	Subtracting reference 2
[Manual PID Reference]	P , n	Manual speed reference of the PID controller (auto-man)
[Speed ref. assign.]	F P ,	Speed reference of the PID controller (predictive reference)
[Summing ref. 3]	S R 3	Summing reference 3
[Ref.1B channel]	F r 1 b	Reference source 1B
[Subtract. ref. 3]	d R 3	Subtracting reference 3
[Forced local]	F L o C	Forced local reference source
[Ref.2 multiplier]	n R 2	Multiplying reference 2
[Ref.3 multiplier]	n R 3	Multiplying reference 3
[Virtual AI1 Channel]	R , I C 1	Virtual AI1 channel selector function
[InletPres Assign]	P 5 I R	Select the source of inlet pressure sensor
[OutletPres Assign]	P 5 2 R	Select the source of inlet pressure sensor
[Inst. Flow Assign.]	F 5 I R	Select the source of installation flow sensor
[Pump Flow Assign.]	F 5 2 R	Select the source of pump flow sensor

[AI1 min value] μ , L I ★

AI1 minimum value.

AI1 voltage scaling parameter of 0%.

This parameter can be accessed if **[AI1 Type] R, IE** is set to **[Voltage] ID μ** .

Setting	Description
0.0...10.0 V	Setting range Factory setting: 0.0 V

[AI1 max value] μ , H I ★

AI1 maximum value.

AI1 voltage scaling parameter of 100%.

This parameter can be accessed if **[AI1 Type] R, IE** is set to **[Voltage] ID μ** .

Setting	Description
0.0...10.0 V	Setting range Factory setting: 10.0 V

[AI1 min. value] C_r L I ★

AI1 minimum value.

AI1 current scaling parameter of 0%.

This parameter can be accessed if **[AI1 Type] R, IE** is set to **[Current] DR**.

Setting	Description
0.0...20.0 mA	Setting range Factory setting: 0.0 mA

[AI1 max. value] C_r H I ★

AI1 maximum value.

AI1 current scaling parameter of 100%.

This parameter can be accessed if **[AI1 Type] R, IE** is set to **[Current] DR**.

Setting	Description
0.0...20.0 mA	Setting range Factory setting: 20.0 mA

[AI1 filter] R, IF

Interference filtering cutoff time of the low-filter.

Setting	Description
0.00...10.00 s	Setting range Factory setting: 0.00 s

[Phys.ValueAI2] *R , 2 C* - Menu

Access

[Display] → [I/O map] → [Analog inputs image] → [Phys.ValueAI2]

About This Menu

This menu presents the characteristics of the analog input.

[Phys.ValueAI2] *R , 2 C*

Physical value AI2.

AI2 customer image: value of analog input 2.

Identical to [Phys.ValueAI1] *R , 1 C* (see page 48).

[AI2 Assignment] *R , 2 R*

Analog input AI2 functions assignment. If no function has been assigned, [No] *n o* is displayed.

Identical to [AI1 Assignment] *R , 1 R* (see page 48).

[AI2 min value] *u , L 2* ★

AI2 voltage scaling parameter of 0%.

This parameter can be accessed if [AI2 type] *R , 2 E* is set to [Voltage] *1 0 u*.

Identical to [AI1 min value] *u , L 1* (see page 49).

[AI2 max value] *u , H 2* ★

AI2 maximum value.

This parameter can be accessed if [AI2 type] *R , 2 E* is set to [Voltage] *1 0 u*.

Identical to [AI1 max value] *u , H 1* (see page 49).

[AI2 min. value] *C r L 2* ★

AI2 current scaling parameter of 0%.

This parameter can be accessed if [AI2 type] *R , 2 E* is set to [Current] *0 R*.

Identical to [AI1 min. value] *C r L 1* (see page 49) with factory setting 4.0 mA.

[AI2 max. value] *C r H 2* ★

AI2 maximum value.

This parameter can be accessed if [AI2 type] *R , 2 E* is set to [Current] *0 R*.

AI2 current scaling parameter of 100%.

Identical to [AI1 max. value] *C r H 1* (see page 49).

[AI2 filter] *R , 2 F*

Interference filtering.

Identical to [AI1 filter] *R , 1 F* (see page 49).

[Phys.ValueAI3] *R* , *3* *C* - Menu

Access

[Display] → [I/O map] → [Analog inputs image] → [Phys.ValueAI3]

About This Menu

This menu presents the characteristics of the analog input.

[Phys.ValueAI3] *R* , *3* *C*

Physical value AI3.

AI3 customer image: value of analog input 3.

Identical to [Phys.ValueAI1] *R* , *1* *C* (see page 48).

[AI3 Assignment] *R* , *3* *R*

Analog input AI3 functions assignment. If no function has been assigned, [No] *n* *a* is displayed.

Identical to [AI1 Assignment] *R* , *1* *R* (see page 48).

[AI3 min value] *u* , *L* *3* ★

AI3 voltage scaling parameter of 0%.

This parameter can be accessed if [AI3 type] *R* , *3* *E* is set to [Voltage] *l* *0* *u*.

Identical to [AI1 min value] *u* , *L* *1* (see page 49).

[AI3 max value] *u* , *H* *3* ★

AI3 voltage scaling parameter of 100%.

This parameter can be accessed if [AI3 type] *R* , *3* *E* is set to [Voltage] *l* *0* *u*.

Identical to [AI1 max value] *u* , *H* *1* (see page 49).

[AI3 min. value] *C* *r* *L* *3* ★

AI3 current scaling parameter of 0%.

This parameter can be accessed if [AI3 type] *R* , *3* *E* is set to [Current] *0* *R*.

Identical to [AI1 min. value] *C* *r* *L* *1* (see page 49).

[AI3 max. value] *C* *r* *H* *3* ★

AI3 current scaling parameter of 100%.

This parameter can be accessed if [AI3 type] *R* , *3* *E* is set to [Current] *0* *R*.

Identical to [AI1 max. value] *C* *r* *H* *1* (see page 49).

[AI3 filter] *R* , *3* *F*

AI3 filter.

Interference filtering.

Identical to [AI1 filter] *R* , *1* *F* (see page 49).

[Phys.ValueAI4] R , 4 C - Menu

Access

[Display] → [I/O map] → [Analog inputs image] → [Phys.ValueAI4]

About This Menu

This menu presents the characteristics of the analog input.
It can be accessed if VW3A3203 I/O extension module has been inserted.

[Phys.ValueAI4] R , 4 C ★

Physical value AI4.
AI4 customer image: value of analog input 4.
Identical to [Phys.ValueAI1] R , 1 C (see page 48).

[AI4 Assignment] R , 4 R ★

Analog input AI4 functions assignment. If no function has been assigned, [No] n o is displayed.
Identical to [AI1 Assignment] R , 1 R (see page 48).

[AI4 min value] v , L 4 ★

AI4 voltage scaling parameter of 0%.
This parameter can be accessed if [AI4 type] R , 4 E is set to [Voltage] 1 0 v .
Identical to [AI1 min value] v , L 1 (see page 49).

[AI4 max value] v , H 4 ★

AI3 voltage scaling parameter of 100%.
This parameter can be accessed if [AI4 type] R , 4 E is set to [Voltage] 1 0 v .
Identical to [AI1 max value] v , H 1 (see page 49).

[AI4 min. value] C r L 4 ★

AI4 current scaling parameter of 0%.
This parameter can be accessed if [AI4 type] R , 4 E is set to [Current] 0 R .
Identical to [AI1 min. value] C r L 1 (see page 49).

[AI4 max. value] C r H 4 ★

AI4 current scaling parameter of 100%.
This parameter can be accessed if [AI4 type] R , 4 E is set to [Current] 0 R .
Identical to [AI1 max. value] C r H 1 (see page 49).

[AI4 filter] R , 4 F ★

Interference filtering cut-off time of the low-filter.
This parameter can be accessed if [AI4 type] R , 4 E is set to [Current] 0 R .
Identical to [AI1 filter] R , 1 F (see page 49).

[Phys.ValueAI5] R , 5 C - Menu

Access

[Display] → [I/O map] → [Analog inputs image] → [Phys.ValueAI5]

About This Menu

This menu presents the characteristics of the analog input. It can be accessed if VW3A3203 I/O extension module has been inserted.

[Phys.ValueAI5] R , 5 C ★

AI5 customer image: value of analog input 5.

Identical to [Phys.ValueAI1] R , 1 C (see page 48).

[AI5 Assignment] R , 5 A ★

AI5 functions assignment. If no functions have been assigned, [No] n o is displayed.

Identical to [AI1 Assignment] R , 1 A (see page 48).

[AI5 min value] V , L 5 ★

AI5 voltage scaling parameter of 0%.

This parameter can be accessed if [AI5 type] R , 5 E is set to [Voltage] I D V.

Identical to [AI1 min value] V , L 1 (see page 49).

[AI5 max value] V , H 5 ★

AI5 voltage scaling parameter of 100%.

This parameter can be accessed if [AI5 type] R , 5 E is set to [Voltage] I D V.

Identical to [AI1 max value] V , H 1 (see page 49).

[AI5 min. value] C r L 5 ★

AI5 current scaling parameter of 0%.

This parameter can be accessed if [AI5 type] R , 5 E is set to [Current] D A.

Identical to [AI1 min. value] C r L 1 (see page 49).

[AI5 max. value] C r H 5 ★

AI5 current scaling parameter of 100%.

This parameter can be accessed if [AI5 type] R , 5 E is set to [Current] D A.

Identical to [AI1 max. value] C r H 1 (see page 49).

[AI5 filter] R , 5 F ★

Interference filtering cut-off time of the low-filter.

Identical to [AI1 filter] R , 1 F (see page 49).

[AQ1] R o IC - Menu

Access

[Display] → [I/O map] → [Analog outputs image] → [AQ1]

About This Menu

Analogic output functions.

Following parameters can be accessed on the Plain Text Display Terminal by pressing the OK key on the [AQ1] R o IC parameter.

Minimum and Maximum Output Values

The minimum output value, in volts, corresponds to the lower limit of the assigned parameter and the maximum value corresponds to its upper limit. The minimum value may be greater than the maximum value.

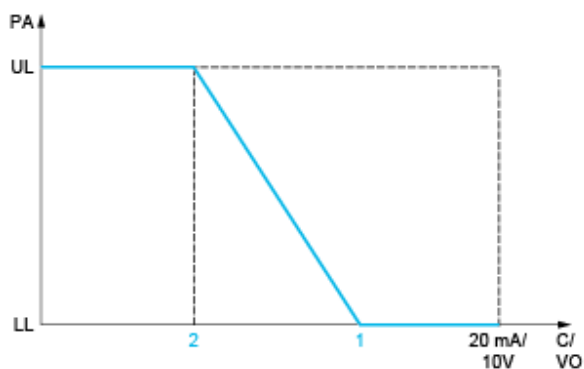
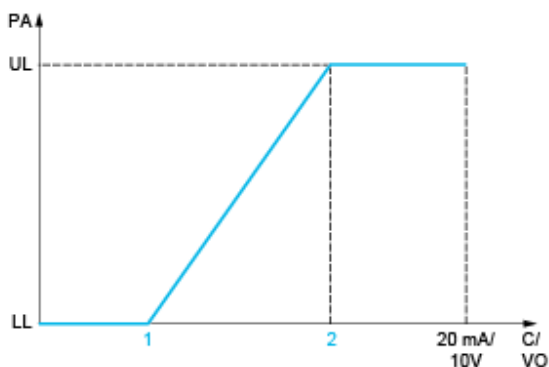

PA Parameter assigned

C / VO Current or voltage output

UL Upper limit

LL Lower limit

1 [Min Output] R o L X or u o L X

2 [Max Output] R o H X or u o H X

Scaling of the Assigned Parameter

The scale of the assigned parameter can be adapted in accordance with requirements by modifying the values of the lower and upper limits with 2 parameters for each analog output.

These parameters are given in %. 100% corresponds to the total variation range of the configured parameter, so: 100% = upper limit - lower limit.

For example, **[Sign. torque] 5 L 9** which varies between -3 and +3 times the rated torque, 100% corresponds to 6 times the rated torque.

- The **[Scaling AQx min] R 5 L X** parameter modifies the lower limit: new value = lower limit + (range x R 5 L X). The value 0% (factory setting) does not modify the lower limit.
- The **[Scaling AQx max] R 5 H X** parameter modifies the upper limit: new value = lower limit + (range x R 5 L X). The value 100% (factory setting) does not modify the upper limit.
- **[Scaling AQx min] R 5 L X** must always be lower than **[Scaling AQx max] R 5 H X**.

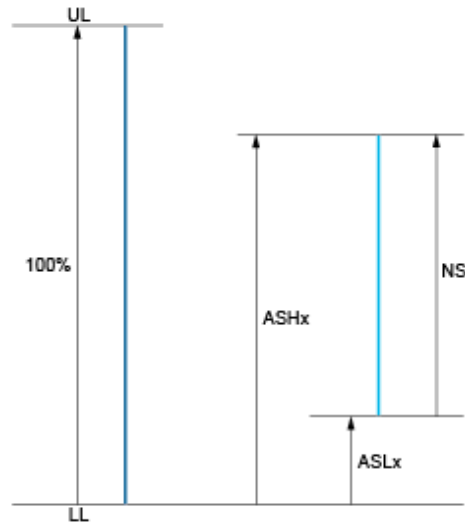

- UL Upper limit of the assigned parameter
- LL Lower limit of the assigned parameter
- NS New scale
- 1 R 5 H X
- 2 R 5 L X

Application Example

The value of the motor current at the AO1 output is to be transferred with 0...20 mA, range 2 In motor, In motor being the equivalent of a 0.8 In drive.

- The **[Motor Current] 0 C r** parameter varies from 0 to 2 times the rated drive current, or a range of 2.5 times the rated drive current.
- **[Scaling AQ1 min] R 5 L 1** must not modify the lower limit, which therefore remains at its factory setting of 0%.
- **[Scaling AQ1 max] R 5 H 1** must modify the upper limit by 0.5x the rated motor torque, or 100 - 100/5 = 80% (new value = lower limit + (range x R 5 H 1)).

[AQ1] R 0 1 C

AO1 customer image: value of analog output 1.

Setting ()	Description
-32,767...32,767	Setting range Factory setting: _

[AQ1 Assignment] R o I

AO1 assignment.

Setting	Code / Value	Description
[Not Configured]	n o	Not assigned Factory Setting
[Motor Current]	o C r	Current in the motor, from 0 to 2 In (In = rated drive current indicated in the Installation manual and on the drive nameplate)
[Motor Frequency]	o F r	Output frequency, from 0 to [Max Frequency] E F r
[Ramp out.]	o r P	From 0 to [Max Frequency] E F r
[Motor torq.]	t r q	Motor torque, from 0 to 3 times the rated motor torque
[Sign. torque]	S t q	Signed motor torque, between -3 and +3 times the rated motor torque. The + sign corresponds to the motor mode and the - sign to the generator mode (braking).
[sign ramp]	o r S	Signed ramp output, between -[Max Frequency] E F r and +[Max Frequency] E F r
[PID ref.]	o P S	PID regulator reference between [Min PID reference] P , P I and [Max PID reference] P , P Z
[PID feedbk]	o P F	PID regulator feedback between [Min PID feedback] P , F I and [Max PID feedback] P , F Z
[PID error]	o P E	PID regulator detected error between -5% and +5% of [Max PID feedback] P , F Z - [Min PID feedback] P , F I
[PID output]	o P i	PID regulator output between [Low speed] L S P and [High speed] H S P
[Drive power]	o P r	Motor power, between 0 and 2.5 times [Nominal Motor Power] n P r
[Mot thermal]	t H r	Motor thermal state, from 0 to 200% of the rated thermal state
[Drv thermal]	t H d	Drive thermal state, from 0 to 200% of the rated thermal state
[Sig. o/p frq.]	o F S	Signed output frequency, between -[Max Frequency] E F r and +[Max Frequency] E F r
[Motor volt.]	u o P	Voltage applied to the motor, between 0 and [Nom Motor Voltage] u n S warning
[Inlet Pressure Value]	P S I u	Water: Inlet pressure sensor
[Outlet Pressure Value]	P S Z u	Water: Outlet pressure sensor
[Installation Flow]	F S I u	Water: Installation flow rate sensor unit

[AQ1 min Output] u o L I ★

AO1 minimum output.

This parameter can be accessed if [AQ1 Type] R o I t is set to [Voltage] I D u.

Setting	Description
0.0...10.0 V	Setting range Factory setting: 0.0 V

[AQ1 max Output] u o H I ★

AO1 maximum output.

This parameter can be accessed if [AQ1 Type] R o I t is set to [Voltage] I D u.

Setting	Description
0.0...10.0 V	Setting range Factory setting: 10.0 V

[AQ1 min output] *R o L I* ★

AO1 minimum output.

This parameter can be accessed if **[AQ1 Type] *R o I E*** is set to **[Current] *D R***.

Setting	Description
0.0...20.0 mA	Setting range Factory setting: 4.0 mA

[AQ1 Max Output] *R o H I* ★

AO1 maximum output.

This parameter can be accessed if **[AQ1 Type] *R o I E*** is set to **[Current] *D R***.

Setting	Description
0.0...20.0 mA	Setting range Factory setting: 20.0 mA

[Scaling AQ1 min] *R S L I*

Scaling of the lower limit of the assigned parameter, as a % of the maximum possible variation.

Setting	Description
0.0...100.0%	Setting range Factory setting: 0.0%

[Scaling AQ1 max] *R S H I*

Scaling of the upper limit of the assigned parameter, as a % of the maximum possible variation.

Setting	Description
0.0...100.0%	Setting range Factory setting: 100.0%

[AQ1 Filter] *R o I F*

Interference filtering.

This parameter is forced to 0 if **[AQ1 Assignment] *R o I*** is set to **[DQ1] *d o I***.

Setting	Description
0.00...10.00 s	Setting range Factory setting: 0.00 s

[AQ2] $R \square \mathcal{Z} \mathcal{L}$ - Menu

Access

[Display] → [I/O map] → [Analog outputs image] → [AQ2]

About This Menu

Analog output functions.

Following parameters are visible on the Plain Text Display Terminal by pressing the $\square K$ key on the [AQ2] $R \square \mathcal{Z} \mathcal{L}$ parameter.

[AQ2] $R \square \mathcal{Z} \mathcal{L}$

AO2 customer image: value of analog output 2.

Identical to [AQ1] $R \square \mathcal{I} \mathcal{L}$ (see page 55).

[AQ2 assignment] $R \square \mathcal{Z}$

AO2 assignment.

Identical to [AQ1 Assignment] $R \square \mathcal{I}$ (see page 56).

[AQ2 min Output] $\cup \square \mathcal{L} \mathcal{Z} \star$

AO2 minimum output.

This parameter can be accessed if [AQ2 Type] $R \square \mathcal{Z} \mathcal{L}$ is set to [Voltage] $\mathcal{I} \mathcal{D} \cup$.

Identical to [AQ1 min Output] $\cup \square \mathcal{L} \mathcal{I}$ (see page 56).

[AQ2 max Output] $\cup \square \mathcal{H} \mathcal{Z} \star$

AO2 maximum output.

This parameter can be accessed if [AQ2 Type] $R \square \mathcal{Z} \mathcal{L}$ is set to [Voltage] $\mathcal{I} \mathcal{D} \cup$.

Identical to [AQ1 max Output] $\cup \square \mathcal{H} \mathcal{I}$ (see page 56).

[AQ2 min output] $R \square \mathcal{L} \mathcal{Z} \star$

AO2 minimum output.

This parameter can be accessed if [AQ2 Type] $R \square \mathcal{Z} \mathcal{L}$ is set to [Current] $\mathcal{D} \mathcal{R}$.

Identical to [AQ1 min Output] $R \square \mathcal{L} \mathcal{I}$ (see page 57).

[AQ2 max output] $R \square \mathcal{H} \mathcal{Z} \star$

AO2 maximum output.

This parameter can be accessed if [AQ2 Type] $R \square \mathcal{Z} \mathcal{L}$ is set to [Current] $\mathcal{D} \mathcal{R}$.

Identical to [AQ1 max Output] $R \square \mathcal{H} \mathcal{I}$ (see page 57).

[Scaling AQ2 min] $R \mathcal{S} \mathcal{L} \mathcal{Z}$

Scaling of the lower limit of the assigned parameter, as a % of the maximum possible variation.

Identical to [Scaling AQ1 Min] $R \mathcal{S} \mathcal{L} \mathcal{I}$ (see page 57).

[Scaling AQ2 max] $R \mathcal{S} \mathcal{H} \mathcal{Z}$

Scaling of the upper limit of the assigned parameter, as a % of the maximum possible variation.

Identical to [Scaling AQ1 max] $R \mathcal{S} \mathcal{H} \mathcal{I}$ (see page 57).

[AQ2 Filter] $R \square \mathcal{Z} \mathcal{F}$

Interference filtering.

This parameter is forced to 0 if [AQ2 assignment] $R \square \mathcal{Z}$ is set to [DQ2] $\mathcal{d} \square \mathcal{Z}$.

Identical to [AQ1 Filter] $R \square \mathcal{I} \mathcal{F}$ (see page 57).

[Digital output map] *L □ R* - Menu

Access

[Display] → [I/O map] → [Digital output map]

About This Menu

This menu presents the state and assignment of digital outputs.

Section 4.4

[Communication map]

What Is in This Section?

This section contains the following topics:

Topic	Page
[Communication map] <i>C P P</i> - Menu	61
[Modbus network diag] <i>P n d</i> - Menu	64
[Com. scanner input map] <i>i S R</i> - Menu	65
[Com scan output map] <i>o S R</i> - Menu	66
[MODBUS HMI DIAG] <i>P d H</i> - Menu	67
[Command word image] <i>C W i</i> - Menu	68
[Freq. ref. word map] <i>r W i</i> - Menu	69

[Communication map] C П П - Menu

Access

[Display] → [Communication map]

[Command Channel] C П д C

Command channel.

Setting	Code / Value	Description
[Terminals]	т Е р П	Terminal block
[HMI]	Н П ,	Plain Text Display Terminal
[Modbus]	П д б	Modbus communication
[Com. Module]	н Е т	Fieldbus option module

[Cmd Register] C П д

Drivecom command register.

[Control Mode] C H C F is not set to [I/O profile] , 0

Possible values in CiA402 profile, separate, or not separate mode:

Bit	Description, Value
0	Set to 1: "Switch on"/Contactor command
1	Set to 0: "Disable voltage"/Authorization to supply AC power
2	Set to 0: "Quick stop"
3	Set to 1: "Enable operation"/Run command
4 to 6	Reserved (= 0)
7	"Fault reset" acknowledgment active on 0 to 1 rising edge
8	Set to 1: Halt stop according to the [Type Of Stop] 5 т т parameter without leaving the operation enabled state
9 and 10	Reserved (= 0)
11 to 15	Can be assigned to commands

Possible values in the I/O profile. On state command [2-Wire Control] 2 C :

Bit	Description, Value
0	Forward (on state) command: 0: No forward command 1: Forward command NOTE: The assignment of bit 0 cannot be modified. It corresponds to the assignment of the terminals. It can be switched. Bit 0 C д д д is only active if the channel of this control word is active.
1 to 15	Can be assigned to commands

Possible values in the I/O profile. On edge command [3-Wire Control] 3 C :

Bit	Description, Value
0	Stop (run authorization): 0: Stop 1: Run is authorized on a forward or reverse command
1	Forward (on 0 to 1 rising edge) command
2 to 15	Can be assigned to commands
NOTE: The assignment of bits 0 and 1 cannot be modified. It corresponds to the assignment of the terminals. It can be switched. Bits 0 C д д д and 1 C д д are only active if the channel of this control word is active.	

[Ref Freq Channel] р F C C

Channel of reference frequency.

Identical to [Command Channel] C П д C (see page 61)

[Pre-Ramp Ref Freq] F r H

Frequency reference before ramp.

Setting	Description
-500.0...500.0 Hz	Setting range Factory setting: _

[CIA402 State Reg] E L R

CIA402 State Register.

Possible values in CiA402 profile, separate, or not separate mode:

Bit	Description, Value
0	"Ready to switch on", awaiting power section line supply
1	"Switched on", ready
2	"Operation enabled", running
3	Operating detected error state: 0: Inactive 1: Active
4	"Voltage enabled", power section line supply present: 0: Power section line supply absent 1: Power section line supply present NOTE: When the drive is powered by the power section only, this bit is always at 1.
5	Quick stop
6	"Switched on disabled", power section line supply locked
7	Warning: 0: No warning 1: Warning
8	Reserved (= 0)
9	Remote: command or reference via the network 0: Command or reference via the Plain Text Display Terminal 1: Command or reference via the network
10	Targets reference reached: 0: The reference is not reached 1: The reference has been reached NOTE: When the drive is in speed mode, this is the speed reference.
11	"Internal limit active", reference outside limits: 0: The reference is within the limits 1: The reference is not within the limits NOTE: When the drive is in speed mode, the limits are defined by the [Low speed] L 5 P and [High speed] H 5 P parameters.
12	Reserved
13	Reserved
14	"Stop key", STOP via stop key: 0: STOP key not pressed 1: Stop triggered by the STOP key on the Plain Text Display Terminal
15	"Direction", direction of rotation: 0: Forward rotation at output 1: Reverse rotation at output
NOTE: The combination of bits 0, 1, 2, 4, 5 and 6 defines the state in the DSP 402 state chart (see the communication manuals).	

Possible values in the I/O profile:

Bit	Description, Value
0	Reserved (= 0 or 1)
1	Ready: 0: Not ready 1: Ready
2	Running: 0: The drive does not start if a reference other than zero is applied 1: Running, if a reference other than zero is applied, the drive can start
3	Operating detected error state: 0: Inactive 1: Active
4	Power section line supply present: 0: Power section line supply absent 1: Power section line supply present
5	Reserved (= 1)
6	Reserved (= 0 or 1)
7	Warning 0: No warning 1: Warning
8	Reserved (= 0)
9	Command via a network: 0: Command via the terminals or the Plain Text Display Terminal 1: Command via a network
10	Reference reached: 0: The reference is not reached 1: The reference has been reached
11	Reference outside limits: 0: The reference is within the limits 1: The reference is not within the limits NOTE: When the drive is in speed mode, the limits are defined by LSP and HSP parameters.
12	Reserved (= 0)
13	Reserved (= 0)
14	Stop via STOP key: 0: STOP key not pressed 1: Stop triggered by the STOP key on the Plain Text Display Terminal
15	Direction of rotation: 0: Forward rotation at output 1: Reverse rotation at output
NOTE: The value is identical in the CiA402 profile and the I/O profile. In the I/O profile, the description of the values is simplified and does not refer to the CiA402 (Drivecom) state chart.	

[Modbus network diag] *Π n d* - Menu

Access

[Display] → [Communication map] → [Modbus network diag]

About This Menu

Used for the Modbus serial communication port at the bottom of the control block. Refer to the Modbus serial embedded communication manual for a complete description.

[COM LED] *Π d b l*

View of the Modbus communication LED.

[Mdb Frame Nb] *Π I C L*

Modbus network frames counter: number of processed frames.

Setting	Description
0...65,535	Setting range Factory setting: _

[Mb NET CRC errors] *Π I E C*

Modbus network CRC error counter: number of CRC errors.

Setting	Description
0...65,535	Setting range Factory setting: _

[Com. scanner input map] , 5 H - Menu

Access

[Display] → [Communication map] → [Modbus network diag] → [Com. scanner input map]

About This Menu

Used for Modbus network.

[Com Scan In1 val.] H H I

Com scanner input 1 value. Value of the first input word.

Setting	Description
0...65,535	Setting range Factory setting: _

[Com Scan In2 val.] H H J

Com scanner input 2 value. Value of the second input word.

Identical to [Com Scan In1 val.] H H I (see page 65).

[Com Scan In3 val.] H H K

Com scanner input 3 value. Value of the third input word.

Identical to [Com Scan In1 val.] H H I (see page 65).

[Com Scan In4 val.] H H L

Com scanner input 4 value. Value of the fourth input word.

Identical to [Com Scan In1 val.] H H I (see page 65).

[Com Scan In5 val.] H H M

Com scanner input 5 value. Value of the fifth input word.

Identical to [Com Scan In1 val.] H H I (see page 65).

[Com Scan In6 val.] H H N

Com scanner input 6 value. Value of the sixth input word.

Identical to [Com Scan In1 val.] H H I (see page 65).

[Com Scan In7 val.] H H O

Com scanner input 7 value. Value of the seventh input word.

Identical to [Com Scan In1 val.] H H I (see page 65).

[Com Scan In8 val.] H H P

Com scanner input 8 value. Value of the eighth input word.

Identical to [Com Scan In1 val.] H H I (see page 65).

[Com scan output map] ▢ 5 A - Menu

Access

[Display] → [Communication map] → [Com scan output map]

About This Menu

Used for Modbus networks.

[Com Scan Out1 val.] n L 1

Com scanner output 1 value. Value of the first output word.

Setting 	Description
0...65,535	Setting range Factory setting: _

[Com Scan Out2 val.] n L 2

Com scanner output 2 value. Value of the second output word.

Identical to [Com Scan Out1 val.] n L 1 (see page 66).

[Com Scan Out3 val.] n L 3

Com scanner output 3 value. Value of the third output word.

Identical to [Com Scan Out1 val.] n L 1 (see page 66).

[Com Scan Out4 val.] n L 4

Com scanner output 4 value. Value of the fourth output word.

Identical to [Com Scan Out1 val.] n L 1 (see page 66).

[Com Scan Out5 val.] n L 5

Com scanner output 5 value. Value of the fifth output word.

Identical to [Com Scan Out1 val.] n L 1 (see page 66).

[Com Scan Out6 val.] n L 6

Com scanner output 6 value. Value of the sixth output word.

Identical to [Com Scan Out1 val.] n L 1 (see page 66).

[Com Scan Out7 val.] n L 7

Com scanner output 7 value. Value of the seventh output word.

Identical to [Com Scan Out1 val.] n L 1 (see page 66).

[Com Scan Out8 val.] n L 8

Com scanner output 8 value. Value of the eighth output word.

Identical to [Com Scan Out1 val.] n L 1 (see page 66).

[MODBUS HMI DIAG] ПДН - Menu**Access**

[Display] → [Communication map] → [MODBUS HMI DIAG]

About This Menu

Used for the Modbus serial communication port at the front of the control block (used by the Plain Text Display Terminal)

[COM LED] ПДБЭ

View of the Modbus HMI communication LED.

[Mdb NET frames] ПЭСЛ

Terminal Modbus 2: number of processed frames.

Setting ()	Description
0...65,535	Setting range

[Mdb NET CRC errors] ПЭЕЛ

Terminal Modbus 2: number of CRC errors.

Setting ()	Description
0...65,535	Setting range

[Command word image] - Menu

Access

[Display] → [Communication map] → [Command word image]

About This Menu

Command word image.

[Modbus Cmd]

Command word image built with Modbus port source.

Identical to [CMD Value]  (*see page 61*).

[COM. Module Cmd.]

Command word image built with fieldbus module source.

Identical to [CMD Value]  (*see page 61*).

[Freq. ref. word map] *r W* - Menu

Access

[Display] → [Communication map] → [Freq. ref. word map]

About This Menu

Frequency reference image.

[Modbus Ref Freq] *L F r I*

Frequency reference image built with Modbus port source (LFR_MDB).

Setting 	Description
-32,768...32,767 Hz	Setting range Factory setting: 0.0 Hz

[Com Module Ref Freq] *L F r E*

Frequency reference image built with fieldbus module source (LFR_COM).

Setting 	Description
-32,768...32,767 Hz	Setting range Factory setting: 0.0 Hz

Chapter 5

[Diagnostics] d , R -

Introduction



[Diagnostics] d , R - menu presents drive and application data useful when diagnostics is required.

What Is in This Chapter?

This chapter contains the following sections:

Section	Topic	Page
5.1	[Diag. data]	72
5.2	[Error history]	80
5.3	[Warnings]	83

Section 5.1

[Diag. data]

What Is in This Section?

This section contains the following topics:

Topic	Page
[Diag. data] <i>d d t</i> - Menu	73
[Other State] <i>5 5 t</i> - Menu	78
[Identification] <i>o i d</i> - Menu	79

[Diag. data] d d t - Menu**Access****[Diagnostics] → [Diag. data]****About This Menu**

This menu presents the actual warning and detected error in addition to drive data.

[Last Warning] L A L r

Last warning which occurred.

Setting	Code / Value	Description
[No Warning Stored]	n o A	No warning stored
[Fallback speed]	F r F	Reaction on event / fallback speed
[Speed Maintained]	r L S	Reaction on event / maintain speed
[Type of Stop]	S t t	Reaction on event / stop on [Type of stop] S t t without tripping in error
[Ref Frequency Warning]	S r A	Frequency reference reached
[Life Cycle Warning 1]	L C A 1	Life cycle warning 1
[Life Cycle Warning 2]	L C A 2	Life cycle warning 2
[PID Error Warning]	P E E	Warning on PID error
[PID Feedback Warning]	P F A	Warning on PID feedback
[PID High Feedback Warning]	P F A H	PID feedback high threshold reached
[PID Low Feedback Warning]	P F A L	PID feedback low threshold reached
[Regulation Warning]	P , S H	PI feedback monitoring warning is raised
[AI2 Th Warning]	t P 2 A	Temperature monitoring AI2 warning
[AI3 Th Warning]	t P 3 A	Temperature monitoring AI3 warning
[AI4 Th Warning]	t P 4 A	Temperature monitoring AI4 warning
[AI5 Th Warning]	t P 5 A	Temperature monitoring AI5 warning
[AI1 4-20 Loss Warning]	A P 1	AI1 4-20 loss warning on AI1
[AI2 4-20 Loss Warning]	A P 2	AI2 4-20 loss warning on AI2
[AI3 4-20 Loss Warning]	A P 3	AI3 4-20 loss warning on AI3
[AI4 4-20 Loss Warning]	A P 4	AI4 4-20 loss warning on AI4
[AI5 4-20 Loss Warning]	A P 5	AI5 4-20 loss warning on AI5
[Drive Thermal Warning]	t H A	Drive overheating warning is raised
[IGBT Thermal Warning]	t J A	Warning on IGBT thermal state
[Fan Counter Warning]	F C t A	Fan counter speed warning
[Fan Feedback Warning]	F F d A	Fan feedback warning is raised

Setting	Code / Value	Description
[Ext. Error Warning]	<i>E F A</i>	External error warning
[Undervoltage Warning]	<i>u S A</i>	Undervoltage warning is raised
[Preventive Undervolt Active]	<i>u P A</i>	Controlled stop on power loss threshold id reached
[Motor Freq High Thd]	<i>F E A</i>	Motor frequency high threshold 1 reached
[Motor Freq Low Thd]	<i>F E A L</i>	Motor frequency low threshold 1 reached
[Motor Freq High Thd 2]	<i>F 9 L A</i>	Motor frequency high threshold 2 reached
[Motor Freq Low Thd 2]	<i>F 2 A L</i>	Motor frequency low threshold 2 reached
[High Speed Reached]	<i>F L A</i>	High speed reached function result
[Ref Freq High Thd Reached]	<i>r E A H</i>	Reference frequency high threshold reached
[Ref Freq High Thd Reached]	<i>r E A L</i>	Reference frequency low threshold reached
[2nd Frequency Thd Reached]	<i>F 2 A</i>	Frequency level reached (frequency meter)
[Current Threshold Reached]	<i>C E A</i>	Motor current high threshold reached
[Low I Thd Reached]	<i>C E A L</i>	Motor current low threshold reached
[Process Underload Warning]	<i>u L A</i>	Underload is detected
[Process Overload Warning]	<i>o L A</i>	Overload is detected
[Torque Limit Reached]	<i>S S A</i>	Timeout on current or torque limitation is reached
[Drive Thermal Thd Reached]	<i>t A d</i>	Drive thermal threshold reached function result
[Motor Therm Thd Reached]	<i>t S A</i>	Motor thermal threshold reached function result (motor 1)
[Power High Threshold]	<i>P E H A</i>	Power high threshold reached
[Power Low Threshold]	<i>P E H L</i>	Power low threshold reached
[Cust Warning 1]	<i>C A S 1</i>	Customer warning 1 active
[Cust Warning 2]	<i>C A S 2</i>	Customer warning 2 active
[Cust Warning 3]	<i>C A S 3</i>	Customer warning 3 active
[Cust Warning 4]	<i>C A S 4</i>	Customer warning 4 active
[Cust Warning 5]	<i>C A S 5</i>	Customer warning 5 active

[Last Error] L F t

Last error which occurred.

Setting	Code / Value	Description
[No Error]	n o F	No error detected
[EEPROM Control]	E E F 1	EEPROM control
[Incorrect Configuration]	C F F	Invalid configuration at power-on
[Invalid Configuration]	C F i	Incorrect parameter configuration
[Modbus Com Interruption]	S L F 1	Modbus local serial communication error
[Internal Link Error]	i L F	Option internal link error
[Fieldbus Com Interrupt]	C n F	NET option communication error
[External Error]	E P F 1	External error from LI or local link
[Overcurrent]	o C F	Over current error
[Precharge]	C r F	Load relay error
[AI2 4-20mA Loss]	L F F 2	AI2 4-20 mA loss error
[Drive Overheating]	o H F	Drive over heating error
[Motor Overload]	o L F	Motor overload error
[DC Bus Overvoltage]	o b F	DC bus overvoltage
[Supply Mains Overvoltage]	o S F	Over supply error
[Single Output Phase Loss]	o P F 1	Motor 1-phase loss
[Input Phase Loss]	P H F	Main input 1-phase loss
[Supply Mains Undervoltage]	u S F	Under voltage error
[Motor Short Circuit]	S C F 1	Motor short circuit error (hard detection)
[Motor Overspeed]	S o F	Over speed error
[Autotuning Error]	t n F	Tune error
[Internal Error 1]	i n F 1	Unknown drive rating
[Internal Error 2]	i n F 2	Unknown or incompatible power board
[Internal Error 3]	i n F 3	Internal serial link communication error
[Internal Error 4]	i n F 4	Invalid industrialization zone
[EEprom Power]	E E F 2	Power EEPROM failure
[Ground Short Circuit]	S C F 3	Direct ground short-circuit error (hard detection)
[Output Phase Loss]	o P F 2	Motor 3-phases loss
[Internal Error 7]	i n F 7	CPLD communication error
[Fieldbus Error]	E P F 2	External error from communication board
[Internal Error 11]	i n F B	Supply mains failure
[PC Com Interruption]	S L F 2	PC software communication interruption
[HMI Com Interruption]	S L F 3	Plain Text Display Terminal communication error

Setting	Code / Value	Description
[Internal Error 9]	<i>i n F 9</i>	Current measurement circuit failure
[Internal Error 10]	<i>i n F A</i>	Customer supply failure
[Internal Error 11]	<i>i n F b</i>	Thermal sensor failure (OC or SC)
[IGBT Overheating]	<i>t J F</i>	IGBT over heating error
[IGBT Short Circuit]	<i>S C F 4</i>	IGBT short-circuit error (hard detection)
[Motor Short Circuit]	<i>S C F 5</i>	Load short-circuit error during long load sequence (hard detection)
[Input Contactor]	<i>L C F</i>	Line contactor failure
[Internal Error 6]	<i>i n F 6</i>	Unknown or incompatible option module
[Internal Error 14]	<i>i n F E</i>	CPU error (ram, flash, task ...)
[AI3 4-20 mA Loss]	<i>L F F 3</i>	AI3 4-20 mA loss
[AI4 4-20 mA Loss]	<i>L F F 4</i>	AI4 4-20 mA loss
[Boards Compatibility]	<i>H C F</i>	Hardware configuration error
[Conf Transfer Error]	<i>C F i 2</i>	Configuration transfer error
[AI5 4-20 mA Loss]	<i>L F F 5</i>	AI5 4-20 mA loss
[Channel Switch Error]	<i>C S F</i>	Channel switching error
[Process Underload]	<i>u L F</i>	Torque underload error
[Process Overload]	<i>o L C</i>	Torque overload error
[Angle Error]	<i>A 5 F</i>	Angle Setting error
[AI1 4-20 mA loss]	<i>L F F 1</i>	AI1 4-20 mA loss
[AI2 Th Detected Error]	<i>t H 2 F</i>	AI2 thermal sensor detected error
[AI2 Thermal Sensor Error]	<i>t 2 C F</i>	Thermal sensor error on AI2
[AI3 Th Detected Error]	<i>t H 3 F</i>	AI3 thermal sensor detected error
[AI3 Thermal Sensor Error]	<i>t 3 C F</i>	Thermal sensor error on AI3
[AI4 Th Detected Error]	<i>t H 4 F</i>	AI4 thermal sensor detected error
[AI4 Thermal Sensor Error]	<i>t 4 C F</i>	Thermal sensor error on AI4
[AI5 Th Detected Error]	<i>t H 5 F</i>	AI5 thermal sensor detected error
[AI5 Thermal Sensor Error]	<i>t 5 C F</i>	Thermal sensor error on AI5
[PID FeedBack Error]	<i>P F n F</i>	PID feedBack detected error
[Program Loading Error]	<i>P G L F</i>	Program loading detected error
[Program Running Error]	<i>P G r F</i>	Program running detected error
[Internal Error 16]	<i>i n F G</i>	Internal error 16
[Internal Error 17]	<i>i n F H</i>	Internal error 17
[Internal Error 0]	<i>i n F 0</i>	Internal error 0 (IPC)
[Internal Error 13]	<i>i n F d</i>	Internal error 13 (different current)

Setting	Code / Value	Description
[Motor Stall Error]	<i>S L F</i>	Motor stall detected error
[Internal Error 21]	<i>i n F L</i>	Internal error 21 (RTC)
[Internal Error 15]	<i>i n F F</i>	Internal error 15 (flash)
[Internal Error 22]	<i>i n F n</i>	Internal error 22 (update)
[Internal Error 25]	<i>i n F P</i>	Internal error 25
[Internal Error 20]	<i>i n F K</i>	Internal error 20
[Internal Error 27]	<i>i n F r</i>	Internal error 27

[Nb of start] *n S n*

Number of motor starts.

Setting	Description
0...4,294,967,295	Setting range Factory setting: 0

[Motor Run Time] *r L H*

Motor run time.

Setting	Description
0...4,294,967,295 s	Setting range Factory setting: _

[Other State] 5 5 6 - Menu

Access

[Diagnostics] → [Diag. data] → [Other State]

About This Menu

List of secondary states.

List

[Sleep Active] 5 L 0
[Sleep Boost active] 5 L P b
[Sleep Checking activated] R 5 L C
[Set 1 active] C F P 1
[Set 2 active] C F P 2
[Set 3 active] C F P 3
[Set 4 active] C F P 4
[PID Active] R u t o
[DC Bus Charged] d b L
[Fast stop Active] F 5 6
[Fallback Frequency] F r F
[Speed Maintained] r L 5
[Type of stop] 5 6 6
[Frequency ref. att.] 5 r R
[Forward] 0 F r d
[Reverse] 0 r r 5
[In motor fluxing] F L X
[Autotuning] 6 u n

[Identification] - Menu

Access

[Diagnostics] → [Diag. data] → [Identification]

About This Menu

This is a read-only menu that cannot be configured. It enables the following information to be displayed:

- Drive reference, power rating, and voltage
- Drive software version
- Drive serial number
- Type of option modules present, with their software version
- Plain Text Display Terminal type and version

Section 5.2

[Error history]

[Error history] P F H - Menu

Access

[Diagnostics] → [Error history]

About This Menu

This menu shows the 8 last detected errors (*d P 1* to *d P 8*).

Pressing OK key on the selected error code in the Error history list displays the drive data recorded when the error has been detected.

NOTE: Same content for [Last Error 1] *d P 1* to [Last Error 8] *d P 8*.

[Last Error 1] *d P 1*

Last error 1.

Identical to [Last Error] *L F 1* (see page 75).

[Drive State] *H 5 1*

HMI status.

Setting	Code / Value	Description
[Autotuning]	<i>t u n</i>	Autotuning
[In DC inject.]	<i>d C b</i>	Injection braking
[Ready]	<i>r d y</i>	Drive ready
[Freewheel]	<i>n 5 t</i>	Freewheel stop control
[Drv running]	<i>r u n</i>	Motor in steady state or run command present and zero reference
[Accelerating]	<i>A C C</i>	Accelerating
[Decelerating]	<i>d E C</i>	Decelerating
[Current lim.]	<i>C L i</i>	Current limit
[Fast stop]	<i>F 5 t</i>	Fast stop
[Motor fluxing]	<i>F L u</i>	Fluxing function is activated
[no mains V.]	<i>n L P</i>	Control is powered on but the DC bus is not loaded
[control.stop]	<i>C t L</i>	Controlled stop
[Dec. adapt.]	<i>a b r</i>	Adapted deceleration
[Output cut]	<i>S o C</i>	Stand by output cut
[UnderV. al.]	<i>u 5 A</i>	Undervoltage warning
[In mfg. test]	<i>t C</i>	TC indus mode activated
[in autotest]	<i>5 t</i>	Self test in progress
[autotest err]	<i>F A</i>	Self test detected error
[Autotest OK]	<i>4 E 5</i>	Self test OK
[EEPROM test]	<i>E P</i>	Self test EEPROM detected error
[Operating State Fault]	<i>F L t</i>	Operating state fault
[DCP Flashing Mode]	<i>d C P</i>	DCP flashing mode
[Idle State]	<i>i d L E</i>	Idle state

[Last Error 1 Status] *E P 1*

Status of last error 1.

DRIVECOM status register (same as [ETA state word] *E t A*).

[ETI state word] , P I

ETI state word.
ETI status register (see the communication parameter file).

[Cmd word] C P I

Cmd word.
Command register (same as **[Cmd word] C P d**).

[Motor current] L C P I

Motor current (same as **[Motor Current] L C r**).

Setting	Description
-3,276.7...3,276.7 A	Setting range Factory setting: _

[Output frequency] r F P I

Output frequency (same as **[Output frequency] r F r**).

Setting	Description
-3,276.7...3,276.7 Hz	Setting range Factory setting: _

[Elapsed Time] r t P I

Elapsed time.

Setting	Description
0...65,535 h	Setting range Factory setting: _

[Mains Voltage] u L P I

Mains voltage (same as **[Mains Voltage] u L n**).

Setting	Description
0...6,553.5 V	Setting range Factory setting: _

[Motor therm state] t H P I

Motor thermal state (same as **[Motor Therm state] t H r**).

Setting	Description
0...65,535%	Setting range Factory setting: _

[Command Channel] d C C I

Command channel (same as **[Command channel] C P d C**).

Setting	Code / Value	Description
[Terminals]	t E r n	Terminal block
[Local]	L o C	Local control
[HMI]	H n i	Plain Text Display Terminal
[Modbus]	n d b	Modbus communication
[+/- speed]	t u d	Increase/decrease speed
[LUD->NotDef]	L u d	LUD->NotDef
[Com. Module]	n E t	Ext. communication module
[Mfg]	i n d	Indus
[PC tool]	P w S	PC tool

[Ref Freq Channel] d r C I

Channel for reference frequency (same as **[Ref Freq Channel] r F C C**).

Setting	Code / Value	Description
[Terminals]	t E r	Terminal block
[Local]	L o C	Local control
[HMI]	H P i	Plain Text Display Terminal
[Modbus]	M d b	Modbus communication
[+/- speed]	t u d	Increase/decrease speed
[Com. Module]	n E t	Ext. communication module
[PC tool]	P W 5	PC tool

[Motor Torque] o t P I

Estimated motor torque value (same as **[Motor Torque] o t r**).

Setting	Description
-3,276.7...3,276.7%	Setting range Factory setting: _

[Drive Thermal State] t d P I

Measured drive thermal state (same as **[Drive Therm State] t H d**).

Setting	Description
0...355%	Setting range Factory setting: _

[IGBT Junction Temp] t J P I

Estimated junction temperature value.

Setting	Description
0...255°C	Setting range Factory setting: _

[Switching Frequency] 5 F P I

Switching frequency applied (related to **[Switching Frequency] 5 F r**).

Setting	Description
0...65,535 Hz	Setting range Factory setting: _

[Last Error 2] d P 2 to [Last Error 8] d P 8

Last error 2... Last error 8

Identical to **[Last Error 1] d P 1** (see page 80).

Section 5.3

[Warnings]

What Is in This Section?

This section contains the following topics:

Topic	Page
[Actual warnings] <i>FL r d</i> - Menu	84
[Warnings] <i>FL r</i> - Menu	85

[Actual warnings] *FLr d* - Menu

Access

[Diagnostics] → [Warnings] → [Actual warnings]

About This Menu

List of current warnings.

If a warning is present, ✓ and  appears on the Plain Text Display Terminal.

List of Available Warnings

Identical to [Last warning] *FLr L* (*see page 73*).

[Warnings] *FLr* - Menu

Access

[Diagnostics] → [Warnings]

About This Menu

This menu presents the warning history (30 past warnings).

[Warning History] *FLH*

Identical to [Last warning] *FLrL* (*see page 73*).

Chapter 6

[Complete settings] [5 E -

Introduction



[Complete settings] [5 E - menu presents all the settings related to drive functions for:

- Motor and drive configuration
- Application functions
- Monitoring functions

What Is in This Chapter?

This chapter contains the following sections:

Section	Topic	Page
6.1	[Motor parameters]	88
6.2	[Input/Output]	97
6.3	[Command and Reference]	142
6.4	[Generic functions] - [Ramp]	150
6.5	[Generic functions] - [Stop configuration]	154
6.6	[Generic functions] - [Auto DC injection]	158
6.7	[Generic functions] - [Preset speeds]	161
6.8	[Generic functions] - [Jump frequency]	165
6.9	[Generic functions] - [Define system units]	166
6.10	[Generic functions] - [PID controller]	170
6.11	[Generic functions] - [Sleep/wakeup]	188
6.12	[Generic functions] - [Feedback monitoring]	208
6.13	[Generic functions] - [Threshold reached]	210
6.14	[Generic functions] - [Mains contactor command]	212
6.15	[Generic functions] - [Parameters switching]	214
6.16	[Generic functions] - [Stop on prolonged spd]	221
6.17	[Generic functions] - [Advanced sleep check]	223
6.18	[Generic monitoring]	225
6.19	[Error/Warning handling]	234
6.20	[Maintenance]	259

Section 6.1

[Motor parameters]

[Motor parameters] ПРА - Menu

Access

[Complete settings] → [Motor parameters]

[Basic Frequency] б F r ★

Basic frequency.

This parameter modifies the presets of the following parameters:

- [High Speed] H S P
- [Motor Freq Thd] F t d
- [Nom Motor Voltage] u n S
- [Nominal Motor Freq] F r S
- [Max Frequency] t F r

This parameter cannot be accessed if [Motor Control Type] C t t is set to [SYN_U VC] S Y n u.

Setting	Code / Value	Description
[50 Hz IEC]	5 0	IEC Factory setting
[60 Hz NEMA]	6 0	NEMA

[Nominal motor Power] n P r ★

Nominal motor power.

This parameter cannot be accessed if [Motor Control Type] C t t is set to [SYN_U VC] S Y n u.

Rated motor power given on the nameplate, in kW if [Basic Frequency] б F r is set to [50Hz IEC] 5 0, in HP if [Basic Frequency] б F r is set to [60Hz NEMA] 6 0.

Setting	Description
According to drive rating	– Factory setting: according to the drive rating

[Nom Motor Voltage] u n S ★

Nominal motor voltage.

This parameter cannot be accessed if [Motor Control Type] C t t is set to [SYN_U VC] S Y n u.

Rated motor voltage given on the nameplate.

Setting	Description
100...690 V	Setting range Factory setting: according to drive rating and [Basic Frequency] б F r

[Nom Motor Current] n C r ★

Rated motor current given on the nameplate.

This parameter cannot be accessed if [Motor Control Type] C t t is set to [SYN_U VC] S Y n u.

Setting	Description
0.25...1.5 In ⁽¹⁾	Setting range Factory setting: according to drive rating and [Basic Frequency] б F r
(1) Corresponding to the rated drive current indicated in the installation manual and on the drive nameplate.	

[Nominal Motor Freq] $F_r 5$ ★

Nominal motor frequency.

This parameter cannot be accessed if **[Motor Control Type] $C_t E$** is set to **[SYN_U VC] 5 Y n u**.

The factory setting is 50 Hz, or preset to 60 Hz if **[Basic Frequency] $b F_r$** is set to 60 Hz.

Setting	Description
40.0...500.0 Hz	Setting range Factory setting: 50 Hz

[Nominal Motor Speed] $n 5 P$ ★

Nominal motor speed.

This parameter cannot be accessed if **[Motor Control Type] $C_t E$** is set to **[SYN_U VC] 5 Y n u**.

If the nameplate indicates the synchronous speed and the slip in Hz or as a %, use any 1 of the formulas to calculate the rated speed:

- Nominal speed = Synchronous speed x $\frac{100 - \text{slip as a \%}}{100}$
- Nominal speed = Synchronous speed x $\frac{60 - \text{slip in Hz}}{60}$ (60 Hz motors)
- Nominal speed = Synchronous speed x $\frac{50 - \text{slip in Hz}}{50}$ (50 Hz motors).

Setting	Description
0...65,535 rpm	Setting range Factory setting: according to drive rating

[Max Frequency] $E F_r$

Maximum output frequency.

The factory setting is 60 Hz, or preset to 72 Hz if **[Basic Frequency] $b F_r$** is set to 60 Hz.

Setting	Description
10.0...500.0 Hz	Setting range Factory setting: 60 Hz

[Motor Th Current] $I_{t H}$

Motor thermal monitoring current to be set to the rated current indicated on the nameplate.

Setting (1)	Description
0.2...1.1 I_n (1)	Setting range Factory setting: According to drive rating
(1) Corresponding to the rated drive current indicated in the installation manual and on the drive nameplate.	

[Output Ph Rotation] $P H_r$

Output phase rotation.

Modifying this parameter will operate as an inversion of 2 of the 3 motor phases. This results in changing the direction of rotation of the motor.

Setting	Code / Value	Description
[ABC]	$A B C$	Standard rotation Factory setting
[ACB]	$A C B$	Opposite rotation

[Motor Control Type] *U F U*

Motor control type.

NOTE: Select the motor control type before entering parameter values.

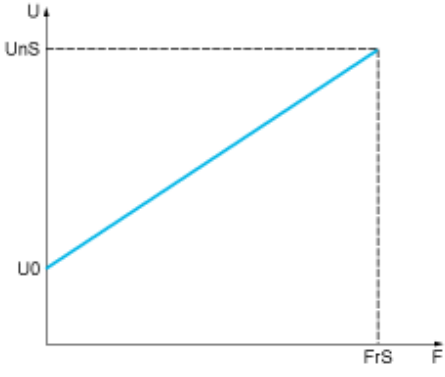
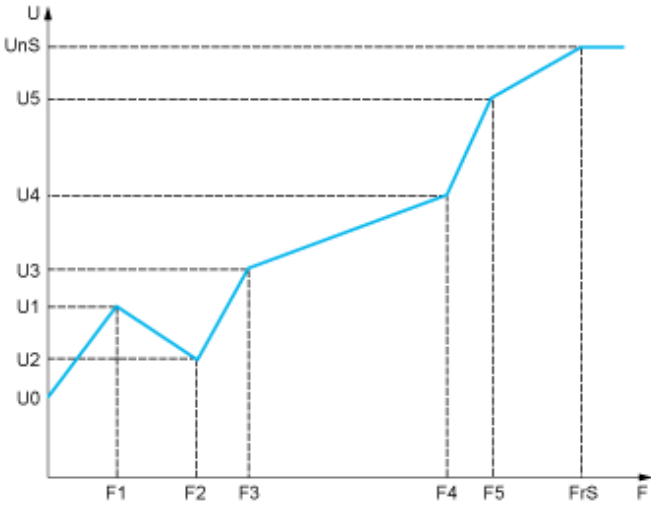
Setting	Code / Value	Description
[U/F VC Standard]	<i>U F U</i>	<p>Standard motor control type. For applications that require torque at low speed. Simple motor control type keeping a constant Voltage Frequency ratio, with a possible adjustment of the curve bottom. This motor control type is used for motors connected in parallel.</p>  <p>NOTE: U0 is the result of an internal calculation based on motor parameters and multiplied by <i>U F r</i> (%). U0 can be adjusted by modifying <i>U F r</i> value.</p>
[U/F VC 5pts]	<i>U F 5</i>	<p>5-segment V/F profile: As [U/F VC Standard] <i>U F U</i> profile but also supports the avoidance of resonance (saturation).</p>  <p>The profile is defined by the values of parameters <i>U n S</i>, <i>F r S</i>, <i>U 1</i> to <i>U 5</i> and <i>F 1</i> to <i>F 5</i>. $F r S > F 5 > F 4 > F 3 > F 2 > F 1$</p> <p>NOTE: U0 is the result of an internal calculation based on motor parameters and multiplied by <i>U F r</i> (%). U0 can be adjusted by modifying <i>U F r</i> value.</p>
[U/F VC Quad.]	<i>U F 9</i>	<p>Motor control type dedicated to variable torque applications, typically used for pumps and fans. Factory setting</p>
[SYN_U VC]	<i>S Y n U</i>	<p>Motor control type specific for permanent magnet synchronous motors. Upcoming marketing</p>
[U/F VC Energy Sav.]	<i>E C o</i>	<p>Specific motor control type optimized for energy saving.</p>

[U/F Profile] PFL ★

U/F profile.

This parameter can be accessed if **[Motor Control Type] CLE** is set to **[U/F VC Quad.] UF9**.

This parameter is used to adjust the fluxing current level at zero speed, in % of nominal motor current at nominal speed.

Setting ()	Description
0...100%	Setting range Factory setting: 30%

[U1] U1 ★

Voltage point 1 on 5 points V/F.

This parameter can be accessed if **[Motor Control Type] CLE** is set to **[V/F 5pts] UF5**.

Setting ()	Description
0...800 V	Setting range according to rating Factory setting: 0 V

[F1] F1 ★

Frequency point 1 on 5 points V/F.

V/F profile setting.

This parameter can be accessed if **[Motor Control Type] CLE** is set to **[V/F 5pts] UF5**.

Setting ()	Description
0.0...500.0 Hz	Setting range Factory setting: 0.0 Hz

[U2] U2 ★

Voltage point 2 on 5 points V/F.

V/F profile setting.

This parameter can be accessed if **[Motor Control Type] CLE** is set to **[V/F 5pts] UF5**.

Setting ()	Description
0...800 V	Setting range according to rating Factory setting: 0 V

[F2] F2 ★

Frequency point 2 on 5 points V/F.

V/F profile setting.

This parameter can be accessed if **[Motor Control Type] CLE** is set to **[V/F 5pts] UF5**.

Setting ()	Description
0.0...500.0 Hz	Setting range Factory setting: 0.0 Hz

[U3] U3 ★

Voltage point 3 on 5 points V/F.

V/F profile setting.

This parameter can be accessed if **[Motor Control Type] CLE** is set to **[V/F 5pts] UF5**.

Setting ()	Description
0...800 V	Setting range according to rating Factory setting: 0 V

[F3] F 3 ★

Frequency point 3 on 5 points V/F.

V/F profile setting.

This parameter can be accessed if **[Motor Control Type] C E E** is set to **[V/F 5pts] u F 5**.

Setting ()	Description
0.0...500.0 Hz	Setting range Factory setting: 0.0 Hz

[U4] u 4 ★

Voltage point on 4 points V/F.

V/F profile setting.

This parameter can be accessed if **[Motor Control Type] C E E** is set to **[V/F 5pts] u F 5**.

Setting ()	Description
0...800 V	Setting range according to rating Factory setting: 0 V

[F4] F 4 ★

Frequency point 4 on 5 points V/F.

V/F profile setting.

This parameter can be accessed if **[Motor Control Type] C E E** is set to **[V/F 5pts] u F 5**.

Setting ()	Description
0.0...500.0 Hz	Setting range Factory setting: 0.0 Hz

[U5] u 5 ★

Voltage point 5 on 5 points V/F.

V/F profile setting.

This parameter can be accessed if **[Motor Control Type] C E E** is set to **[V/F 5pts] u F 5**.

Setting ()	Description
0...800 V	Setting range according to rating Factory setting: 0 V

[F5] F 5 ★

Frequency point 5 on 5 points V/F.

V/F profile setting.

This parameter can be accessed if **[Motor Control Type] C E E** is set to **[V/F 5pts] u F 5**.

Setting ()	Description
0.0...500.0 Hz	Setting range Factory setting: 0.0 Hz

[IR compensation] u F r

This parameter is used to optimize torque at low speed, or to adapt to special cases (for example: for motors connected in parallel, decrease **[IR compensation] u F r**). If there is insufficient torque at low speed, increase **[IR compensation] u F r**. A too high value can avoid the motor to start (locking) or change the current limiting mode.

Setting ()	Description
0...200%	Setting range Factory setting: 100%

[Slip compensation] 5 L P ★

Slip compensation.

This parameter cannot be accessed if **[Motor Control Type] C E E** is set to **[SYN_U VC] 5 Y n u**.

This parameter is set to 0% when **[Motor Control Type] C E E** is set to **[U/F VC Quad.] u F 9**.

The speeds given on motor nameplates are not necessarily exact.

If the slip setting is lower than the actual slip, the motor is not rotating at the correct speed in steady state, but at a lower speed than the reference.

If the slip setting is higher than the actual slip, the motor is overcompensated and the speed is unstable.

Setting ()	Description
0...300%	Setting range Factory setting: 100%

[Switching frequency] 5 F r

Drive switching frequency.

NOTICE**DAMAGE TO THE DRIVE**

Verify that the switching frequency of the drive does not exceed 4 kHz if the EMC filter is disconnected for operation of the drive in an IT mains.

Failure to follow these instructions can result in equipment damage.

Adjustment range: The maximum value is limited to 4 kHz if **[Motor surge limit.] 5 u L** parameter is configured.

If **[Sinus Filter Activation] a F i** is set to **[Yes] 5 E 5**, the minimum value is 2 kHz and the maximum value is limited to 6 kHz or 8 kHz according to drive rating.

NOTE: In the event of excessive temperature rise, the drive automatically reduces the switching frequency and reset it once the temperature returns to normal.

In case of high-speed motor, it is advised to increase the PWM frequency **[Switching frequency] 5 F r** at 8, 12 kHz or 16 kHz

Setting ()	Description
1...8 or 16 kHz according to drive rating	Setting range Factory setting: 4.0 kHz or 2.5 kHz according to the drive rating

[Switch Freq Type] 5 F E ★

Switching frequency type.

This parameter can be accessed if **[Access Level] L R C** is set to **[Expert] E P r**.

The motor switching frequency is modified (reduced) when the internal temperature of the drive is too high.

Setting ()	Code / Value	Description
[SFR type 1]	H F 1	Heating optimization Allows the system to adapt the switching frequency according to the motor frequency. This setting optimizes the heating loss of the drive in order to improve the drive efficiency. Factory setting
[SFR type 2]	H F 2	Allows the system to keep a constant chosen switching frequency [Switching frequency] 5 F r whatever the motor frequency [Output frequency] r F r . With this setting, the motor noise is kept as low as possible for a high switching frequency. In the event of overheating, the drive automatically decreases the switching frequency. It is restored to its original value when the temperature returns to normal.

[Noise Reduction] *n r d*

Motor noise reduction.

Random frequency modulation helps to prevent any resonance, which may occur at a fixed frequency.

Setting	Code / Value	Description
[No]	<i>n o</i>	Fixed frequency Factory setting
[Yes]	<i>y e s</i>	Frequency with random modulation

[Motor Surge Limit.] *s u l*

Surge voltage limitation.

This function limits motor over voltages and is useful in the following applications:

- NEMA motors
- Old or poor quality motors
- Spindle motors
- Rewound motors

This parameter can remain set to **[No] *n o*** for 230/400 Vac motors used at 230 Vac, or if the length of cable between the drive and the motor does not exceed:

- 4 m with unshielded cables
- 10 m with shielded cables

NOTE: When **[Motor Surge Limit.] *s u l*** is set to **[Yes] *y e s***, the maximum switching frequency **[Switching freq.] *s f r*** is modified.

Setting	Code / Value	Description
[No]	<i>n o</i>	Function inactive Factory setting
[Yes]	<i>y e s</i>	Function active

[Attenuation Time] *s o p* ★

Attenuation time.

The value of the **[Volt surge limit. opt] *s o p*** parameter corresponds to the attenuation time of the cable used. It has been defined to prevent the superimposition of voltage wave reflections resulting from long cable lengths. It limits over voltages to twice the DC bus rated voltage.

As surge voltage depends on many parameters such as types of cable, different motor powers in parallel, different cable lengths in parallel, etc., we recommend using an oscilloscope to check the over voltage values obtained at the motor terminals.

For long cable lengths, an output of the filter or a dV/dt protection filter must be used.

To retain the overall drive performance, do not increase the ***s o p*** value unnecessarily.

Setting	Code / Value	Description
[6]	<i>6</i>	6 μs
[8]	<i>8</i>	8 μs Factory setting
[10]	<i>10</i>	10 μs

[Current Limitation] $C L$, ★

Internal current limit.

NOTICE**OVERHEATING AND DAMAGE TO THE MOTOR**

- Verify that the motor is properly rated for the maximum current to be applied to the motor.
- Consider the duty cycle of the motor and all factors of your application including derating requirements in determining the current limit.

Failure to follow these instructions can result in equipment damage.

NOTE: If the setting is less than 0.25. In, the drive may lock in **[OutPhaseLoss Assign] $o P L$** if this has been enabled. If it is less than the no-load motor current, the motor cannot run.

Setting ()	Description
0...1.2 In ⁽¹⁾	Setting range Factory setting: 1.2 In ⁽¹⁾
(1) Corresponding to the rated drive current indicated in the installation manual and on the drive nameplate.	

[Autotuning] $t u n$ **  DANGER****HAZARD OF ELECTRIC SHOCK OR ARC FLASH**

During **[Autotuning] $t u n$** , the motor operates at nominal current.

- Verify that the same precautions are in place during **[Autotuning] $t u n$** as during normal operation of the motor as specified in product manuals and in the manual of the motor.

Failure to follow these instructions will result in death or serious injury.

 WARNING**LOSS OF CONTROL**

- The parameters **[Nom Motor Voltage] $u n S$** , **[Nominal Motor Freq] $F r S$** , **[Nom Motor Current] $n C r$** , **[Nominal Motor Speed] $n S P$** , and **[Nominal motor power] $n P r$** or **[Motor 1 Cosinus Phi] $C o S$** must be correctly set before starting autotuning.
- When one or more of these parameters have been changed after autotuning has been performed, **[Autotuning] $t u n$** will return **$n o$** and the autotuning will have to be repeated.

Failure to follow these instructions can result in death, serious injury, or equipment damage.

In any case, the motor has to be stopped before performing a tune operation. Verify that the application does not make the motor turn during the tune operation.

The tune operation optimizes:

- The motor performances at low speed.
- The estimation of the motor torque.
- The accuracy of the estimation of the process values in sensorless operation and monitoring.

Autotuning is only performed if no stop command has been activated. If a “freewheel stop” or “fast stop” function has been assigned to a digital input, this input must be set to 1 (active at 0).

Autotuning takes priority over any run or prefluxing commands, which will be taken into account after the autotuning sequence.

If autotuning has detected error, the drive always displays **[No action] $n o$** and, depending on the configuration of **[Tuning Error Resp] $t n L$** , may switch to **[Autotuning] $t u n$** detected error mode.

Autotuning may last for several seconds. Do not interrupt the process. Wait for the Plain Text Display Terminal to change to **[No action] $n o$** .

NOTE: The motor thermal state has a significant influence on the tuning result. Always perform a motor tuning with the motor stopped and cold. Verify that the application does not have the motor operate during a tuning operation.

To redo a motor tuning, wait that it is stopped and cold. Set first **[Autotuning] t u n** to **[Erase Autotuning] C L r**, then redo the motor tuning.

The use of the motor tuning without doing a **[Erase Autotuning] C L r** first is used to get the thermal state estimation of the motor.

The cable length has an influence on the tune result. If the wiring is modified, it is necessary to redo the tune operation.

Setting ()	Code / Value	Description
[No action]	<i>n o</i>	Autotuning not in progress Factory setting
[Apply Autotuning]	<i>y E 5</i>	Autotuning is performed immediately if possible, then the parameter automatically changes to [No action] n o . If the drive state does not allow the tune operation immediately, the parameter changes to [No] n o and the operation must be done again.
[Erase Autotuning]	<i>C L r</i>	The motor parameters measured by the autotuning function are reset. The default motor parameter values are used to control the motor. [Autotuning Status] t u 5 is set to [Not done] t A b .

[Autotuning Status] t u 5

Autotuning status.

(for information only, cannot be modified)

This parameter is not saved at drive power-off. It shows the autotuning status since the last power-on.

Setting ()	Code / Value	Description
[Not done]	<i>t A b</i>	The autotuning is not done Factory setting
[Pending]	<i>P E n d</i>	The autotuning has been requested but not yet performed
[In Progress]	<i>P r o G</i>	The autotuning is in progress
[Failed]	<i>F A i L</i>	The autotuning has detected an error
[Done]	<i>d o n E</i>	The motor parameters measured by the autotuning function are used to control the motor

Section 6.2

[Input/Output]

What Is in This Section?

This section contains the following topics:

Topic	Page
[Input/Output] , 0 - Menu	98
[DI1 Assignment] L , 1 C - Menu	100
[DI2 Assignment] L , 2 C - Menu	102
[DI3 Assignment] L , 3 C - Menu	103
[DI4 Assignment] L , 4 C - Menu	104
[DI5 Assignment] L , 5 C - Menu	105
[DI6 Assignment] L , 6 C - Menu	106
[DI11 Assignment] d , 1 1 - Menu	107
[DI11 Assignment] d , 1 2 - Menu	108
[DI13 Assignment] d , 1 3 - Menu	109
[DI14 Assignment] d , 1 4 - Menu	110
[DI15 Assignment] d , 1 5 - Menu	111
[DI16 Assignment] d , 1 6 - Menu	112
[Configuration DQ11] d 0 1 1 - Menu	113
[Configuration DQ12] d 0 1 2 - Menu	117
[Input/Output] , 0 - Menu	118
[AI1 configuration] A , 1 - Menu	120
[AI2 configuration] A , 2 - Menu	123
[AI3 configuration] A , 3 - Menu	124
[AI4 configuration] A , 4 - Menu	125
[AI5 configuration] A , 5 - Menu	127
[Virtual AI1] A 0 1 - Menu	128
[R1 configuration] r 1 - Menu	129
[R2 configuration] r 2 - Menu	132
[R3 configuration] r 3 - Menu	133
[R4 configuration] r 4 - Menu	134
[R5 configuration] r 5 - Menu	135
[R6 configuration] r 6 - Menu	136
[AQ1 configuration] A 0 1 - Menu	137
[AQ2 configuration] A 0 2 - Menu	141

[Input/Output] 1 0 - Menu

Access

[Complete settings] → [Input/Output]

About This Menu

[2/3-wire control] 2 3 

2-wire or 3-wire control.

 WARNING
<p>UNANTICIPATED EQUIPMENT OPERATION</p> <p>If this parameter is changed, the parameters [Reverse Assign] 4 5 and [2-wire type] 2 3 and the assignments of the digital inputs are reset to the factory setting.</p> <p>Verify that this change is compatible with the type of wiring used.</p> <p>Failure to follow these instructions can result in death, serious injury, or equipment damage.</p>

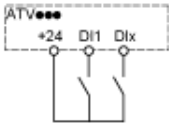
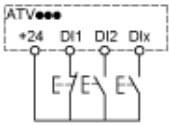
Setting	Code / Value	Description
[2-Wire Control]	2 3	<p>2-wire control (level commands): This is the input state (0 or 1) or edge (0 to 1 or 1 to 0), which controls running or stopping.</p> <p>Example of source wiring:</p> <div style="text-align: center; margin: 10px 0;">  </div> <p>DI1 Forward DIx Reverse</p> <p>Factory setting</p>
[3-Wire Control]	3 3	<p>3-wire control (pulse commands) [3 wire]: A forward or reverse pulse is sufficient to command starting, a stop pulse is sufficient to command stopping.</p> <p>Example of source wiring:</p> <div style="text-align: center; margin: 10px 0;">  </div> <p>DI1 Stop DI2 Forward DIx Reverse</p>

[2-wire type] Ɛ Ɛ Ɛ ★ ⏳

Type of 2-wire control.

This parameter can be accessed if **[2/3-wire control] Ɛ Ɛ Ɛ** is set to **[2-Wire Control] Ʒ Ɛ**.

⚠ WARNING**UNANTICIPATED EQUIPMENT OPERATION**

Verify that the parameter setting is compatible with the type of wiring used.

Failure to follow these instructions can result in death, serious injury, or equipment damage.

Setting	Code / Value	Description
[Level]	<i>L E L</i>	State 0 or 1 is taken into account for run (1) or stop (0)
[Transition]	<i>Ɛ r n</i>	A change of state (transition or edge) is necessary to initiate operation in order to avoid accidental restarts after a break in the supply mains Factory setting
[Level With Fwd Priority]	<i>P F ƚ</i>	State 0 or 1 is taken into account for run or stop, but the “forward” input takes priority over the “reverse” input

[Reverse Assign] r r 5

Reverse assignment.

Setting	Code / Value	Description
[Not Assigned]	<i>n ƚ</i>	Not assigned Factory setting
[DI1]...[DI6]	<i>L , l ... L , 6</i>	Digital input DI1...DI6
[DI11]...[DI16]	<i>L , l l l ... L , 16</i>	Digital input DI11...DI16 if VW3A3203 I/O extension module has been inserted
[CD00]...[CD10]	<i>C d 0 0 ... C d 1 0</i>	Virtual digital input CMD.0...CMD.10 in [I/O profile] , ƚ configuration
[CD11]...[CD15]	<i>C d 1 1 ... C d 1 5</i>	Virtual digital input CMD.11...CMD.15 regardless of configuration
[C100]...[C110]	<i>C 1 0 0 ... C 1 1 0</i>	Virtual digital input CMD1.0...CMD1.10 with integrated Modbus Serial in [I/O profile] , ƚ configuration
[C111]...[C115]	<i>C 1 1 1 ... C 1 1 5</i>	Virtual digital input CMD1.11...CMD1.15 with integrated Modbus Serial regardless of configuration
[C300]...[C310]	<i>C 3 0 0 ... C 3 1 0</i>	Virtual digital input CMD3.0...CMD3.10 with a fieldbus module in [I/O profile] , ƚ configuration
[C311]...[C315]	<i>C 3 1 1 ... C 3 1 5</i>	Virtual digital input CMD3.11...CMD3.15 with a fieldbus module regardless of configuration

[DI1 Assignment] L , / C - Menu**Access****[Complete settings] → [Input/Output] → [DI1 Assignment]****[DI1 Low Assignment] L / L**

DI1 low assignment.

Setting	Code / Value	Description
[No]	<i>n o</i>	Not assigned Factory setting
[Run]	<i>r u n</i>	Run enable
[Forward]	<i>F r d</i>	Forward operation
[Reverse]	<i>r r 5</i>	Reverse operation
[Ramp switching]	<i>r P 5</i>	Ramp switching
[+Speed]	<i>u 5 P</i>	+ speed
[- speed]	<i>d 5 P</i>	- Speed
[2 preset speeds]	<i>P 5 2</i>	2 preset speeds
[4 preset speeds]	<i>P 5 4</i>	4 preset speeds
[8 preset speeds]	<i>P 5 8</i>	8 preset speeds
[Ref. 2 switching]	<i>r F C</i>	Reference switching
[Freewheel stop]	<i>n 5 t</i>	Freewheel stop
[DC injection]	<i>d C ,</i>	Injection DC stop
[Fast stop]	<i>F 5 t</i>	Fast stop
[Forced local]	<i>F L o</i>	Forced local mode
[Fault reset]	<i>r 5 F</i>	Fault reset
[Autotuning Assign]	<i>t u L</i>	Autotuning assignment
[Auto / manual]	<i>P A u</i>	Auto / Manual switch
[PID integral reset]	<i>P , 5</i>	Integral shunting PID
[2 preset PID ref.]	<i>P r 2</i>	2 preset PID references
[4 preset PID ref.]	<i>P r 4</i>	4 preset PID references
[Torque limitation]	<i>t L A</i>	Permanent torque limitation
[External Error]	<i>E t F</i>	External error
[2 parameter sets]	<i>C H A 1</i>	Parameter switching 1
[3 parameter sets]	<i>C H A 2</i>	Parameter switching 2
[Cmd switching]	<i>C C 5</i>	Command channel switching
[Error Detection Disable]	<i>, n H</i>	Error Detection Disable
[16 preset speeds]	<i>P 5 1 6</i>	16 preset speeds
[Ref 1B switching]	<i>r C b</i>	Reference channel switching (1 to 1B)
[Drive Lock]	<i>L E 5</i>	Drive lock assignment
[ProductReset Assign]	<i>r P A</i>	Reset product
[Idle]	<i>, d L 5</i>	Stop and go : idle mode enable condition
[R1]...[R3]	<i>r 1...r 3</i>	Relay output R1...R3
[R4]...[R6]	<i>r 4...r 6</i>	Relay output R4...R5 if VW3A3204 relay output option module has been inserted

Setting	Code / Value	Description
[Analog output DQ11]...[Analog output DQ12]	<i>d o 1 1...d o 1 2</i>	Analog / digital output DO11...DO12 if VW3A3203 I/O extension module has been inserted
[Preset spd2]	<i>F P S 1</i>	Function key preset speed 1 assignment
[Preset spd3]	<i>F P S 2</i>	Function key preset speed 2 assignment
[PID ref. 2]	<i>F P r 1</i>	Function key preset PI 1 assignment
[PID ref. 3]	<i>F P r 2</i>	Function key preset PI 2 assignment
[+Speed]	<i>F u S P</i>	Function key faster assignment
[-Speed]	<i>F d S P</i>	Function key slower assignment
[T/K]	<i>F t</i>	Function key bumpless assignment

[DI1 High Assignment] L I H

DI1 high assignment.

Identical to low assignment.

[D1 Delay] L I d

DI1 delay.

NOTE: Commands received via this digital input are processed once the delay time set via this parameter has elapsed.

Setting	Description
0...200 ms	Setting range Factory setting: 0 ms

[DI2 Assignment] L 1 2 C - Menu

Access

[Complete settings] → [Input/Output] → [DI2 Assignment]

About This Menu

Identical to [DI1 Assignment] L 1 1 C - menu (*see page 100*).

[DI2 Low Assignment] L 2 L

DI2 low assignment.

[DI2 High Assignment] L 2 H

DI2 high assignment.

[DI2 Delay] L 2 d

DI2 delay.

[DI3 Assignment] L , 3 C - Menu

Access

[Complete settings] → [Input/Output] → [DI3 Assignment]

About This Menu

Identical to [DI1 Assignment] L , 1 C - menu (*see page 100*).

[DI3 Low Assignment] L 3 L

DI3 low assignment.

[DI3 High Assignment] L 3 H

DI3 high assignment.

[DI3 Delay] L 3 d

DI3 delay.

[DI4 Assignment] L 4 C - Menu

Access

[Complete settings] → [Input/Output] → [DI4 Assignment]

About This Menu

Identical to [DI1 Assignment] L 1 C - menu (*see page 100*).

[DI4 Low Assignment] L 4 L

DI4 low assignment.

[DI4 High Assignment] L 4 H

DI4 high assignment.

[DI4 Delay] L 4 d

DI4 delay.

[DI5 Assignment] L 5 C - Menu

Access

[Complete settings] → [Input/Output] → [DI5 Assignment]

About This Menu

Identical to [DI1 Assignment] L 1 C - menu (*see page 100*).

[DI5 Low Assignment] L 5 L

DI5 low assignment.

[DI5 High Assignment] L 5 H

DI5 high assignment.

[DI5 Delay] L 5 d

DI5 delay.

[DI6 Assignment] L , B C - Menu

Access

[Complete settings] → [Input/Output] → [DI6 Assignment]

About This Menu

Identical to **[DI1 Assignment] L , I C** - menu (*see page 100*).

[DI6 Low Assignment] L B L

DI6 low assignment.

[DI6 High Assignment] L B H

DI6 high assignment.

[DI6 Delay] L B d

DI6 delay.

[DI11 Assignment] - Menu

Access

[Complete settings] → [Input/Output] → [DI11 Assignment]

About This Menu

Identical to [DI1 Assignment]  - menu (*see page 100*).

[DI11 Low Assignment] ★

DI11 low assignment.

[DI11 High Assignment] ★

DI11 high assignment.

[DI11 Delay] ★

DI11 delay.

[DI11 Assignment] *d* , *I2* - Menu

Access

[Complete settings] → [Input/Output] → [DI12 Assignment]

About This Menu

Identical to [DI1 Assignment] *L* , *IC* - menu (*see page 100*).

[DI12 Low Assignment] *L I2L* ★

DI12 low assignment.

[DI12 High Assignment] *L I2H* ★

DI12 high assignment.

[DI12 Delay] *L I2d* ★

DI12 delay.

[DI13 Assignment] *d , l 3* - Menu

Access

[Complete settings] → [Input/Output] → [DI13 Assignment]

About This Menu

Identical to [DI1 Assignment] *L , l E* - menu (*see page 100*).

[DI13 Low Assignment] *L l 3 L* ★

DI13 low assignment.

[DI13 High Assignment] *L l 3 H* ★

DI13 high assignment.

[DI13 Delay] *L l 3 d* ★

DI13 delay.

[DI14 Assignment] *d* , *14* - Menu

Access

[Complete settings] → [Input/Output] → [DI14 Assignment]

About This Menu

Identical to [DI1 Assignment] *L* , *1C* - menu (*see page 100*).

[DI14 Low Assignment] *L 14L* ★

DI14 low assignment.

[DI14 High Assignment] *L 14H* ★

DI14 high assignment.

[DI14 Delay] *L 14d* ★

DI14 delay.

[DI15 Assignment] *d* , *IS* - Menu

Access

[Complete settings] → [Input/Output] → [DI15 Assignment]

About This Menu

Identical to [DI1 Assignment] *L* , *IE* - menu (*see page 100*).

[DI15 Low Assignment] *L ISL* ★

DI15 low assignment.

[DI15 High Assignment] *L ISH* ★

DI15 high assignment.

[DI15 Delay] *L ISd* ★

DI15 delay.

[DI16 Assignment] *d* , *IE* - Menu

Access

[Complete settings] → [Input/Output] → [DI16 Assignment]

About This Menu

Identical to [DI1 Assignment] *L* , *IC* - menu (*see page 100*).

[DI16 Low Assignment] *L IE L* ★

DI16 low assignment.

[DI16 High Assignment] *L IE H* ★

DI16 high assignment.

[DI16 Delay] *L IE d* ★

DI16 delay.

[Configuration DQ11] d o | | - Menu**Access**

[Complete settings] → [Input/Output] → [Configuration DQ11]

About This Menu

Following parameters can be accessed if VW3A3203 I/O extension module has been inserted.

[DQ11 Assignment] d o | | ★

Digital output 11 assignment.

Setting	Code / Value	Description
[No]	n o	Not assigned Factory setting
[Operating State "Fault"]	F L t	Drive operating state fault
[Drive Running]	r u n	Drive run
[Motor Freq High Thd]	F t R	Motor frequency threshold reached
[High speed reached]	F L R	High speed reached
[Current Thd Reached]	C t R	Motor current threshold reached
[Ref Freq Reached]	S r R	Frequency reference reached
[Motor Therm Thd reached]	t S R	Motor thermal threshold reached
[PID error Warning]	P E E	PID error warning
[PID feedback Warning]	P F R	PID feedback warning
[AI2 4-20 Loss Warning]	A P 2	AI2 4-20 mA loss warning
[2nd Frequency Thd Reached]	F 2 R	Second frequency threshold reached
[Drive Thermal Thd reached]	t R d	Drive thermal threshold reached
[Ref Freq High Thd reached]	r t R H	Frequency reference high threshold reached
[Ref Freq Low Thd reached]	r t R L	Frequency reference low threshold reached
[Motor Freq Low Thd]	F t R L	Frequency low threshold reached
[Motor Freq Low Thd 2]	F 2 R L	Second frequency low threshold reached
[Low Current Reached]	C t R L	Current low threshold reached
[Process Underload Warning]	u L R	Underload warning
[Process Overload Warning]	o L R	Overload warning
[PID High Feedback Warning]	P F R H	PID feedback high threshold reached
[PID Low Feedback Warning]	P F R L	PID feedback low threshold reached

Setting	Code / Value	Description
[Regulation Warning]	<i>P r S H</i>	PID regulation unable to reach the set point
[High Torque Warning]	<i>t t H R</i>	High torque threshold reached
[Low Torque Warning]	<i>t t L R</i>	Low torque threshold reached
[Forward]	<i>Π F r d</i>	Run forward
[Reverse]	<i>Π r r S</i>	Run reverse
[Ramp Switching]	<i>r P 2</i>	Ramp switching state
[Neg Torque]	<i>R t S</i>	Actual torque sign
[Cnfg.0 act.]	<i>C n F 0</i>	Configuration 0 active
[Cnfg.2 act.]	<i>C n F 2</i>	Configuration 2 active
[set 1 active]	<i>C F P 1</i>	Parameter set 1 active
[set 2 active]	<i>C F P 2</i>	Parameter set 2 active
[set 3 active]	<i>C F P 3</i>	Parameter set 3 active
[set 4 active]	<i>C F P 4</i>	Parameter set 4 active
[DC Charged]	<i>d b L</i>	DC bus loaded
[Motor Freq High Thd 2]	<i>F 9 L R</i>	Frequency level reached
[Mains Contactor]	<i>L L C</i>	Line contactor activated
[I present]	<i>Π C P</i>	Motor current present
[Warning group 1]	<i>R G 1</i>	Warning group 1
[Warning group 2]	<i>R G 2</i>	Warning group 2
[Warning group 3]	<i>R G 3</i>	Warning group 3
[Ext. Error Warning]	<i>E F R</i>	External error warning
[Undervoltage Warning]	<i>u S R</i>	Undervoltage warning
[Preventive Undervolt Active]	<i>u P R</i>	Undervoltage prevention warning
[Drive Thermal Warning]	<i>t H R</i>	Drive thermal state warning
[Ref Freq Channel 1]	<i>F r 1</i>	Reference channel = channel 1
[Ref Freq Channel 2]	<i>F r 2</i>	Reference channel = channel 2
[Command Channel 1]	<i>C d 1</i>	Command channel = channel 1
[Command Channel 2]	<i>C d 2</i>	Command channel = channel 2
[ch1B active]	<i>F r 1 b</i>	Reference channel = channel 1B
[IGBT Thermal Warning]	<i>t J R</i>	Thermal junction warning
[AI3 4-20 Loss Warning]	<i>R P 3</i>	AI3 4-20 mA loss warning
[AI4 4-20 Loss Warning]	<i>R P 4</i>	AI4 4-20 mA loss warning
[Flow Limit Active]	<i>F S R</i>	Flow limitation function activated
[Function key 1]	<i>F n 1</i>	Function key 1
[Function key 2]	<i>F n 2</i>	Function key 2
[Function key 3]	<i>F n 3</i>	Function key 3

Setting	Code / Value	Description
[Function key 4]	<i>F n 4</i>	Function key 4
[AI1 4-20 Loss Warning]	<i>RP 1</i>	AI1 4-20 mA loss alarm
[Ready]	<i>r d 4</i>	Ready to start
[Warning Group 4]	<i>RG 4</i>	Warning group 4
[Warning Group 5]	<i>RG 5</i>	Warning group 5
[Fallback Speed]	<i>F r F</i>	Reaction on event / fallback speed
[Per Type of Stop]	<i>5 E E</i>	Reaction on event / stop on [Type of stop] <i>5 E E</i> without error
[Life Cycle Warning 1]	<i>L C R 1</i>	Life cycle warning 1
[Life Cycle Warning 2]	<i>L C R 2</i>	Life cycle warning 2
[AI2 Th Warning]	<i>t P 2 R</i>	Thermal 2 Warning
[AI3 Th Warning]	<i>t P 3 R</i>	Thermal 3 Warning
[AI4 Th Warning]	<i>t P 4 R</i>	Thermal 4 Warning
[AI5 Th Warning]	<i>t P 5 R</i>	Thermal 5 Warning
[AI5 4-20 Loss Warning]	<i>RP 5</i>	AI5 4-20 mA loss warning
[Fan Counter Warning]	<i>F C E R</i>	Fan counter warning
[Fan Feedback Warning]	<i>F F d R</i>	Fan feedback warning
[Power High Threshold]	<i>P E H R</i>	Power high threshold
[Power Low Threshold]	<i>P E H R</i>	Power low threshold
[Cust warning 1]	<i>C R 5 1</i>	Customer warning 1
[Cust warning 2]	<i>C R 5 2</i>	Customer warning 2
[Cust warning 3]	<i>C R 5 3</i>	Customer warning 3
[Cust warning 4]	<i>C R 5 4</i>	Customer warning 4
[AI1 4-20 Loss Warning]	<i>RP 1</i>	AI1 4-20 mA loss warning

[DQ11 actv delay] *d l l d* ★

DO11 activation delay time.

The delay cannot be set for the **[Operating State "Fault"]** *F L E*, **[Brake Sequence]** *b L C*, **[Out. contactor ass.]** *d C C* and **[Mains Contactor]** *L L C* assignments, and remains at 0.

The change in state only takes effect once the configured time has elapsed when the information becomes true.

Setting	Description
0...60,000 ms	Setting range 0...9,999 ms then 10.00...60.00 s on the Plain Text Display Terminal Factory setting: 0 ms

[DQ11 status] *d / I / 5* ★

DO11 status (output active level).

Setting	Code / Value	Description
[1]	<i>P o 5</i>	State 1 when the information is true Factory Setting
[0]	<i>n E G</i>	State 0 when the information is true

The configuration [1] *P o 5* cannot be modified for the **[Operating State “Fault”]** *F L E*, **[Brake Sequence]** *b L C*, and **[Mains Contactor]** *L L C* assignments.

[DQ11 hold delay] *d / I / H* ★

DO11 holding delay time.

The holding time cannot be set for the **[Operating State “Fault”]** *F L E*, **[Brake Sequence]** *b L C*, and **[Mains Contactor]** *L L C* assignments, and remains at 0.

The change in state only takes effect once the configured time has elapsed when the information becomes false.

Setting	Description
0...9,999 ms	Setting range Factory setting: 0 ms

[Configuration DQ12] *d o 12* - Menu

Access

[Complete settings] → [Input/Output] → [Configuration DQ12]

About This Menu

Identical to [Configuration DQ11] *d o 11* - Menu (*see page 113*).

Following parameters can be accessed if VW3A3203 I/O extension module has been inserted.

[DQ12 Assignment] *d o 12* ★

Digital output 12 assignment.

[DQ12 actv delay] *d 12 d* ★

DO12 activation delay time.

[DQ12 status] *d 12 S* ★

DO12 status (output active level).

[DQ12 hold delay] *d 12 H* ★

DO12 holding delay time.

[Input/Output] *i d* - Menu

Access

[Complete settings] → [Input/Output]

About This Menu

[Ref Freq Template] *b 5 P*

Low speed management (template).

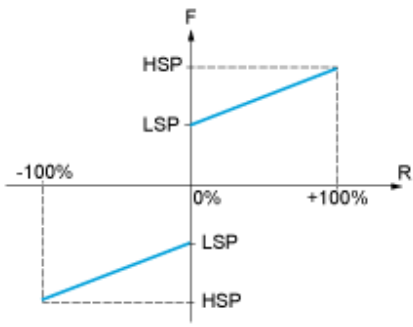
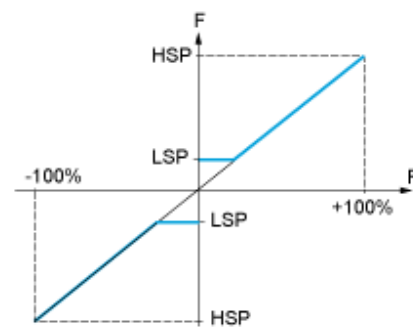
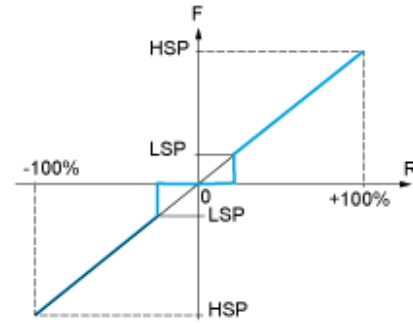
Setting 	Code / Value	Description
[Standard]	<i>b 5 d</i>	 <p>F Frequency R Reference</p> <p>At zero reference the frequency = LSP Factory setting</p>
[Pedestal]	<i>b L 5</i>	 <p>F Frequency R Reference</p> <p>At reference = 0 to LSP the frequency = LSP</p>
[Deadband]	<i>b n 5</i>	 <p>F Frequency R Reference</p> <p>At reference = 0 to LSP the frequency = 0</p>

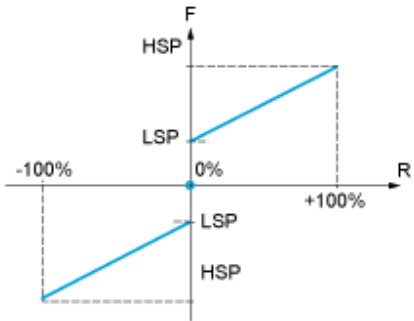
Setting 	Code / Value	Description
[Deadband 0]	<i>b n 5 0</i>	 <p>F Frequency R Reference</p> <p>This operation is the same as [Standard] b 5 d, except that in the following cases at zero reference, the frequency = 0: The signal is less than [Min nvalue], which is greater than 0 (example: 1 V on a 2–10 V input) The signal is greater than [Min nvalue], which is greater than [Max value] (example: 11 V on a 10–0 V input). If the input range is configured as “bidirectional”, operation remains identical to [Standard] b 5 d.</p> <p>This parameter defines how the speed reference is taken into account, for analog inputs and pulse input only. In the case of the PID regulator, this is the PID output reference. The limits are set by the [Low speed] L 5 P and [High speed] H 5 P parameters</p>

[AI1 configuration] R , I - Menu

Access

[Complete settings] → [Input/Output] → [AI1 configuration]

About This Menu

The input can be delinearized by configuring an intermediate point on the input/output curve of this input:

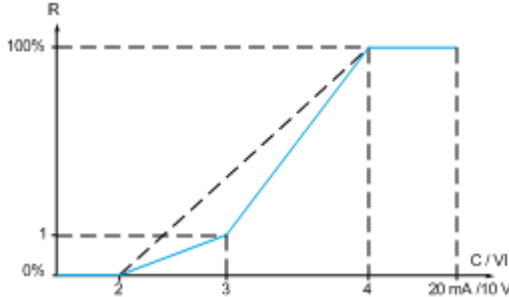

- R Reference
- C / VI Current or Voltage Input
- 1 [Interm. point Y]
- 2 [Min value] (0%)
- 3 [Interm. point X]
- 4 [Max value] (100%)

NOTE: For [Interm. point X], 0% corresponds to [Min value] and 100% to [Max value].

[AI1 Assignment] R , IA

AI1 functions assignment.

Setting	Code / Value	Description
[No]	n o	Not assigned
[AQ1 assignment]	R o 1	Analog output AO1
[AQ2 assignment]	R o 2	Analog output AO2
[ch1 active]	F r 1	Reference source 1
[ch2 active]	F r 2	Reference source 2
[Summing ref. 2]	S R 2	Summing reference 2
[PID feedback]	P , F	PID feedback (PID control)
[Subtract. ref. 2]	d R 2	Subtracting reference 2
[Manual PID ref.]	P , Π	Manual speed reference of the PID controller (auto-man)
[Speed ref. assign.]	F P ,	Speed reference of the PID controller (predictive reference)
[Summing ref. 3]	S R 3	Summing reference 3
[Ref.1B channel]	F r 1 b	Reference source 1B
[Subtract. ref. 3]	d R 3	Subtracting reference 3
[Forced local]	F L o C	Forced local reference source
[Ref.2 multiplier]	Π R 2	Multiplying reference 2
[Ref.3 multiplier]	Π R 3	Multiplying reference 3
[Weight input]	P E 5	Lift: external weight measurement function
[Virtual AI1 channel]	R , C 1	Virtual AI1 channel selector function
[PS1A]	P 5 1 R	Select the source of inlet pressure sensor
[PS2A]	P 5 2 R	Select the source of outlet pressure sensor
[Inst. Flow Assign.]	F 5 1 R	Select the source of installation flow sensor
[FS2A]	F 5 2 R	Select the source of pump flow sensor

[AI1 Type] R , I E

Configuration of analog input AI1.

Setting	Code / Value	Description
[Voltage]	I D u	0-10 Vdc Factory setting
[Current]	D R	0-20 mA

[AI1 min value] u , L I ★

AI1 voltage scaling parameter of 0%.

This parameter can be accessed if **[AI1 Type] R , I E** is set to **[Voltage] I D u**.

Setting	Description
0.0...10.0 V	Setting range Factory setting: 0.0 V

[AI1 max value] u , H I ★

AI1 voltage scaling parameter of 100%.

This parameter can be accessed if **[AI1 Type] R , I E** is set to **[Voltage] I D u**.

Setting	Description
0.0...10.0 V	Setting range Factory setting: 10.0 V

[AI1 min. value] C r L I ★

AI1 current scaling parameter of 0%.

This parameter can be accessed if **[AI1 Type] R , I E** is set to **[Current] D R**.

Setting	Description
0.0...20.0 mA	Setting range Factory setting: 0.0 mA

[AI1 max. value] C r H I ★

AI1 current scaling parameter of 100%.

This parameter can be accessed if **[AI1 Type] R , I E** is set to **[Current] D R**.

Setting	Description
0.0...20.0 mA	Setting range Factory setting: 20.0 mA

[AI1 filter] R , I F

AI1 cutoff time of the low filter.

Setting	Description
0.00...10.00 s	Setting range Factory setting: 0.00 s

[AI1 Interm. point X] (R , IE)

Input delinearization point coordinate. Percentage of the physical input signal.

0% corresponds to **[AI1 min value]** (μ IL)

100% corresponds to **[AI1 max value]** (μ IH)

Setting	Description
0...100%	Setting range Factory setting: 0%

[AI1 Interm. point Y] (R , IS)

Input delinearization point coordinate (frequency reference).

Percentage of the internal frequency reference corresponding to the **[AI1 Interm. point X]** (R , IE) percentage of physical input signal.

Setting	Description
0...100%	Setting range Factory setting: 0%

[AI2 configuration] R , 2 - Menu

Access

[Complete settings] → [Input/Output] → [AI2 configuration]

[AI2 Assignment] R , 2 R

AI2 functions assignment.

Identical to [AI1 Assignment] R , 1 R (see page 120).

[AI2 Type] R , 2 E

Configuration of analog input AI2.

Setting	Code / Value	Description
[Voltage]	1 0 u	0-10 Vdc
[Current]	0 R	0-20 mA Factory setting
[PTC Management]	P E C	1 to 6 PTC (in serial)
[KTY]	K E Y	1 KTY84
[PT1000]	1 P E 3	1 PT1000 connected with 2 wires
[PT100]	1 P E 2	1 PT100 connected with 2 wires
[Water Prob]	L E u E L	Water level
[3PT1000]	3 P E 3	3 PT1000 connected with 2 wires
[3PT100]	3 P E 2	3 PT100 connected with 2 wires

[AI2 min value] u , L 2 ★

AI2 voltage scaling parameter of 0%.

This parameter can be accessed if [AI2 Type] R , 2 E is set to [Voltage] 1 0 u.

Identical to [AI1 min value] u , L 1 (see page 121).

[AI2 max value] u , H 2 ★

AI2 voltage scaling parameter of 100%.

This parameter can be accessed if [AI2 Type] R , 2 E is set to [Voltage] 1 0 u.

Identical to [AI1 max value] u , H 1 (see page 121).

[AI2 min. value] C r L 2 ★

AI2 current scaling parameter of 0%.

This parameter can be accessed if [AI2 Type] R , 2 E is set to [Current] 0 R.

Identical to [AI1 min. value] C r L 1 (see page 121) with factory setting: 4.0 mA.

[AI2 max. value] C r H 2 ★

AI2 current scaling parameter of 100%.

This parameter can be accessed if [AI2 Type] R , 2 E is set to [Current] 0 R.

Identical to [AI1 max. value] C r H 1 (see page 121).

[AI2 filter] R , 2 F

AI2 filter.

Identical to [AI1 filter] R , 1 F (see page 121).

[AI2 Interm. point X] R , 2 E

AI2 delinearization input level.

Identical to [AI1 Interm. point X] R , 1 E (see page 122).

[AI2 Interm. point Y] R , 2 S

AI2 delinearization output level.

Identical to [AI1 Interm. point Y] R , 1 S (see page 122).

[AI3 configuration] *R , 3 - Menu*

Access

[Complete settings] → [Input/Output] → [AI3 configuration]

[AI3 Assignment] *R , 3 R*

AI3 functions assignment.

Identical to [AI1 Assignment] *R , 1 R* (see page 120).

[AI3 Type] *R , 3 E*

Configuration of analog input AI3.

Identical to [AI2 Type] *R , 2 E* (see page 123).

[AI3 min value] *U , L 3 ★*

AI3 voltage scaling parameter of 0%.

Identical to [AI1 min value] *U , L 1* (see page 121).

This parameter can be accessed if [AI3 Type] *R , 3 E* is set to [Voltage] *1 0 U*.

[AI3 max value] *U , H 3 ★*

AI3 voltage scaling parameter of 100%.

Identical to [AI1 max value] *U , H 1* (see page 121).

This parameter can be accessed if [AI3 Type] *R , 3 E* is set to [Voltage] *1 0 U*.

[AI3 min. value] *C r L 3 ★*

AI3 current scaling parameter of 0%.

Identical to [AI1 min. value] *C r L 1* (see page 121).

This parameter can be accessed if [AI3 Type] *R , 3 E* is set to [Current] *0 R*.

[AI3 max. value] *C r H 3 ★*

AI3 current scaling parameter of 100%.

Identical to [AI1 max. value] *C r H 1* (see page 121).

This parameter can be accessed if [AI3 Type] *R , 3 E* is set to [Current] *0 R*.

[AI3 filter] *R , 3 F*

AI3 cutoff time of the low filter.

Identical to [AI1 filter] *R , 1 F* (see page 121).

[AI3 Interm. point X] *R , 3 E*

AI3 delinearization input level.

Identical to [AI1 Interm. point X] *R , 1 E* (see page 122).

[AI3 Interm. point Y] *R , 3 S*

AI3 delinearization output level.

Identical to [AI1 Interm. point Y] *R , 1 S* (see page 122).

[AI4 configuration] R , 4 - Menu**Access**

[Complete settings] → [Input/Output] → [AI4 configuration]

[AI4 Assignment] R , 4 R ★

AI4 functions assignment.

This parameter can be accessed if VW3A3203 relay output option module has been inserted.

Identical to [AI1 Assignment] R , 1 R (see page 120).

[AI4 Type] R , 4 E ★

Configuration of analog input AI4.

This parameter can be accessed if VW3A3203 relay output option module has been inserted.

Setting	Code / Value	Description
[Voltage]	1 0 u	0-10 Vdc
[Current]	0 R	0-20 mA
[Voltage +/-]	n 1 0 u	-10/+10 Vdc Factory setting
[PTC Management]	P E C	1 to 6 PTC (in serial)
[KTY]	K E Y	1 KTY84
[PT1000]	1 P E 3	1 PT1000 connected with 2 wires
[PT100]	1 P E 2	1 PT100 connected with 2 wires
[3 PT1000]	3 P E 3	3 PT1000 connected with 2 wires
[3 PT100]	3 P E 2	3 PT100 connected with 2 wires
[PT1000 in 3 wires]	1 P E 3 3	1 PT1000 connected with 3 wires (AI4 & AI5 only)
[PT100 in 3 wires]	1 P E 2 3	1 PT100 connected with 3 wires (AI4 & AI5 only)
[3 PT1000 in 3 wires]	3 P E 3 3	3 PT1000 connected with 3 wires (AI4 & AI5 only)
[3 PT100 in 3 wires]	3 P E 2 3	3 PT100 connected with 3 wires (AI4 & AI5 only)

[AI4 min value] u , L 4 ★

AI4 voltage scaling parameter of 0%.

Identical to [AI1 min value] u , L 1 (see page 121).

[AI4 max value] u , H 4 ★

AI4 voltage scaling parameter of 100%.

Identical to [AI1 max value] u , H 1 (see page 121).

[AI4 min. value] C r L 4 ★

AI4 current scaling parameter of 0%.

Identical to [AI1 min. value] C r L 1 (see page 121).

[AI4 max. value] C r H 4 ★

AI4 current scaling parameter of 100%.

Identical to [AI1 max. value] C r H 1 (see page 121).

[AI4 filter] R , 4 F ★

AI4 cutoff time of the low filter.

This parameter can be accessed if VW3A3203 relay output option module has been inserted.

Identical to **[AI1 filter] R , 1 F** (see page 121).

[AI4 Interm. point X] R , 4 E ★

AI4 delinearization input level.

This parameter can be accessed if VW3A3203 relay output option module has been inserted.

Identical to **[AI1 Interm. point X] R , 1 E** (see page 122).

[AI4 Interm. point Y] R , 4 S ★

AI4 delinearization output level.

This parameter can be accessed if VW3A3203 relay output option module has been inserted.

Identical to **[AI1 Interm. point Y] R , 1 S** (see page 122).

[AI5 configuration] R , 5 - Menu

Access

[Complete settings] → [Input/Output] → [AI5 configuration]

[AI5 Assignment] R , 5 R ★

AI5 functions assignment.

This parameter can be accessed if VW3A3203 relay output option module has been inserted.

Identical to [AI1 Assignment] R , 1 R (see page 120).

[AI5 Type] R , 5 E ★

Configuration of analog input AI5 .

This parameter can be accessed if VW3A3203 relay output option module has been inserted.

Identical to [AI4 Type] R , 4 E . (see page 125)

[AI5 min value] U , L 5 ★

AI5 voltage scaling parameter of 0%.

Identical to [AI1 min value] U , L 1 (see page 121).

[AI5 max value] U , H 5 ★

AI5 voltage scaling parameter of 100%.

Identical to [AI1 max value] U , H 1 (see page 121).

[AI5 min. value] C r L 5 ★

AI5 current scaling parameter of 0%.

Identical to [AI1 min. value] C r L 1 (see page 121).

[AI5 max. value] C r H 5 ★

AI5 current scaling parameter of 100%.

Identical to [AI1 max. value] C r H 1 (see page 121).

[AI5 filter] R , 5 F ★

AI5 cutoff time of the low filter.

This parameter can be accessed if VW3A3203 relay output option module has been inserted.

Identical to [AI1 filter] R , 1 F (see page 121).

[AI5 Interm. point X] R , 5 E ★

AI5 delinearization input level.

This parameter can be accessed if VW3A3203 relay output option module has been inserted.

Identical to [AI1 Interm. point X] R , 1 E (see page 122).

[AI5 Interm. point Y] R , 5 S ★

AI5 delinearization output level.

This parameter can be accessed if VW3A3203 relay output option module has been inserted.

Identical to [AI1 Interm. point Y] R , 1 S (see page 122).

[Virtual AI1] *R I* - Menu**Access**

[Complete settings] → [Input/Output] → [Virtual AI1]

[AIU1 Assignment] *R I A* ★

Virtual AI1 function assignment.

Setting	Code / Value	Description
[No]	<i>n o</i>	Not assigned
[AQ1 assignment]	<i>R o 1</i>	Analog output AQ1
[AQ2 assignment]	<i>R o 2</i>	Analog output AQ2
[ch1 active]	<i>F r 1</i>	Reference source 1
[ch2 active]	<i>F r 2</i>	Reference source 2
[Summing ref. 2]	<i>S R 2</i>	Summing reference 2
[PID feedback]	<i>P , F</i>	PID feedback (PID control)
[Subtract. ref. 2]	<i>d R 2</i>	Subtracting reference 2
[Manual PID ref.]	<i>P , Π</i>	Manual speed reference of the PID controller (auto-man)
[Speed ref. assign.]	<i>F P ,</i>	Speed reference of the PID controller (predictive reference)
[Summing ref. 3]	<i>S R 3</i>	Summing reference 3
[Ref.1B channel]	<i>F r 1 b</i>	Reference source 1B
[Subtract. ref. 3]	<i>d R 3</i>	Subtracting reference 3
[Forced local]	<i>F L o C</i>	Forced local reference source
[Ref.2 multiplier]	<i>Π R 2</i>	Multiplying reference 2
[Ref.3 multiplier]	<i>Π R 3</i>	Multiplying reference 3
[Virtual AI1 channel]	<i>R , C 1</i>	Virtual AI1 channel selector function
[Sel src inlet P Sens]	<i>P S 1 R</i>	Select the source of inlet pressure sensor
[OutletPres Assign]	<i>P S 2 R</i>	Select the source of outlet pressure sensor
[Sel src inlet P Sens]	<i>F S 1 R</i>	Select the source of installation flow sensor
[Sel src inlet P Sens]	<i>F S 2 R</i>	Select the source of pump flow sensor

[AIV1 Channel Assignment] *R , C 1*

Virtual analog input 1 assignment.

Setting	Code / Value	Description
[Not Configured]	<i>n o</i>	Not assigned Factory setting
[Ref.Frequency via Modbus]	<i>Π d b</i>	Modbus source
[Ref.Frequency via Com. Module]	<i>n E t</i>	Fieldbus module source

[R1 configuration] *r / - Menu***Access****[Complete settings] → [Input/Output] → [R1 configuration]****[R1 Assignment] *r /***

R1 assignment.

Setting	Code / Value	Description
[No]	<i>n o</i>	Not assigned Factory setting
[Operating State "Fault"]	<i>F L t</i>	Operating state fault
[Drive Running]	<i>r u n</i>	Drive running
[Output cont]	<i>o c c</i>	Downstream contactor running
[Freq.Th.att.]	<i>F t R</i>	Motor frequency threshold ([Motor Freq Thd] <i>F t d</i>) reached
[High speed reached]	<i>F L R</i>	High speed reached
[I attained]	<i>C t R</i>	Motor current threshold ([High Current Thd] <i>C t d</i>) reached
[Freq.ref.att]	<i>S r R</i>	Frequency reference reached
[Th.mot. att.]	<i>t S R</i>	Motor thermal threshold ([Motor Therm Thd] <i>t t d</i>) reached
[Brk control]	<i>b L C</i>	Braking sequence
[PID error al.]	<i>P E E</i>	PID error
[PID fdbk al.]	<i>P F R</i>	PID feedback warning
[AI2 4-20 Loss Warning]	<i>R P z</i>	AI2 4-20 mA loss warning
[FreqTh.att.2]	<i>F z R</i>	Second frequency threshold ([Freq. threshold 2] <i>F z d</i>) reached
[Th. drv. att.]	<i>t R d</i>	Drive thermal threshold reached
[High Ref.]	<i>r t R H</i>	Frequency reference high threshold reached
[Low Ref.]	<i>r t R L</i>	Frequency reference low threshold reached
[Low F.Thd.]	<i>F t R L</i>	Frequency low threshold ([Low Freq.Threshold] <i>F t d L</i>) reached
[2Low F.Thld]	<i>F z R L</i>	Second frequency low threshold ([2 Freq. Threshold] <i>F z d L</i>) reached
[Low I Th.At.]	<i>C t R L</i>	Current low threshold ([Low I Threshold] <i>C t d L</i>) reached
[Pro.Undload]	<i>u L R</i>	Underload warning
[Ovld.P.Alrm]	<i>o L R</i>	Overload warning
[PID high AI.]	<i>P F R H</i>	PID feedback high threshold ([Max fbk Warning] <i>P R H</i>) reached
[PID low AI.]	<i>P F R L</i>	PID feedback low threshold ([Min fbk Warning] <i>P R L</i>) reached
[Regulation Warning]	<i>P , S H</i>	PID regulation unable to reach the set point
[High tq. att.]	<i>t t H R</i>	High torque threshold
[Low tq. att.]	<i>t t L R</i>	Low torque threshold
[Forward]	<i>F r d</i>	Run forward
[Reverse]	<i>R r S</i>	Run reverse
[Th.mot2 att]	<i>t S z</i>	Motor 2 thermal threshold ([Motor2 therm. level] <i>t t d z</i>) reached
[Th.mot3 att]	<i>t S z</i>	Motor 3 thermal threshold ([Motor3 therm. level] <i>t t d z</i>) reached
[Neg Torque]	<i>R t S</i>	Actual torque sign
[Cnfg.0 act.]	<i>C n F 0</i>	Configuration 0 active
[Cnfg.1 act.]	<i>C n F 1</i>	Configuration 1 active
[Cnfg.2 act.]	<i>C n F z</i>	Configuration 2 active
[set 1 active]	<i>C F P 1</i>	Parameter set 1 active
[set 2 active]	<i>C F P z</i>	Parameter set 2 active
[set 3 active]	<i>C F P z</i>	Parameter set 3 active
[LI8]	<i>L , B</i>	Digital input LI8

Setting	Code / Value	Description
[DC Bus Charged]	<i>d b L</i>	DC bus loaded
[In braking]	<i>b r 5</i>	Braking activated
[Power removal state]	<i>P r 0</i>	Power removal state
[Fr.met. alar.]	<i>F 9 L A</i>	Frequency level reached
[Input cont.]	<i>L L C</i>	Line contactor activated
[I present]	<i>0 C P</i>	Motor current present
[Limit sw.att]	<i>L 5 A</i>	Limit switch function activated
[Dynamic Load Warning]	<i>d L d A</i>	Dynamic load warning
[Warning Group 1]	<i>A G 1</i>	Warning group 1
[Warning Group 2]	<i>A G 2</i>	Warning group 2
[Warning Group 3]	<i>A G 3</i>	Warning group 3
[Ext. Error Warning]	<i>E F A</i>	External error warning
[Under V. al.]	<i>u 5 A</i>	Undervoltage warning
[Uvolt warn]	<i>u P A</i>	Undervoltage prevention warning
[Drive Thermal Warning]	<i>t H A</i>	Drive thermal state warning
[Lim T/I att.]	<i>5 5 A</i>	Torque current limitation warning
[ch1 active]	<i>F r 1</i>	Reference channel = channel 1 (for [Freq Switch Assign] <i>r F C</i>)
[ch2 active]	<i>F r 2</i>	Reference channel = channel 2 (for [Freq Switch Assign] <i>r F C</i>)
[ch1 active]	<i>C d 1</i>	Command channel = channel 1 (for [Command Switching] <i>C C 5</i>)
[ch2 active]	<i>C d 2</i>	Command channel = channel 2 (for [Command Switching] <i>C C 5</i>)
[ch1B active]	<i>F r 1 b</i>	Reference channel = channel 1B (for [Freq Switch Assign] <i>r F C</i>)
[Spool end]	<i>E b a</i>	End of bobbin
[Sync wobb]	<i>t 5 Y</i>	Traverse control synchronization counter wobbles
[IGBT al.]	<i>t J A</i>	Thermal junction warning
[LI7]	<i>L , 7</i>	Digital input LI7
[AI3 4-20 Loss Warning]	<i>A P 3</i>	AI3 4-20 mA loss warning
[DC charging]	<i>d C a</i>	DC bus charge option
[F1 key assignment]	<i>F n 1</i>	Function key 1
[F2 key assignment]	<i>F n 2</i>	Function key 2
[F3 key assignment]	<i>F n 3</i>	Function key 3
[F4 key assignment]	<i>F n 4</i>	Function key 4
[Ready]	<i>r d Y</i>	Ready to start
[Yes]	<i>Y E 5</i>	Yes
[DI1]...[DI6]	<i>L , 1...L , 6</i>	Digital input DI1...DI6
[DI11]...[DI16]	<i>L , 11...L , 16</i>	Digital input DI11...DI16 if VW3A3203 I/O extension module has been inserted
[CD00]...[CD10]	<i>C d 00...C d 10</i>	Virtual digital input CMD.0...CMD.10 in [I/O profile] <i>, a</i> configuration
[CD11]...[CD15]	<i>C d 11...C d 15</i>	Virtual digital input CMD.11...CMD.15 regardless of configuration
[C100]...[C110]	<i>C 100...C 110</i>	Virtual digital input CMD1.0...CMD1.10 with integrated Modbus Serial in [I/O profile] <i>, a</i> configuration
[C111]...[C115]	<i>C 111...C 115</i>	Virtual digital input CMD1.11...CMD1.15 with integrated Modbus Serial regardless of configuration

Setting	Code / Value	Description
[C300]...[C310]	C 3 0 0 ... C 3 1 0	Virtual digital input CMD3.0...CMD3.10 with a fieldbus module in [I/O profile] configuration
[C311]...[C315]	C 3 1 1 ... C 3 1 5	Virtual digital input CMD3.11...CMD3.15 with a fieldbus module regardless of configuration
[AI1 4-20 Loss Warning]	R P I	AI1 4-20 mA loss warning

[R1 Delay time] r / d

R1 activation delay time.

The change in state takes effect once the configured time has elapsed when the information becomes true.

The delay cannot be set for the **[Operating State "Fault"] F L E** assignment; and remains at 0.

Setting	Description
0...60,000 ms	Setting range Factory setting: 0 ms

[R1 Active at] r / S

R1 status (output active level).

Setting	Code / Value	Description
1	P 0 S	State 1 when the information is true Factory setting
0	n E G	State 0 when the information is true

Configuration **[1] P 0 S** cannot be modified for the **[Operating State "Fault"] F L E** assignment.

[R1 Holding time] r / H

R1 holding delay time.

The change in state takes effect once the configured time has elapsed when the information becomes false.

The holding time cannot be set for the **[Operating State "Fault"] F L E** assignment, and remains at 0.

Setting	Description
0...9,999 ms	Setting range Factory setting: 0 ms

[R2 configuration] *r 2* - Menu

Access

[Complete settings] → [Input/Output] → [R2 configuration]

About This Menu

Identical to [R1 configuration] *r 1* - Menu (*see page 129*).

[R2 Assignment] *r 2*

R2 assignment.

Factory setting: [Drive Running] *r u n*

[R2 Delay time] *r 2 d*

R2 activation delay time.

[R2 Active at] *r 2 5*

R2 status (output active level).

[R2 Holding time] *r 2 H*

R2 holding delay time.

[R3 configuration] *r 3* - Menu

Access

[Complete settings] → [Input/Output] → [R3 configuration]

About This Menu

Identical to [R1 configuration] *r 1* - Menu (*see page 129*).

[R3 Assignment] *r 3*

R3 assignment.

Factory setting: [Ready] *r d 4*

[R3 Delay time] *r 3 d*

R3 activation delay time.

[R3 Active at] *r 3 5*

R3 status (output active level).

[R3 Holding time] *r 3 H*

R3 holding delay time.

[R4 configuration] *r 4* - Menu

Access

[Complete settings] → [Input/Output] → [R4 configuration]

About This Menu

Identical to [R1 configuration] *r 1* - Menu (*see page 129*).

Following parameters can be accessed if VW3A3204 relay output option module has been inserted.

[R4 Assignment] *r 4* ★

R4 assignment.

[R4 Delay time] *r 4 d* ★

R4 activation delay time.

[R4 Active at] *r 4 5* ★

R4 status (output active level).

[R4 Holding time] *r 4 H* ★

R4 holding delay time.

[R5 configuration] r 5 - Menu

Access

[Complete settings] → [Input/Output] → [R5 configuration]

About This Menu

Identical to [R1 configuration] r 1 - Menu (*see page 129*).

Following parameters can be accessed if VW3A3204 relay output option module has been inserted.

[R5 Assignment] r 5 ★

R5 assignment.

[R5 Delay time] r 5 d ★

R5 activation delay time.

[R5 Active at] r 5 S ★

R5 status (output active level).

[R5 Holding time] r 5 H ★

R5 holding delay time.

[R6 configuration] *r 6* - Menu

Access

[Complete settings] → [Input/Output] → [R6 configuration]

About This Menu

Identical to [R1 configuration] *r 1* - Menu (*see page 129*).

Following parameters can be accessed if VW3A3204 relay output option module has been inserted.

[R6 Assignment] *r 6* ★

R6 assignment.

[R6 Delay time] *r 6 d* ★

R6 activation delay time.

[R6 Active at] *r 6 5* ★

R6 status (output active level).

[R6 Holding time] *r 6 H* ★

R6 holding delay time.

[AQ1 configuration] $R_{\square I}$ - Menu

Access

[Complete settings] → [Input/Output] → [AQ1 configuration]

Configuration of Analog Output

Minimum and maximum values (output values):

The minimum output value, in volts, corresponds to the lower limit of the assigned parameter and the maximum value corresponds to its upper limit. The minimum value may be greater than the maximum value.

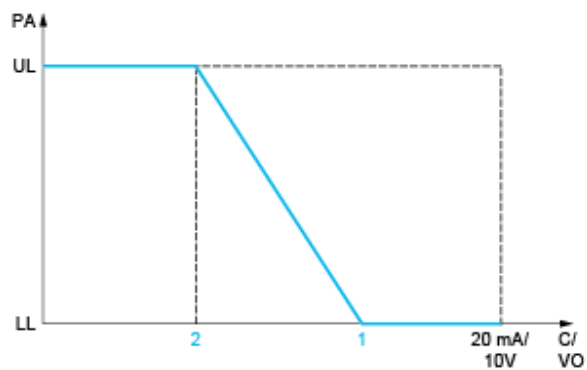
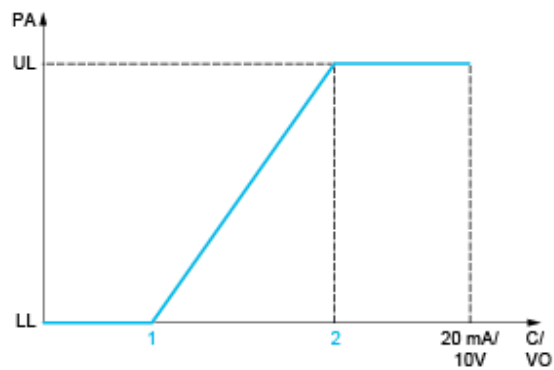

- PA Parameter assigned
 C / VO Current or voltage output
 UL Upper limit
 LL Lower limit
 1 [Min Output] $R_{\square L X}$ or $\mu_{\square L X}$
 2 [Max Output] $R_{\square H X}$ or $\mu_{\square H X}$

Scaling of the Assigned Parameter

The scale of the assigned parameter can be adapted in accordance with the requirements by modifying the values of the lower and upper limits with 2 parameters for each analog output.

These parameters are given in %. 100% corresponds to the total variation range of the configured parameter, so: $100\% = \text{upper limit} - \text{lower limit}$. For example, **[Sign. torque] 5 L 9** which varies between -3 and +3 times the rated torque, 100% corresponds to 6 times the rated torque.

- The **[Scaling AQx min] # 5 L X** parameter modifies the lower limit: $\text{new value} = \text{lower limit} + (\text{range} \times \# 5 L X)$. The value 0% (factory setting) does not modify the lower limit.
- The **[Scaling AQx max] # 5 H X** parameter modifies the upper limit: $\text{new value} = \text{lower limit} + (\text{range} \times \# 5 L X)$. The value 100% (factory setting) does not modify the upper limit.
- **[Scaling AQx min] # 5 L X** must always be lower than **[Scaling AQx max] # 5 H X**.

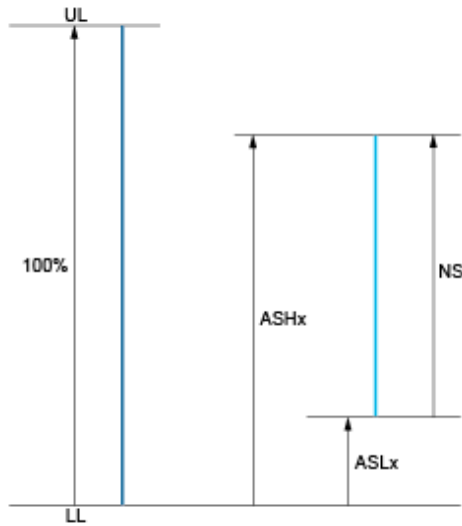

- UL** Upper limit of the assigned parameter
- LL** Lower limit of the assigned parameter
- NS** New scale
- 1 # 5 H X
- 2 # 5 L X

Application Example 2

The value of the motor current at the AO1 output is to be transferred with 0...20 mA, range 2 in motor, In motor being the equivalent of a 0.8 In drive.

- The **[I motor] # 5 L 1** parameter varies from 0 to 2 times the rated drive current, or a range of 2.5 times the rated drive current.
- **[Scaling AQ1 min] # 5 L 1** must not modify the lower limit, which therefore remains at its factory setting of 0%.
- **[Scaling AQ1 max] # 5 H 1** must modify the upper limit by 0.5x the rated motor torque, or $100 - 100/5 = 80\%$ ($\text{new value} = \text{lower limit} + (\text{range} \times \text{[Scaling AQ1 max] # 5 H 1})$).

[AQ1 assignment] $R_{\alpha I}$

AO1 assignment.

Setting	Code / Value	Description
[Not Configured]	n_{α}	Not assigned
[Motor Current]	αC_r	Current in the motor, from 0 to 2 In (In = rated drive current indicated in the installation manual and on the drive nameplate)
[Motor freq.]	αF_r	Output frequency, from 0 to [Max frequency] ϵF_r
[Ramp out.]	$\alpha r P$	From 0 to [Max frequency] ϵF_r
[Motor torq.]	$\epsilon r q$	Motor torque, from 0 to 3 times the rated motor torque
[Sign. torque]	$5 \epsilon q$	Signed motor torque, between -3 and +3 times the rated motor torque. The + sign corresponds to the motor mode and the - sign to the generator mode (braking).
[sign ramp]	$\alpha r 5$	Signed ramp output, between -[Max frequency] ϵF_r and +[Max frequency] ϵF_r
[PID ref.]	$\alpha P 5$	PID regulator reference between [Min PID reference] $P, P 1$ and [Max PID reference] $P, P 2$
[PID feebk]	$\alpha P F$	PID regulator feedback between [Min PID feedback] $P, F 1$ and [Max PID feedback] $P, F 2$
[PID error]	$\alpha P E$	PID regulator error between -5% and +5% of [Max PID feedback] $P, F 2$ - [Min PID feedback] $P, F 1$
[PID output]	$\alpha P, i$	PID regulator output between [Low speed] $L 5 P$ and [High speed] $H 5 P$
[Drive power]	$\alpha P r$	Motor power, between 0 and 2.5 times [Nominal Motor Power] $n P r$
[Mot thermal]	$\epsilon H r$	Motor thermal state, from 0 to 200% of the rated thermal state
[Drv thermal]	$\epsilon H d$	Drive thermal state, from 0 to 200% of the rated thermal state
[Sig. o/p frq.]	$\alpha F 5$	Signed output frequency, between -[Max frequency] ϵF_r and +[Max frequency] ϵF_r
[Motor volt.]	$u_{\alpha P}$	Voltage applied to the motor, between 0 and [Nom Motor Voltage] $u_{n 5}$ warning

[AQ1 Type] $R_{\alpha I \epsilon}$

AO1 type.

Setting	Code / Value	Description
[Voltage]	$I D u$	0-10 Vdc Factory setting
[Current]	$D R$	0-20 mA

[AQ1 min output] $R_{\alpha L I \star}$

AO1 current scaling parameter of 0%.

This parameter can be accessed if [AQ1 Type] $R_{\alpha I \epsilon}$ is set to [Current] $D R$.

Setting	Description
0.0...20.0 mA	Setting range Factory setting: 4.0 mA

[AQ1 max output] $R_{\alpha H I \star}$

AO1 current scaling parameter of 100%.

This parameter can be accessed if [AQ1 Type] $R_{\alpha I \epsilon}$ is set to [Current] $D R$.

Setting	Description
0.0...20.0 mA	Setting range Factory setting: 20.0 mA

[AQ1 min Output] μ OL I★

AO1 voltage scaling parameter of 0%.

This parameter can be accessed if **[AQ1 Type] R IL** is set to **[Voltage] I OL**.

Setting	Description
0.0...10.0 V	Setting range Factory setting: 0.0 V

[AQ1 max Output] μ OH I★

AO1 voltage scaling parameter of 100%.

This parameter can be accessed if **[AQ1 Type] R IL** is set to **[Voltage] I OL**.

Setting	Description
0.0...10.0 V	Setting range Factory setting: 10.0 V

[Scaling AQ1 min] R SL I

AO1 scaling parameter of 0%.

Scaling of the lower limit of the assigned parameter, as a % of the maximum possible variation.

Setting	Description
0... [Scaling AQ1 max] RSH I %	Setting range Factory setting: 0%

[Scaling AQ1 max] R SH I

AO1 scaling parameter of 100%.

Scaling of the upper limit of the assigned parameter, as a % of the maximum possible variation.

Setting	Description
[Scaling AQ1 min] RSL I ...100.0%	Setting range Factory setting: 100.0%

[AQ1 Filter] R IF

AO1 cutoff time of the low-filter.

Setting	Description
0.00...10.00 s	Setting range Factory setting: 0.00 s

[AQ2 configuration] $R \square \square$ - Menu**Access**

[Complete settings] → [Input/Output] → [AQ2 configuration]

[AQ2 assignment] $R \square \square$

AO2 assignment.

Identical to **[AQ1 assignment] $R \square I$** (see page 139).

[AQ2 Type] $R \square \square \square$

AO2 type.

Setting	Code / Value	Description
[Voltage]	$I \square \square$	0-10 Vdc
[Current]	$\square R$	0-20 mA Factory setting
[PTC Management]	$P \square \square$	1 to 6 PTC (in serial)
[KTY]	$K \square \square$	1 KTY84
[PT1000]	$I P \square \square$	1 PT1000 connected with 2 wires
[PT100]	$I P \square \square$	1 PT100 connected with 2 wires
[Water Prob]	$L E \square \square \square$	Water level
[3PT1000]	$\square P \square \square$	3 PT1000 connected with 2 wires
[3PT100]	$\square P \square \square$	3 PT100 connected with 2 wires

[AQ2 min output] $R \square L \square \star$

AO2 current scaling parameter of 0%.

This parameter can be accessed if **[AQ2 Type] $R \square \square \square$** is set to **[Current] $\square R$** .

Identical to **[AQ1 min output] $R \square L I$** (see page 139).

[AQ2 max output] $R \square H \square \star$

AO2 current scaling parameter of 100%.

This parameter can be accessed if **[AQ2 Type] $R \square \square \square$** is set to **[Current] $\square R$** .

Identical to **[AQ1 max output] $R \square H I$** (see page 139).

[AQ2 min Output] $\square \square L \square \star$

AO2 voltage scaling parameter of 0%.

This parameter can be accessed if **[AQ2 Type] $R \square \square \square$** is set to **[Voltage] $I \square \square$** .

Identical to **[AQ1 min Output] $\square \square L I$** (see page 140).

[AQ2 max Output] $\square \square H \square \star$

AO2 voltage scaling parameter of 100%.

This parameter can be accessed if **[AQ2 Type] $R \square \square \square$** is set to **[Voltage] $I \square \square$** .

Identical to **[AQ1 max Output] $\square \square H I$** (see page 140).

[Scaling AQ2 min] $R \square L \square$

AQ2 scaling parameter of 0%.

Identical to **[Scaling AQ1 min] $R \square L I$** (see page 140).

[Scaling AQ2 max] $R \square H \square$

AO2 scaling parameter of 100%.

Identical to **[Scaling AQ1 max] $R \square H I$** (see page 140).

[AQ2 Filter] $R \square \square F$

AO2 cutoff time of the low-filter.

Identical to **[AQ1 Filter] $R \square I F$** (see page 140).

Section 6.3

[Command and Reference]

[Command and Reference] *C r P* - Menu

Access

[Complete settings] → [Command and Reference]

Command and Reference Channels Parameter can be Accessed

Run commands (forward, reverse, stop, and so on) and references can be sent using the following channels:

Command	Reference
Terminals: Digital inputs DI	Terminals: Analog inputs AI, pulse input
Plain Text Display Terminal	Plain Text Display Terminal
Integrated Modbus	Integrated Modbus
Fieldbus module	Fieldbus module
–	+/- speed via the Plain Text Display Terminal

NOTE: The stop keys on the Plain Text Display Terminal can be programmed as non-priority keys. A stop key can only have priority if the **[Stop Key Enable] *P 5 t*** parameter menu is set to **[Yes] *Y E 5***.

The behavior of the drive can be adapted according to requirements:

- **[Not separ.] *S , P***: Command and reference are sent via the same channel.
- **[Separate] *S E P***: Command and reference may be sent via different channels. In these configurations, control via the communication bus is performed in accordance with the DRIVECOM standard with only 5 freely assignable bits (see communication parameters manual). The application functions cannot be accessed via the communication interface.
- **[I/O profile] *i o***: The command and the reference can come from different channels. This configuration both simplify and extends use via the communication interface. Commands may be sent via the digital inputs on the terminals or via the communication bus. When commands are sent via a bus, they are available on a word, which acts as virtual terminals containing only digital inputs. Application functions can be assigned to the bits in this word. More than one function can be assigned to the same bit.

NOTE: Stop commands from the Plain Text Display Terminal remain active even if the terminals are not the active command channel.

Reference Channel for [Not separ.] 5, n, [Separate] SEP and [I/O profile] io Configurations, PID Not Configured

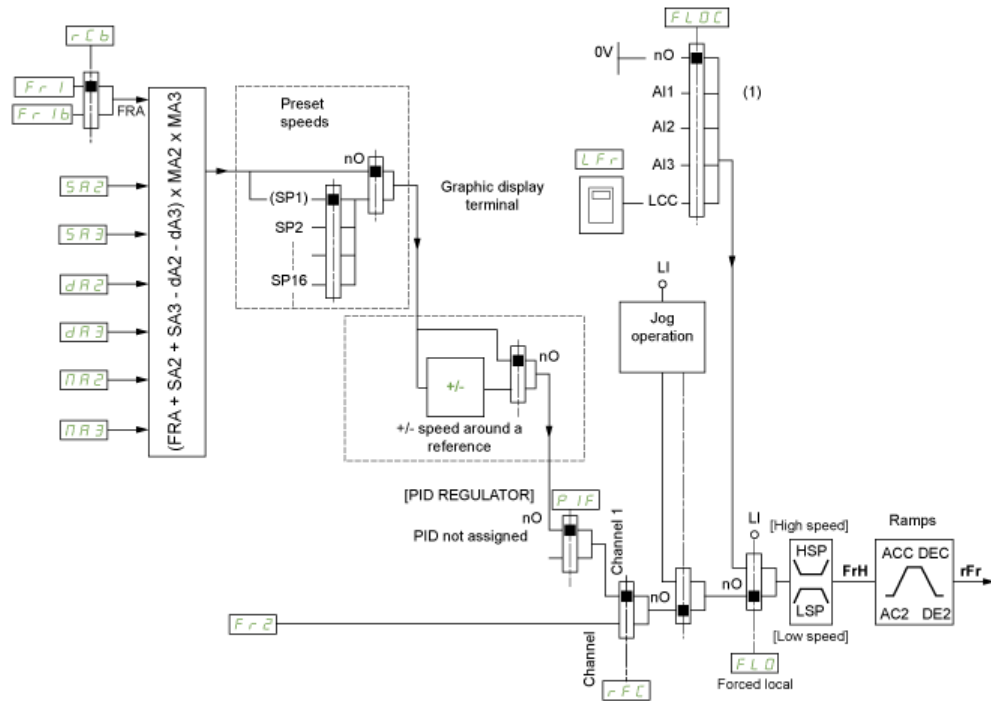

(1) Note: Forced local is not active in [I/O].

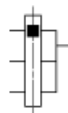

The black square represents the factory setting assignment.

Fr 1, SA2, SA3, dA2, dA3, nA2, nA3: Plain Text Display Terminal, integrated Modbus serial, and fieldbus module.

Fr 1b, for SEP and io: Plain Text Display Terminal, integrated Modbus, and fieldbus module.

Fr 1b, for 5, n: Plain Text Display Terminal, only accessible if Fr 1 = terminals.

Fr 2: Plain Text Display Terminal, integrated Modbus serial, +/- speed, and fieldbus module.

Reference Channel for [Not separ.] 5, 11, [Separate] SEP and [I/O profile] 10 Configurations, PID Configured with PID References at the Terminals

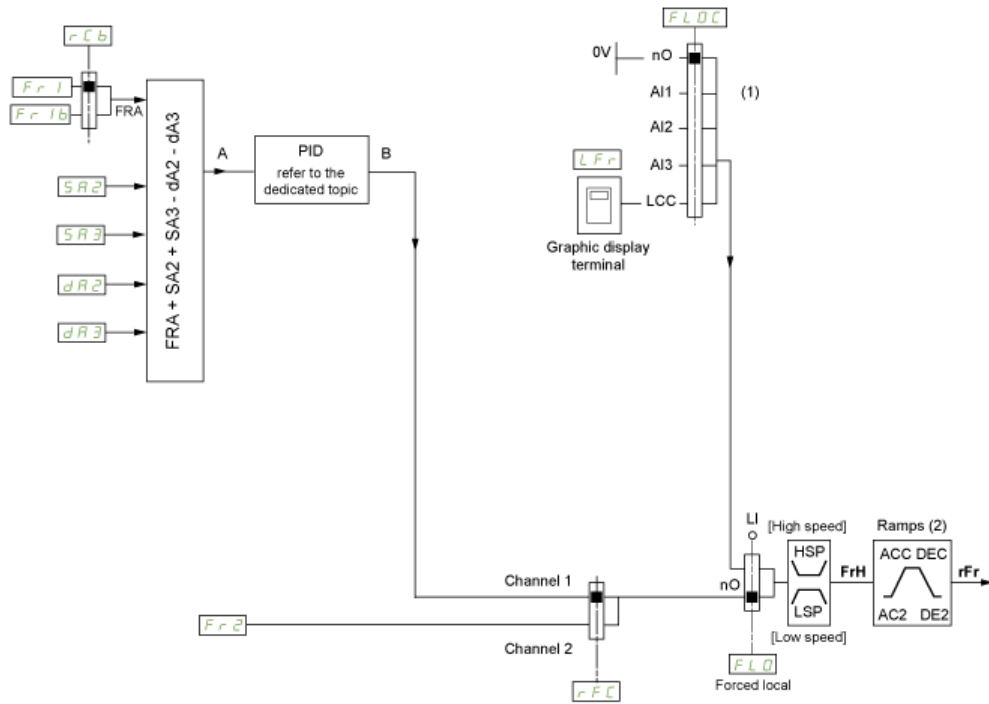

- (1) **Note:** Forced local is not active in [I/O profile].
- (2) Ramps not active if the PID function is active in automatic mode.

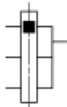

The black square represents the factory setting assignment.

- Fr 1: Plain Text Display Terminal, integrated Modbus, and fieldbus module.
- Fr 1b, for SEP and 10: Plain Text Display Terminal, integrated Modbus serial, and fieldbus module.
- Fr 1b, for 5, 11: Plain Text Display Terminal, only accessible if Fr 1 = terminals.
- SA2, SA3, dRA2, dRA3: Plain Text Display Terminal only.
- Fr 2: Plain Text Display Terminal, integrated Modbus serial, +/- speed, and fieldbus module.

[Low Speed] LSP

Motor frequency at low speed.

Setting ()	Description
0...500 Hz	Setting range Factory setting: 0 Hz

[High Speed] HSP

Motor frequency at high speed.

Setting ()	Description
0...500 Hz	Setting range Factory setting: 500 Hz

[Ref Freq 1 Config] *F r 1*

Configuration reference frequency 1.

Setting	Code / Value	Description
[AI1]	<i>R , 1</i>	Analog input AI1 Factory setting
[AI2]...[AI3]	<i>R , 2...R , 3</i>	Analog input AI2...AI3
[AI4]...[AI5]	<i>R , 4...R , 5</i>	Analog input AI4...AI5 if VW3A3203 I/O extension module has been inserted
[Ref.Freq-Rmt.Term]	<i>L C C</i>	Display terminal source
[Ref. Freq-Modbus]	<i>Π d b</i>	Reference frequency via Modbus
[Ref. Freq-Com. Module]	<i>n E L</i>	Reference frequency via Com Module

[Reverse Disable] *r , n*

Reverse directions disable.

Lock of movement in reverse direction does not apply to direction requests sent by digital inputs.

Reverse direction requests sent by digital inputs are taken into account.

Reverse direction requests sent by the Plain Text Display Terminal or sent by the line are not taken into account.

Any reverse speed reference originating from the PID, summing input, and so on, is interpreted as a zero reference (0 Hz).

Setting	Code / Value	Description
[No]	<i>n o</i>	No
[Yes]	<i>Y E S</i>	Yes Factory Setting

[Control Mode] *C H C F* 

Mixed mode configuration.

 WARNING**UNANTICIPATED EQUIPMENT OPERATION**

Disabling **[I/O profile] *i o*** resets the drive to the factory settings.

- Verify that restoring the factory settings is compatible with the type of wiring used.

Failure to follow these instructions can result in death, serious injury, or equipment damage.

Setting	Code / Value	Description
[Not separ.]	<i>S , n</i>	Reference and command, not separate Factory Setting
[Separate]	<i>S E P</i>	Separate reference and command. This assignment cannot be accessed in [I/O profile] <i>i o</i> .
[I/O profile]	<i>i o</i>	I/O profile

[Command Switching] C C 5 ★

Control channel switch.

This parameter can be accessed if **[Control Mode] C H C F** is set to **[Separate] S E P** or to **[I/O profile] I O**.

If the assigned input or bit is at 0, channel **[Cmd channel 1] C d 1** is active. If the assigned input or bit is at 1, channel **[Cmd channel 2] C d 2** is active.

⚠ WARNING
UNANTICIPATED EQUIPMENT OPERATION
<p>This parameter can cause unintended movements, for example an inversion of the direction of the rotation of the motor, a sudden acceleration or a stop.</p> <ul style="list-style-type: none"> ● Verify that the setting of this parameter does not cause unintended movements. ● Verify that the setting of this parameter does not result in unsafe conditions. <p>Failure to follow these instructions can result in death, serious injury, or equipment damage.</p>

Setting	Code / Value	Description
[Command channel 1]	<i>C d 1</i>	Command channel = channel 1 (for CCS) Factory setting
[Command channel 2]	<i>C d 2</i>	Command channel = channel 2 (for CCS)
[DI1]...[DI6]	<i>L , I ... L , 6</i>	Digital input DI1...DI6
[DI11]...[DI16]	<i>L , I I ... L , 16</i>	Digital input DI11...DI16 if VW3A3203 I/O extension module has been inserted
[C101]...[C110]	<i>C 1 0 0 ... C 1 1 0</i>	Virtual digital input CMD1.01...CMD1.10 with integrated Modbus Serial in [I/O profile] I O configuration
[C111]...[C115]	<i>C 1 1 1 ... C 1 1 5</i>	Virtual digital input CMD1.11...CMD1.15 with integrated Modbus Serial regardless of configuration
[C300]...[C310]	<i>C 3 0 0 ... C 3 1 0</i>	Virtual digital input CMD3.0...CMD3.10 with a fieldbus module in [I/O profile] I O configuration
[C311]...[C315]	<i>C 3 1 1 ... C 3 1 5</i>	Virtual digital input CMD3.11...CMD3.15 with a fieldbus module regardless of configuration

[Cmd channel 1] C d 1 ★

Control ch.1 configuration.

This parameter can be accessed if **[Control Mode] C H C F** is set to **[Separate] S E P** or **[I/O profile] I O**.

Setting	Code / Value	Description
[Terminals]	<i>t E r</i>	Terminals Factory Setting
[Ref.Freq-Rmt.Term]	<i>L C C</i>	Display terminal source
[Ref. Freq-Modbus]	<i>n d b</i>	Reference frequency via Modbus
[Ref. Freq-Com. Module]	<i>n E t</i>	Reference frequency via Com Module

[Cmd channel 2] C d 2 ★

Command channel 2 assignment.

This parameter can be accessed if **[Control Mode] C H C F** is set to **[Separate] S E P** or **[I/O profile] I O**.

Identical to **[Cmd channel 1] C d 1**.

[Freq Switch Assign] $F r C$ **⚠ WARNING****UNANTICIPATED EQUIPMENT OPERATION**

This parameter can cause unintended movements, for example an inversion of the direction of the rotation of the motor, a sudden acceleration or a stop.

- Verify that the setting of this parameter does not cause unintended movements.
- Verify that the setting of this parameter does not result in unsafe conditions.

Failure to follow these instructions can result in death, serious injury, or equipment damage.

Frequency switching assignment.

If the assigned input or bit is at 0, channel **[Ref Freq Channel 1] $F r 1$** is active.

If the assigned input or bit is at 1, channel **[Ref Freq Channel 2] $F r 2$** is active.

Setting	Code / Value	Description
[Ref Freq Channel 1]	$F r 1$	Reference channel = channel 1 (for RFC)
[Ref Freq Channel 2]	$F r 2$	Reference channel = channel 2 (for RFC)
[DI1]...[DI6]	$L 1 \dots L 6$	Digital input DI1...DI6
[DI11]...[DI16]	$L 11 \dots L 16$	Digital input DI11...DI16 if VW3A3203 I/O extension module has been inserted
[C101]...[C110]	$C 101 \dots C 110$	Virtual digital input CMD1.01...CMD1.10 with integrated Modbus Serial in [I/O profile] , 0 configuration
[C111]...[C115]	$C 111 \dots C 115$	Virtual digital input CMD1.11...CMD1.15 with integrated Modbus Serial regardless of configuration
[C300]...[C310]	$C 300 \dots C 310$	Virtual digital input CMD3.0...CMD3.10 with a fieldbus module in [I/O profile] , 0 configuration
[C311]...[C315]	$C 311 \dots C 315$	Virtual digital input CMD3.11...CMD3.15 with a fieldbus module regardless of configuration
[DI1 (Low level)]...[DI6 (Low level)]	$L 1L \dots L 6L$	Digital input DI1...DI6 used at low level
[DI11 (Low level)]...[DI16 (Low level)]	$L 11L \dots L 16L$	Digital input DI11...DI16 used at low level if VW3A3203 I/O extension module has been inserted

[Ref Freq 2 Config] $F r 2$

Configuration reference frequency 2.

Setting	Code / Value	Description
[Not Configured]	$n o$	Not assigned. If [Control Mode] $C H C F$ is set to [Not separ.] $5 , 11$, the command is at the terminals with a zero reference. If [Control Mode] $C H C F$ is set to [Separate] $5 E P$ or [I/O profile] , 0 , the reference is zero. Factory Setting
[AI1]...[AI3]	$A 1 \dots A 3$	Analog input AI1...AI3
[AI4]...[AI5]	$A 4 \dots A 5$	Analog input AI4...AI5 if VW3A3203 I/O extension module has been inserted
[Ref Frequency via DI]	$u P d E$	+/- speed command
[Ref.Freq-Rmt.Term]	$L C C$	Display terminal source
[Ref. Freq-Modbus]	$11 d b$	Reference frequency via Modbus
[Ref. Freq-Com. Module]	$n E E$	Reference frequency via Com Module
[PulseInput Assignment On DI5]...[PulseInput Assignment On DI6]	$P 5 \dots P 6$	Digital input DI5...DI6 used as pulse input

[Copy Ch1-Ch2] C o P 

Copy channel 1 reference frequency to channel 2.

⚠ WARNING
UNANTICIPATED EQUIPMENT OPERATION
<p>This parameter can cause unintended movements, for example an inversion of the direction of the rotation of the motor, a sudden acceleration or a stop.</p> <ul style="list-style-type: none"> • Verify that the setting of this parameter does not cause unintended movements. • Verify that the setting of this parameter does not result in unsafe conditions. <p>Failure to follow these instructions can result in death, serious injury, or equipment damage.</p>

Can be used to copy the current reference and/or the command with switching in order to avoid speed surges, for example.

If **[Control Mode] C H C F** (see page 145) is set to **[Not separ.] S , Π** or **[Separate] S E P**, copying is possible only from channel 1 to channel 2.

If **[Control Mode] C H C F** is set to **[I/O profile] , o**, copying is possible in both directions. A reference or a command cannot be copied to a channel on the terminals. The reference copied is **[Pre-Ramp Ref Freq] F r H** (before ramp) unless the destination channel reference is set via +/- speed. In this case, the reference copied is **[Output frequency] r F r** (after ramp).

Setting	Code / Value	Description
[No]	n o	No copy Factory Setting
[Reference Frequency]	S P	Copy reference
[Command]	C d	Copy command
[Cmd + Ref Frequency]	R L L	Copy reference and command

As the Plain Text Display Terminal may be selected as the command and/or reference channel, its action modes can be configured.

Comments:

- The Plain Text Display Terminal command/reference is only active if the command and/or reference channels from the terminal are active except for **[T/K] F E** (command via the Plain Text Display Terminal), which takes priority over these channels. Press **[T/K] F E** (command via the Plain Text Display Terminal) again to revert control to the selected channel.
- Command and reference via the Plain Text Display Terminal are impossible if the latter is connected to more than one drive.
- The preset PID reference functions can only be accessed if **[Control Mode] C H C F** is set to **[Not separ.] S , Π** or **[Separate] S E P**.
- The command via the Plain Text Display Terminal can be accessed regardless of the **[Control Mode] C H C F**.

[Forced Local Freq] F L o C

Forced local reference source assignment.

Setting	Code / Value	Description
[Not Configured]	n o	Not assigned (control via the terminals with zero reference) Factory Setting
[AI1]...[AI3]	R , 1...R , 3	Analog input AI1...AI3
[AI4]...[AI5]	R , 4...R , 5	Analog input AI4...AI5 if VW3A3203 I/O extension module has been inserted
[Ref.Freq-Rmt.Term]	L C C	Display terminal source
[PulseInput Assignment On DI5]...[PulseInput Assignment On DI6]	P , 5...P , 6	Digital input DI5...DI6 used as pulse input

[Time-out Forc. Local] *FLot* ★

Time for channel confirmation after forced local.

This parameter can be accessed if **[Forced Local Assign] *FLa*** is not set to **[No] *no***.

Setting 	Description
0.1...30.0 s	Setting range Factory setting: 10.0 s

[Forced Local Assign] *FLa*

Forced local assignment.

Forced local mode is active when the input is at state 1.

[Forced Local Assign] *FLa* is forced to **[No] *no*** if **[Control Mode] *CHCF*** is set to **[I/O profile] *io***

Setting	Code / Value	Description
[Not Assigned]	<i>no</i>	Not assigned Factory setting
[DI1]...[DI6]	<i>L, I...L, IB</i>	Digital input DI1...DI6
[DI11]...[DI16]	<i>L, I, I...L, IB</i>	Digital input DI11...DI16 if VW3A3203 I/O extension module has been inserted

[Stop Key Enable] *PSE* 

Stop key enable.

⚠ WARNING**LOSS OF CONTROL**

This function disables the Stop key of the Display Terminal if the setting of the parameter **[Command Channel] *CCdC*** is not ***HP, I***.

Only set this parameter to *no* if you have implemented appropriate alternative stop functions.

Failure to follow these instructions can result in death, serious injury, or equipment damage.

This is a freewheel stop. If the active command channel is the Plain Text Display Terminal, the stop is performed according to the **[Type of stop] *SEt*** irrespective of the configuration of **[Stop Key Enable] *PSE***.

Setting	Code / Value	Description
[No]	<i>no</i>	–
[Yes]	<i>YES</i>	Gives priority to the STOP key on the Plain Text Display Terminal when the Plain Text Display Terminal is not enabled as the command channel. Factory Setting

Section 6.4

[Generic functions] - [Ramp]

[Ramp] *r A P P* - Menu

Access

[Complete settings] → [Generic functions] → [Ramp]

[Ramp Type] *r P t*

Type of ramp.

Setting	Code / Value	Description
[Linear]	<i>L i n</i>	Linear ramp Factory setting
[S-Ramp]	<i>S</i>	S ramp
[U-Ramp]	<i>u</i>	U ramp
[Customized]	<i>C u s</i>	Customer ramp

[Ramp increment] *i n c*

This parameter is valid for [Acceleration] *A C C*, [Deceleration] *d E C*, [Acceleration 2] *A C 2* and [Deceleration 2] *d E 2*.

This table presents the parameter settings:

Setting ()	Code / Value	Description
[0.01]	<i>0.0 1</i>	Ramp up to 99.99 seconds
[0.1]	<i>0. 1</i>	Ramp up to 999.9 seconds Factory setting
[1]	<i>1</i>	Ramp up to 6,000 seconds

[Acceleration] *A C C*

Time to accelerate from 0 to the [Rated Motor Freq] *F r 5*.

To have repeatability in ramps, the value of this parameter must be set according to the possibility of the application.

Setting ()	Description
0.00...6,000.00 s ⁽¹⁾	Setting range Factory setting: 30.0 s
(1) Range 0.01 to 99.99 s or 0.1 to 999.9 s or 1 to 6,000 according to [Ramp increment] <i>i n c</i>	

[Deceleration] *d E C*

Time to decelerate from the [Rated Motor Freq] *F r 5* to 0.

To have repeatability in ramps, the value of this parameter must be set according to the possibility of the application.

Setting ()	Description
0.00...6,000.00 s ⁽¹⁾	Setting range Factory setting: 30.0 s
(1) Range 0.01 to 99.99 s or 0.1 to 999.9 s or 1 to 6,000 according to [Ramp increment] <i>i n c</i>	

[Begin Acc round] E R 1 ★

Rounding of start of acceleration ramp as a % of the **[Acceleration] A C C** or **[Acceleration 2] A C 2** ramp time.

Can be set from 0 to 100%.

This parameter can be accessed if the **[Ramp type] r P t** is set to **[Customized] C u S** .

Setting ()	Description
0...100%	Setting range Factory setting: 10%

[End Acc round] E R 2 ★

Rounding of end of acceleration ramp as a % of the **[Acceleration] A C C** or **[Acceleration 2] A C 2** ramp time.

Can be set between 0 and (100% - **[Begin Acc round] E R 1**).

This parameter can be accessed if the **[Ramp type] r P t** is set to **[Customized] C u S** .

Setting ()	Description
0...100%	Setting range Factory setting: 10%

[Begin Dec round] E R 3 ★

Rounding of start of deceleration ramp as a % of the **[Deceleration] d E C** or **[Deceleration 2] d E 2** ramp time.

Can be set from 0 to 100%.

This parameter can be accessed if the **[Ramp type] r P t** is set to **[Customized] C u S** .

Setting ()	Description
0...100%	Setting range Factory setting: 10%

[End Dec round] E R 4 ★

Rounding of end of deceleration ramp as a % of the **[Deceleration] d E C** or **[Deceleration 2] d E 2** ramp time.

Can be set between 0 and (100% - **[Begin Dec round] E R 3**).

This parameter can be accessed if the **[Ramp type] r P t** is **[Customized] C u S** .

Setting ()	Description
0...100%	Setting range Factory setting: 10%

[SwitchRamp2] F r t

Ramp switching threshold

The second ramp is switched if the value of **[SwitchRamp2] F r t** is not 0 (0 deactivates the function) and the output frequency is greater than **[SwitchRamp2] F r t** .

Threshold ramp switching can be combined with **[Ramp switch ass.] r P 5** switching as follows:

DI or Bit	Frequency	Ramp
0	< Frt	ACC, dEC
0	> Frt	ACC, dE2
1	< Frt	ACC, dE2
1	> Frt	ACC, dE2

Setting ()	Description
0.0...500.0 Hz	Setting range Factory setting: 0.0 Hz

[Ramp switch ass.] *r P 5*

Ramp switching.

Setting	Code / Value	Description
[Not Assigned]	<i>n a</i>	Not assigned Factory setting
[DI1]...[DI6]	<i>L 1 1...L 1 6</i>	Digital input DI1...DI6
[DI11]...[DI16]	<i>L 1 1 1...L 1 1 6</i>	Digital input DI11...DI16 if VW3A3203 I/O extension module has been inserted
[CD00]...[CD10]	<i>C d 0 0...C d 1 0</i>	Virtual digital input CMD.0...CMD.10 in [I/O profile] <i>i a</i> configuration
[CD11]...[CD15]	<i>C d 1 1...C d 1 5</i>	Virtual digital input CMD.11...CMD.15 regardless of configuration
[C100]...[C110]	<i>C 1 0 0...C 1 1 0</i>	Virtual digital input CMD1.0...CMD1.10 with integrated Modbus Serial in [I/O profile] <i>i a</i> configuration
[C111]...[C115]	<i>C 1 1 1...C 1 1 5</i>	Virtual digital input CMD1.11...CMD1.15 with integrated Modbus Serial regardless of configuration
[C300]...[C310]	<i>C 3 0 0...C 3 1 0</i>	Virtual digital input CMD3.0...CMD3.10 with a fieldbus module in [I/O profile] <i>i a</i> configuration
[C311]...[C315]	<i>C 3 1 1...C 3 1 5</i>	Virtual digital input CMD3.11...CMD3.15 with a fieldbus module regardless of configuration

[Acceleration 2] *A C 2* ★

Time to accelerate from 0 to the **[Rated motor freq.]** *F r 5*. To have repeatability in ramps, the value of this parameter must be set according to the possibility of the application.

This parameter can be accessed if **[SwitchRamp2]** *F r 4* is greater than 0 or if **[Ramp switch ass.]** *r P 5* is assigned.

Setting ()	Description
0.0...6,000 s ⁽¹⁾	Setting range Factory setting: 5.0 s
(1) Range 0.01 to 99.99 s or 0.1 to 999.9 s or 1...6,000 s according to [Ramp increment] <i>i n r</i> .	

[Deceleration 2] *d E 2* ★

Time to decelerate from the **[Rated motor freq.]** *F r 5* to 0. To have repeatability in ramps, the value of this parameter must be set according to the possibility of the application.

This parameter can be accessed if **[SwitchRamp2]** *F r 4* is greater than 0 or if **[Ramp switch ass.]** *r P 5* is assigned.

Setting ()	Description
0.0...6,000 s ⁽¹⁾	Setting range Factory setting: 5.0 s
(1) Range 0.01 to 99.99 s or 0.1 to 999.9 s or 1...6,000 s according to [Ramp increment] <i>i n r</i> .	

[Dec.Ramp Adapt] brA

Deceleration ramp adaptation.

NOTICE**DAMAGE TO THE MOTOR**

Only set this parameter to **YES** or **no** if the connected motor is a permanent magnet synchronous motor. Other settings demagnetize permanent magnet synchronous motors.

Failure to follow these instructions can result in equipment damage.

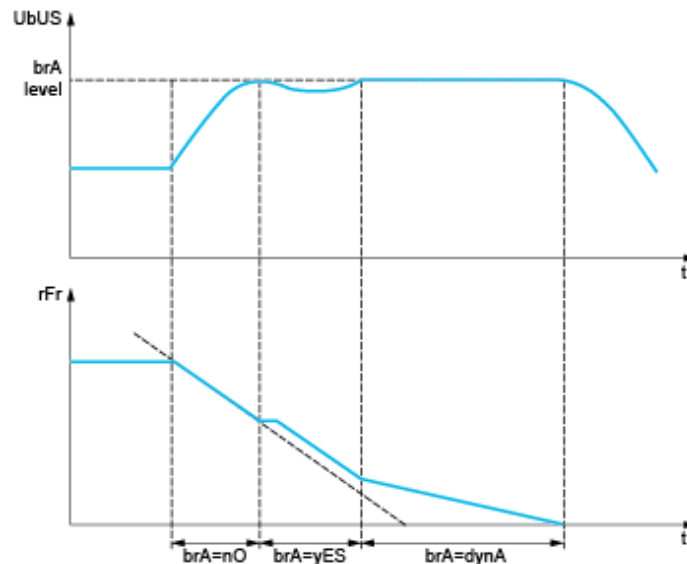

Activating this function automatically adapts the deceleration ramp, if this has been set at a too low value according to the inertia of the load, which can cause an overvoltage detected error.

The function is incompatible with applications requiring:

- Positioning on a ramp
- The use of a braking resistor (the resistor would not operate correctly).

Setting	Code / Value	Description
[No]	no	Function inactive
[Yes]	YES	Function active, for applications that do not require strong deceleration Factory setting
[High torq. A]	dynA	Addition of a constant current flow component. The [High torq. A] dynA selection appears depending on the rating of the drive and [Motor control type] LLE. It enables stronger deceleration to be obtained than with [Yes] YES. Use comparative testing to determine your selection When [Dec.Ramp Adapt] brA is configured on [High torq. x] dynX, the dynamic performances for braking are improved by the addition of a current flow component. The aim is to increase the iron loss and magnetic energy stored in the motor.

Section 6.5

[Generic functions] - [Stop configuration]

[Stop configuration] 5 5 5 - Menu

Access

[Complete settings] → [Generic functions] → [Stop configuration]

About This Menu

NOTE: Some types of stops cannot be used with all other functions. Follow the instructions

[Type of stop] 5 5 5

Normal stop mode.

Stop mode on disappearance of the run command or appearance of a stop command.

NOTE: If [Low speed time out] 5 5 5 is not 0, only ramp type stops may be configured.

Setting	Code / Value	Description
[On Ramp]	r P P	Stop on ramp Factory setting
[Fast stop]	F 5 5	Fast stop
[Freewheel]	n 5 5	Freewheel stop
[DC injection]	d C ,	DC injection stop. Available only if [Motor control type] C 5 5 is not set to [SYN_U VC] 5 4 n u.

[Freewheel stop ass.] n 5 5

Freewheel stop.

The stop is activated when the input or the bit changes to 0. If the input returns to state 1 and the run command is still active, the motor will only restart if [2/3-wire control] 5 C C is set to [2-Wire Control] 2 C and if [2-wire type] 5 C 5 is set to [Level] L E L or [Fwd priority] P F 0. If not, a new run command must be sent.

Setting	Code / Value	Description
[Not Assigned]	n 0	Not assigned Factory setting
[DI1]...[DI6]	L , I...L , 5	Digital input DI1...DI6
[DI11]...[DI16]	L , I I...L , 1 5	Digital input DI11...DI16 if VW3A3203 I/O extension module has been inserted
[CD00]...[CD10]	C d 0 0...C d 1 0	Virtual digital input CMD.0...CMD.10 in [I/O profile] , 0 configuration
[CD11]...[CD15]	C d 1 1...C d 1 5	Virtual digital input CMD.11...CMD.15 regardless of configuration
[C100]...[C110]	C 1 0 0...C 1 1 0	Virtual digital input CMD1.0...CMD1.10 with integrated Modbus Serial in [I/O profile] , 0 configuration
[C111]...[C115]	C 1 1 1...C 1 1 5	Virtual digital input CMD1.11...CMD1.15 with integrated Modbus Serial regardless of configuration
[C300]...[C310]	C 3 0 0...C 3 1 0	Virtual digital input CMD3.0...CMD3.10 with a fieldbus module in [I/O profile] , 0 configuration
[C311]...[C315]	C 3 1 1...C 3 1 5	Virtual digital input CMD3.11...CMD3.15 with a fieldbus module regardless of configuration

[Freewheel stop Thd] FFL ★

Freewheel stop threshold.

Speed threshold below which the motor will switch to freewheel stop.

This parameter supports switching from a ramp stop or a fast stop to a freewheel stop below a low speed threshold.

This parameter can be accessed if:

- **[Type of stop] SLE** is set to **[Fast stop] FSE** or **[Ramp stop] rPP**, and
- **[Auto DC Injection] ADC** is configured.

Setting ()	Description
0.2...500.0 Hz	Setting range Factory setting: 0.2 Hz

[Fast stop ass.] FSE

Fast stop.

The stop is activated when the input changes to 0 or the bit changes to 1 (bit in **[I/O profile] io** at 0).

If the input returns to state 1 and the run command is still active, the motor will only restart if **[2/3-wire control] ECC** is set to **[2-Wire Control] 2C** and if **[2-wire type] ECE** is set to **[Level] LEL** or **[Fwd priority] PFO**.

If not, a new run command must be sent.

NOTE: This function cannot be used with some other functions. Follow the instructions about the compatibility of functions.

Setting	Code / Value	Description
[Not Assigned]	<i>no</i>	Not assigned Factory setting
[DI1]...[DI6]	<i>L, I...L, B</i>	Digital input DI1...DI6
[DI11]...[DI16]	<i>L, I, I...L, IB</i>	Digital input DI11...DI16 if VW3A3203 I/O extension module has been inserted
[CD00]...[CD10]	<i>C, D, D...C, D, D</i>	Virtual digital input CMD.0...CMD.10 in [I/O profile] io configuration
[CD11]...[CD15]	<i>C, d, I, I...C, d, I, S</i>	Virtual digital input CMD.11...CMD.15 regardless of configuration
[C100]...[C110]	<i>C, I, D, D...C, I, I, D</i>	Virtual digital input CMD1.0...CMD1.10 with integrated Modbus Serial in [I/O profile] io configuration
[C111]...[C115]	<i>C, I, I, I...C, I, I, S</i>	Virtual digital input CMD1.11...CMD1.15 with integrated Modbus Serial regardless of configuration
[C300]...[C310]	<i>C, 3, D, D...C, 3, I, D</i>	Virtual digital input CMD3.0...CMD3.10 with a fieldbus module in [I/O profile] io configuration
[C311]...[C315]	<i>C, 3, I, I...C, 3, I, S</i>	Virtual digital input CMD3.11...CMD3.15 with a fieldbus module regardless of configuration

[Ramp Divider] dCF ★

Fast Stop deceleration ramp reduction coefficient.

This parameter can be accessed if:

- **[Type of stop] SLE** is set to **[Fast stop] FSE**, and
- **[Fast stop assign.] FSE** is not set to **[No] no**, and
- **[Stop type] PFS** is set to **[Fast stop] FSE**.

The ramp that is enabled (**[Deceleration] DEL** or **[Deceleration 2] DE2**) is then divided by this coefficient when stop requests are sent.

Value 0 corresponds to a minimum ramp time.

Setting ()	Description
0...10	Setting range Factory setting: 4

[DC Injection Assign] d C ,

DC injection brake assignment.

⚠ WARNING
<p>UNINTENDED MOVEMENT</p> <ul style="list-style-type: none"> Do not use DC injection to generate holding torque when the motor is at a standstill. Use a holding brake to keep the motor in the standstill position. <p>Failure to follow these instructions can result in death, serious injury, or equipment damage.</p>

DC injection braking is initiated when the assigned input or bit changes to state 1.

If the input returns to state 0 and the run command is still active, the motor will only restart if **[2/3-wire control] E C C** is set to **[2-Wire Control] Z C** and if **[2-wire type] E C E** is set to **[Level] L E L** or **[Fwd priority] P F a**. If not, a new run command must be sent.

NOTE: This function cannot be used with some other functions. Follow the instructions about the compatibility of functions.

Setting	Code / Value	Description
[Not Assigned]	n a	Not assigned Factory setting
[DI1]...[DI6]	L , I...L , B	Digital input DI1...DI6
[DI11]...[DI16]	L , I I...L , I B	Digital input DI11...DI16 if VW3A3203 I/O extension module has been inserted
[CD00]...[CD10]	C d 0 0...C d 1 0	Virtual digital input CMD.0...CMD.10 in [I/O profile] , a configuration
[CD11]...[CD15]	C d 1 1...C d 1 5	Virtual digital input CMD.11...CMD.15 regardless of configuration
[C100]...[C110]	C 1 0 0...C 1 1 0	Virtual digital input CMD1.0...CMD1.10 with integrated Modbus Serial in [I/O profile] , a configuration
[C111]...[C115]	C 1 1 1...C 1 1 5	Virtual digital input CMD1.11...CMD1.15 with integrated Modbus Serial regardless of configuration
[C300]...[C310]	C 3 0 0...C 3 1 0	Virtual digital input CMD3.0...CMD3.10 with a fieldbus module in [I/O profile] , a configuration
[C311]...[C315]	C 3 1 1...C 3 1 5	Virtual digital input CMD3.11...CMD3.15 with a fieldbus module regardless of configuration

[DC inject. level 1] , d C ★

DC injection current.

NOTICE
<p>OVERHEATING AND DAMAGE TO THE MOTOR</p> <p>Verify that the connected motor is properly rated for the DC injection current to be applied in terms of amount and time in order to avoid overheating and damage to the motor.</p> <p>Failure to follow these instructions can result in equipment damage.</p>

Level of DC injection braking current activated via digital input or selected as stop mode.

This parameter can be accessed if:

- [Type of stop] S E E** is set to **[DC injection] d C ,** or
- [DC.Brake DI] d C ,** is not set to **[No] n a**.

Setting ()	Description
0.1...1.41 In ⁽¹⁾	Setting range This setting is independent of the [Auto DC Injection] A d C - function. Factory setting: 0.64 In ⁽¹⁾
(1) In corresponds to the rated drive current indicated in the Installation Manual and on the drive nameplate.	

[DC injection time 1] t_{d1} ★

DC injection time 1.

NOTICE**OVERHEATING AND DAMAGE TO THE MOTOR**

Verify that the connected motor is properly rated for the DC injection current to be applied in terms of amount and time in order to avoid overheating and damage to the motor.

Failure to follow these instructions can result in equipment damage.

Maximum current injection time **[DC inject. level 1] i_{dC1}** . After, the current becomes **[DC inject. level 2] i_{dC2}** . This parameter can be accessed if:

- **[Type of stop] S_{TE}** is set to **[DC injection] $dC1$** , or
- **[DC.Brake DI] $dC1$** is not set to **[No] $n0$** .

Setting (s)	Description
0.1...30 s	Setting range This setting is independent of the [Auto DC Injection] A_{dC} - function. Factory setting: 0.5 s

[DC inject. level 2] i_{dC2} ★

DC injection current 2.

NOTICE**OVERHEATING AND DAMAGE TO THE MOTOR**

Verify that the connected motor is properly rated for the DC injection current to be applied in terms of amount and time in order to avoid overheating and damage to the motor.

Failure to follow these instructions can result in equipment damage.

Injection current activated by digital input or selected as stop mode once period **[DC injection time 1] t_{d1}** has elapsed.

This parameter can be accessed if:

- **[Type of stop] S_{TE}** is set to **[DC injection] $dC1$** , or
- **[DC.Brake DI] $dC1$** is not set to **[No] $n0$** .

Setting (A)	Description
0.1 In ⁽¹⁾ ... [DC inject. level 1] i_{dC1}	Setting range This setting is independent of the [Auto DC Injection] A_{dC} - function. Factory setting: 0.5 In ⁽¹⁾
(1) In corresponds to the rated drive current indicated in the Installation Manual and on the drive nameplate.	

[DC Inj Time 2] t_{dC} ★

2nd DC injection time.

NOTICE**OVERHEATING AND DAMAGE TO THE MOTOR**

Verify that the connected motor is properly rated for the DC injection current to be applied in terms of amount and time in order to avoid overheating and damage to the motor.

Failure to follow these instructions can result in equipment damage.

Maximum injection time **[DC inject. level 2] i_{dC2}** for injection, selected as stop mode only. This parameter can be accessed if **[Type of stop] S_{TE}** is set to **[DC injection] $dC1$** .

Setting (s)	Description
0.1...30 s	Setting range This setting is independent of the [Auto DC Injection] A_{dC} - function. Factory setting: 0.5 s

Section 6.6

[Generic functions] - [Auto DC injection]

[Auto DC injection] *A d C* - Menu

Access

[Complete settings] → [Generic functions] → [Auto DC injection]

About This Menu

This menu presents the automatic injection of motor current function. This is used to hold the rotor of the motor at the end of the deceleration ramp.

[Auto DC Injection] *A d C*

Automatic DC Injection.

 **DANGER**

HAZARD OF ELECTRIC SHOCK, EXPLOSION, OR ARC FLASH

If the parameter **[Auto DC Injection] *A d C*** is set to **[Continuous] *C t***, DC injection is always active, even if the motor does not run.

- Verify that using this setting does not result in unsafe conditions.

Failure to follow these instructions will result in death or serious injury.

 **WARNING**

UNINTENDED MOVEMENT

- Do not use DC injection to generate holding torque when the motor is at a standstill.
- Use a holding brake to keep the motor in the standstill position.

Failure to follow these instructions can result in death, serious injury, or equipment damage.

Automatic current injection on stopping (at the end of the ramp).

NOTE: There is an interlock between this function and **[Motor fluxing] *F L u***. If **[Motor fluxing] *F L u*** is set to **[Continuous] *F C t***, **[Auto DC Injection] *A d C*** must be **[No] *n o***.

[Auto DC Injection] *A d C* is forced to **[No] *n o*** when **[Brake assignment] *b L C*** is not set to **[No] *n o***. This parameter gives rise to the injection of current even if a run command has not been sent.

Setting 	Code / Value	Description
[No]	<i>n o</i>	No injection
[Yes]	<i>y e s</i>	Adjustable injection time Factory setting
[Continuous]	<i>C t</i>	Continuous standstill injection

[Auto DC inj Level 1] 5 d C 1 ★

Auto DC injection level 1.

NOTICE**OVERHEATING AND DAMAGE TO THE MOTOR**

Verify that the connected motor is properly rated for the DC injection current to be applied in terms of amount and time in order to avoid overheating and damage to the motor.

Failure to follow these instructions can result in equipment damage.

Level of standstill DC injection current **[Auto DC Injection] R d C** is not **[No] n o**.

Setting ()	Description
0...1.2 In ⁽¹⁾	Setting range Factory setting: 0.7 In ⁽¹⁾
(1) In corresponds to the rated drive current indicated in the Installation Manual and on the drive nameplate.	

[Auto DC Inj Time 1] t d C 1 ★

Auto DC injection time 1.

NOTICE**OVERHEATING AND DAMAGE TO THE MOTOR**

Verify that the connected motor is properly rated for the DC injection current to be applied in terms of amount and time in order to avoid overheating and damage to the motor.

Failure to follow these instructions can result in equipment damage.

This parameter can be accessed if **[Auto DC Injection] R d C** is not set to **[No] n o**.

If **[Motor control type] C t t** is set to **[SYN_U VC] 5 Y n u**, this time corresponds to the zero speed maintenance time.

Setting ()	Description
0.1...30.0 s	Setting range Factory setting: 0.5 s

[Auto DC inj Level 2] 5 d C 2 ★

Auto DC injection level 2.

NOTICE**OVERHEATING AND DAMAGE TO THE MOTOR**

Verify that the connected motor is properly rated for the DC injection current to be applied in terms of amount and time in order to avoid overheating and damage to the motor.

Failure to follow these instructions can result in equipment damage.

Second level of standstill DC injection current.

This parameter can be accessed if **[Auto DC Injection] R d C** is not set to **[No] n o**.

Setting ()	Description
0...1.2 In ⁽¹⁾	Setting range Factory setting: 0.5 In ⁽¹⁾
(1) In corresponds to the rated drive current indicated in the Installation Manual and on the drive nameplate.	

[Auto DC Inj Time 2] *E d C 2* ★

Auto DC injection time 2.

NOTICE
OVERHEATING AND DAMAGE TO THE MOTOR
Verify that the connected motor is properly rated for the DC injection current to be applied in terms of amount and time in order to avoid overheating and damage to the motor.
Failure to follow these instructions can result in equipment damage.

Second standstill injection time.

This parameter can be accessed if [Auto DC Injection] *R d C* is set to [YES] *Y E 5*.

AdC	SdC2	Operation
YES	x	
Ct	≠ 0	
Ct	= 0	
Run command		
Speed		

Setting (i)	Description
0.0...30.0 s	Setting range Factory setting: 0.0 s

Section 6.7

[Generic functions] - [Preset speeds]

[Preset speeds] P 5 5 - Menu

Access

[Complete settings] → [Generic functions] → [Preset speeds]

About This Menu

NOTE: This function cannot be used with some other functions. Follow the instructions about the compatibility of functions.

Combination Table for Preset Speed Inputs

2, 4, 8 or 16 speeds can be preset, requiring 1, 2, 3 or 4 digital inputs respectively.

It is necessary to configure:

- 2 and 4 speeds in order to obtain 4 speeds.
- 2, 4 and 8 speeds in order to obtain 8 speeds.
- 2, 4, 8 and 16 speeds in order to obtain 16 speeds.

16 Preset Freq (PS16)	8 Preset Freq (PS8)	4 Preset Freq (PS4)	2 Preset Freq (PS2)	Speed Reference
0	0	0	0	Reference 1 ⁽¹⁾
0	0	0	1	SP2
0	0	1	0	SP3
0	0	1	1	SP4
0	1	0	0	SP5
0	1	0	1	SP6
0	1	1	0	SP7
0	1	1	1	SP8
1	0	0	0	SP9
1	0	0	1	SP10
1	0	1	0	SP11
1	0	1	1	SP12
1	1	0	0	SP13
1	1	0	1	SP14
1	1	1	0	SP15
1	1	1	1	SP16

(1) Reference 1 = 5 P I, refer to diagram (see page 142)

[2 Preset Freq] P 5 2

2 preset freq assignment.

Setting	Code / Value	Description
[Not Assigned]	n a	Not assigned Factory setting
[DI1]...[DI6]	L , I ... L , 6	Digital input DI1...DI6
[DI11]...[DI16]	L , I I I ... L , 16	Digital input DI11...DI16 if VW3A3203 I/O extension module has been inserted
[CD00]...[CD10]	C d 0 0 ... C d 1 0	Virtual digital input CMD.0...CMD.10 in [I/O profile] , a configuration
[CD11]...[CD15]	C d 1 1 ... C d 1 5	Virtual digital input CMD.11...CMD.15 regardless of configuration
[C100]...[C110]	C 1 0 0 ... C 1 1 0	Virtual digital input CMD1.0...CMD1.10 with integrated Modbus Serial in [I/O profile] , a configuration
[C111]...[C115]	C 1 1 1 ... C 1 1 5	Virtual digital input CMD1.11...CMD1.15 with integrated Modbus Serial regardless of configuration
[C300]...[C310]	C 3 0 0 ... C 3 1 0	Virtual digital input CMD3.0...CMD3.10 with a fieldbus module in [I/O profile] , a configuration
[C311]...[C315]	C 3 1 1 ... C 3 1 5	Virtual digital input CMD3.11...CMD3.15 with a fieldbus module regardless of configuration

[4 Preset Freq] P 5 4

4 preset freq assignment.

Identical to **[2 Preset Freq] P 5 2**

To obtain 4 speeds, you must also configure 2 speeds.

[8 Preset Freq] P 5 B

8 preset freq assignment.

Identical to **[2 Preset Freq] P 5 2**

To obtain 8 speeds, you must also configure 2 and 4 speeds.

[16 Preset Freq] P 5 16

16 preset freq assignment.

Identical to **[2 Preset Freq] P 5 2**

To obtain 8 speeds, you must also configure 2 and 4 speeds.

[Preset speed 2] 5 P 2 ★

Preset speed 2. See the combination table for preset speed inputs ([see page 161](#)).

Setting ()	Description
0.0...500.0 Hz	Setting range Factory setting: 10.0 Hz

[Preset speed 3] 5 P 3 ★

Preset speed 3. See the combination table for preset speed inputs ([see page 161](#)).

Setting ()	Description
0.0...500.0 Hz	Setting range Factory setting: 20.0 Hz

[Preset speed 4] 5 P 4 ★

Preset speed 4. See the combination table for preset speed inputs ([see page 161](#)).

Setting ()	Description
0.0...500.0 Hz	Setting range Factory setting: 30.0 Hz

[Preset speed 5] 5 P 5 ★

Preset speed 5. See the combination table for preset speed inputs ([see page 161](#)).

Setting ()	Description
0.0...500.0 Hz	Setting range Factory setting: 40.0 Hz

[Preset speed 6] 5 P 6 ★

Preset speed 6. See the combination table for preset speed inputs ([see page 161](#)).

Setting ()	Description
0.0...500.0 Hz	Setting range Factory setting: 30.0 Hz

[Preset speed 7] 5 P 7 ★

Preset speed 7. See the combination table for preset speed inputs ([see page 161](#)).

Setting ()	Description
0.0...500.0 Hz	Setting range Factory setting: 35.0 Hz

[Preset speed 8] 5 P 8 ★

Preset speed 8. See the combination table for preset speed inputs ([see page 161](#)).

Setting ()	Description
0.0...500.0 Hz	Setting range Factory setting: 40.0 Hz

[Preset speed 9] 5 P 9 ★

Preset speed 9. See the combination table for preset speed inputs ([see page 161](#)).

Setting ()	Description
0.0...500.0 Hz	Setting range Factory setting: 45.0 Hz

[Preset speed 10] 5 P 10 ★

Preset speed 10. See the combination table for preset speed inputs ([see page 161](#)).

Setting ()	Description
0.0...500.0 Hz	Setting range Factory setting: 50.0 Hz

[Preset speed 11] 5 P 11 ★

Preset speed 11. See the combination table for preset speed inputs ([see page 161](#)).

Setting ()	Description
0.0...500.0 Hz	Setting range Factory setting: 55.0 Hz

[Preset speed 12] 5 P 12 ★

Preset speed 12. See the combination table for preset speed inputs ([see page 161](#)).

Setting ()	Description
0.0...500.0 Hz	Setting range Factory setting: 60.0 Hz

[Preset speed 13] 5 P 13 ★

Preset speed 13. See the combination table for preset speed inputs ([see page 161](#)).

Setting ()	Description
0.0...500.0 Hz	Setting range Factory setting: 70.0 Hz

[Preset speed 14] 5 P 14 ★

Preset speed 14. See the combination table for preset speed inputs ([see page 161](#)).

Setting ()	Description
0.0...500.0 Hz	Setting range Factory setting: 80.0 Hz

[Preset speed 15] 5 P 15 ★

Preset speed 15 See the combination table for preset speed inputs ([see page 161](#)).

Setting ()	Description
0.0...500.0 Hz	Setting range Factory setting: 90.0 Hz

[Preset speed 16] 5 P 16 ★

Preset speed 16. See the combination table for preset speed inputs ([see page 161](#)).

Setting ()	Description
0.0...500.0 Hz	Setting range Factory setting: 100.0 Hz

Section 6.8

[Generic functions] - [Jump frequency]

[Jump frequency] *JUF* - Menu

Access

[Complete settings] → [Fan] → [Jump frequency]

About This Menu

This parameter helps to prevent prolonged operation within an adjustable range around the regulated frequency.

This function can be used to help to prevent a speed, which could cause resonance, being reached. Setting the function to 0 renders it inactive.

[Skip Frequency] *JPF*

Jump frequency.

Setting ()	Description
0.0...500.0 Hz	Setting range Factory setting: 0.0 Hz

[Skip Frequency 2] *JF2*

Jump frequency 2.

Setting ()	Description
0.0...500.0 Hz	Setting range Factory setting: 0.0 Hz

[3rd Skip Frequency] *JF3*

Jump frequency 3.

Setting ()	Description
0.0...500.0 Hz	Setting range Factory setting: 0.0 Hz

[Skip.Freq.Hysteresis] *JFH* ★

Jump frequency bandwidth.

This parameter can be accessed if at least one skip frequency *JPF*, *JF2*, or *JF3* is different from 0.

Skip frequency range: between $JPF - JFH$ and $JPF + JFH$ for example.

This adjustment is common to the 3 frequencies *JPF*, *JF2*, *JF3*.

Setting ()	Description
0.1...10.0 Hz	Setting range Factory setting: 1.0 Hz

Section 6.9

[Generic functions] - [Define system units]

[Define system units] 5 4 C - Menu

Access

[Complete settings] → [Generic functions] → [Define system units]

About This Menu

In order to be easy to configure, commission, operate, and maintain, the drive uses the application units.

The physicals that are concerned by application units are:

- Pressure values
- Flow rate values
- Temperature values
- Currency values

NOTE: Some other default system units are automatically deduced from configurable system units or from other parameters.

System unit applies by default to all communication parameters and HMI (Plain Text Display Terminal, Web server, DTM-based software).

When a system unit is changed, there is no rescaling of values. Numerical values are kept, but the meaning of these values is not the same:

- After a change, the behavior of the product will not change (the system stays numerically the same).
- If new values are written through communication or through HMI in new unit, then the behavior is impacted. In that case, all parameters should be reconfigured according to the new selected unit.
- In order to avoid issues due to a modification of system unit parameters, system units should be modified only during the installation of the product and before the commissioning of the functions.

The precision of the physical values is selected at the same time as the unit.

By default, values are signed.

Default range of values are:

16 bits values	32 bits values
-32,768...32,767	-2,147,483,648...2,147,483,648

[P sensor unit] 5 u P r

Default system application unit used for pressure.

Available pressure units:

Unit	Symbol	Conversion
Kilo Pascal	kPa	100 kPa = 1 bar
Millibar	mbar	
Bar	bar	
Pound / square inch (lb/in ²)	psi psig	14.5 psi = 1 bar
Inch H2O Inch water gauge Inch water column	inH2O inWG inWC	1 inH2O 4°C = 0.0024908891 bar (0.036127292 psi)
Feet water gauge Feet water column Feet	ftWG ftWC ft	1 inH2O 4°C = 0.0298906692 bar (0.433527504 psi)
Meter water gauge Meter water column Meter	mWG mWC (mCE) m	1 mH2O(4°C) = 0.0980665 bar (1.42233433 psi)
Inch of mercury	inHg	1 inHg = 0.0338638864 bar (0.491154147 psi)
Percentage	%	–
w/o unit	–	–

Setting	Code / Value	Description
[1Kpa]	<i>P A</i>	1 kpa
[1mbar]	<i>1 m b a r</i>	1 mbar
[1Bar]	<i>b a r</i>	1 bar
[0.1Bar]	<i>0.1 b a r</i>	0.1 bar Factory setting
[0.01Bar]	<i>0.01 b a r</i>	0.01 bar
[1 PSI]	<i>P S I</i>	1 Psi
[0.1 PSI]	<i>0.1 P S I</i>	0.1 psi
[1 PSIG]	<i>P S I G</i>	1 Psig
[0.1 PSIG]	<i>0.1 P S I G</i>	0.1 Psig
[1inH20]	<i>1 i n H 2 0</i>	1 inH20
[1inWg]	<i>1 i n W G</i>	1 inWg
[1inWC]	<i>1 i n W C</i>	1 inWc
[1 FtWg]	<i>1 F t W G</i>	1 FtWg
[1 FtWC]	<i>1 F t W C</i>	1 FtWC
[1 Ft]	<i>1 F t</i>	1 Ft
[1 MWG]	<i>1 m W G</i>	1 mWg
[0.1 MWG]	<i>0.1 m W G</i>	0.1 mWg
[1 MWC]	<i>1 m W C</i>	1 mWC
[0.1 MWC]	<i>0.1 m W C</i>	0.1 mWC
[1m]	<i>1 m ?</i>	1 m
[0.1 m]	<i>0.1 m ?</i>	0.1 m
[1 inHG]	<i>1 i n H G</i>	1 inHg
[0.1%]	<i>0.1 ? ?</i>	0.1%
[0.1]	<i>0.1 ? w ? o ?</i>	0.1 w/o

[Flow rate unit] 5 U F r

Default system application unit used for flow rate.

Available flow units:

Unit	Symbol	Conversion
Liter / second	l/s	–
Liter / minute	l/min	–
Liter / hour	l/h	–
Cubic decimeter / minute	dm ³ /min	–
Cubic meter / second	m ³ /s	–
Cubic meter / minute	m ³ /min	–
Cubic meter / hour	m ³ /h	–
Gallon per second	gal/s	1 usgal = 3,785411784 l
Gallon per minute	gal/min; GPM	–
Gallon per hour	gal/h	–
Cubic feet / second	ft ³ /s	1 ft ³ = 28.317 l
Cubic feet / minute	ft ³ /min; CFM, SCFM	–
Cubic feet / hour	ft ³ /h	–
Percentage	%	–
w/o unit	–	–

Setting	Code / Value	Description
[1 L/s]	1 L S	L/s
[l/s]	0 1 L S	0.1 L/s
[1 L/m]	1 L m	L/m
[1 L/h]	1 L h	L/h
[1 dm ³ /mn]	1 d m ³ m	d ³ /m
[1 m ³ /s]	1 m ³ S	M ³ /s
[0.1 m ³ /sec]	0 1 m ³ S	0.1 M ³ /s
[1m ³ /m]	1 m ³ m	M ³ /min
[0.1 m ³ /m]	0 1 m ³ m	0.1 M ³ /min
[1 m ³ /h]	1 m ³ h	1 M ³ /h
[0.1m ³ /h]	0 1 m ³ h	0.1 M ³ /h Factory setting
[1 gal/sec]	1 G P S	1 Gal/s
[1 GPM]	1 G P m	1 GPM
[1 gal/h]	1 G P h	1 Gal/h
[1 ft ³ /sec]	1 C F S	1 ft ³ /s
[1CFM]	1 C F m	1 CFM
[1SCFM]	1 S C F m	1 SCFM
[1 Ft ³ /h]	1 C F h	1 ft ³ /h
[1 Kg/s]	1 G S	1 kg/s
[1 Kg/m]	1 G m	1 kg/m
[1 Kg/h]	1 G h	1 kg/h
[1 Lb/s]	1 L b S	1 lb/s
[1 Lb/m]	1 L b m	1 lb/m
[1 Lb/h]	1 L b h	1 lb/h
[0.1%]	0 1 P C	0.1%
[0.1]	0 1 w o ?	0.1 w/o

[Temperature unit] S U L P

Default system application unit used for temperature.

Available temperature units:

Unit	Symbol	Conversion
Celsius Degree	°C	–
Fahrenheit Degree	°F	$TF = 9/5 * T_C + 32$
Percentage	%	–
w/o unit	–	–

Setting	Code / Value	Description
[0.1°C]	<i>D. 1°C</i>	0.1 °C Factory setting
[0.1°F]	<i>D. 1°F</i>	0.1 °F
[0.1%]	<i>D. 1%</i>	0.1%
[0.1]	<i>D. 1 w/o</i>	0.1 w/o

[Currency unit list] S U C U

Default system application unit used for currency.

Setting	Code / Value	Description
[EURO]	<i>E u r o</i>	Euro
[\$]	<i>?</i>	Dollar
[£]	<i>?</i>	Pound
[Krone]	<i>K r</i>	Krone
[Renminbi]	<i>r n b</i>	Renminbi Factory setting
[Other]	<i>a t h e r</i>	Other

Section 6.10

[Generic functions] - [PID controller]

What Is in This Section?

This section contains the following topics:

Topic	Page
[PID controller] P, d - Overview	171
[Feedback] Fdb - Menu	174
[Reference frequency] rF - Menu	180
[PID preset references] Pr, i - Menu	182
[Reference frequency] rF - Menu	184
[Settings] St - Menu	185

[PID controller] P i d - Overview

About This Menu

NOTE: This function cannot be used with some other functions. Follow the instructions about the compatibility of functions.

Block Diagram

The function is activated by assigning an analog input to the **[PID feedback]** (measurement).

The **[PID feedback]** needs to be assigned to one of the analog inputs AI1 to AI5 or a pulse input, according to whether any I/O extension module has been inserted.

The **[PID reference]** needs to be assigned to the following parameters:

- Preset references via digital inputs ($r P 2$, $r P 3$, $r P 4$).
- In accordance with the configuration of **[Intern PID Ref] P i i**:
 - **[Internal PID ref] r P i**, or
 - Reference A **[Config Ref Freq 1] F r 1** or **[Ref.1B channel] F r 1 b**.

Combination Table for Preset PID References:

DI (P r 4)	DI (P r 2)	P r 2 = n o	Reference
			$r P i$ or $F r 1 ? b ?$
0	0		$r P i$ or $F r 1 ? b ?$
0	1		$r P 2$
1	0		$r P 3$
1	1		$r P 4$

A predictive speed reference can be used to initialize the speed on restarting the process.

Scaling of feedback and references:

- **[Min PID feedback] P i F 1**, **[Max PID feedback] P i F 2** parameters can be used to scale the PID feedback (sensor range). **This scale MUST be maintained for all other parameters.**
- **[Min PID Process] P i P 1**, **[Max PID Process] P i P 2** parameters can be used to scale the adjustment range, for example the reference. **The adjustment range MUST remain within the sensor range.**

The maximum value of the scaling parameters is 32,767. To facilitate the installation, it is recommended to use values as close as possible to this maximum level, while retaining powers of 10 in relation to the actual values. The scaling is without unit if **[Type of control] t o C t** is set to **[NA] n A**, in % if set to **[OTHER] o t H E r**, in process unit if set **[toPRESSURE] P r E S S** or **[FLOW] F L o W**.

Example

Adjustment of the volume in a tank, 6...15 m³.

- Probe used 4-20 mA, 4.5 m³ for 4 mA and 20 m³ for 20 mA, with the result that $P, F, I = 4,500$ and $P, F, Z = 20,000$.
- Adjustment range 6 to 15 m³, with the result that $P, P, I = 6,000$ (min. reference) and $P, P, Z = 15,000$ (max. reference).
- Example references:
 - r, P, I (internal reference) = 9,500
 - r, P, Z (preset reference) = 6,500
 - $r, P, 3$ (preset reference) = 8,000
 - $r, P, 4$ (preset reference) = 11,200

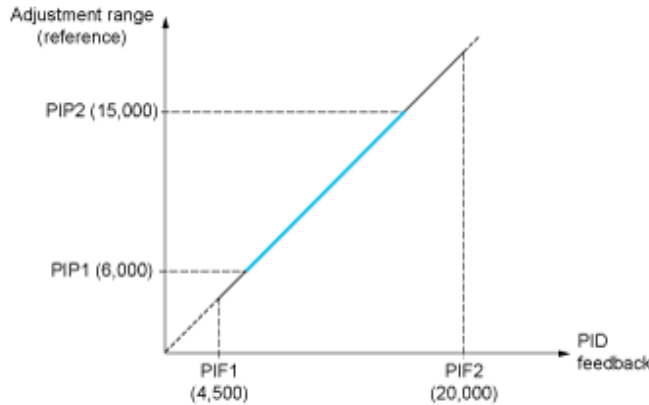

Other parameters:

- Reversal of the direction of correction **[PID Inversion] P, C**. If **[PID Inversion] P, C** is set to **[No]** n, o , the speed of the motor increases when the detected error is positive (for example pressure control with a compressor). If **[PID Inversion] P, C** is set to **[Yes]** y, e, s , the speed of the motor decreases when the detected error is positive (for example temperature control using a cooling fan).
- The integral gain may be short-circuited by a digital input.
- A warning on the **[PID feedback]** may be configured.
- A warning on the **[PID error]** may be configured.

"Manual - Automatic" Operation with PID

This function combines the **[PID controller]**, the preset speeds, and a manual reference. Depending on the state of the digital input, the speed reference is given by the preset speeds or by a manual reference input via the PID function.

[Manual PID reference] P, P:

- Analog inputs AI1 to AI5
- Pulse inputs

Predictive speed reference **[Predictive Speed Ref] F P, :**

- **[AI1] A, 1:** Analog input
- **[AI2] A, 2:** Analog input
- **[AI3] A, 3:** Analog input
- **[AI4] A, 4:** Analog input
- **[AI5] A, 5:** Analog input
- **[DI5 PulseInput Assignment] P, 5:** pulse input
- **[DI6 PulseInput Assignment] P, 6:** pulse input
- **[Ref.Freq-Rmt.Term] L, C, C:** Plain Text Display Terminal
- **[Modbus] M, d, b:** integrated Modbus
- **[Com. card] n, E, E:** Fieldbus option module (if inserted)

Setting Up the [PID controller]

1. Configuration in PID mode.

Refer to the Block Diagram (see page 171).

2. Perform a test in factory settings mode.

To optimize the drive, adjust [PID Prop.Gain] rPG or [PID Intgl.Gain] rIG gradually and independently, and observe the effect on the PID feedback in relation to the reference.

3. If the factory settings are unstable or the reference is incorrect.

Step	Action
1	Perform a test with a speed reference in Manual mode (without PID regulator) and with the drive on load for the speed range of the system: <ul style="list-style-type: none"> ● In steady state, the speed must be stable and comply with the reference, and the PID feedback signal must be stable. ● In transient state, the speed must follow the ramp and stabilize quickly, and the PID feedback must follow the speed. If not, see the settings for the drive and/or sensor signal and wiring.
2	Switch to PID mode.
3	Set [PID ramp] rPP to the minimum permitted by the mechanism without triggering an [DC Bus Overvoltage] oBF .
4	Set the integral gain [PID Intgl.Gain] rIG to minimum.
5	Leave the derivative gain [PID derivative gain] rdG at 0.
6	Observe the PID feedback and the reference.
7	Switch the drive ON/OFF a number of times or vary the load or reference rapidly a number of times.
8	Set the proportional gain [PID Prop.Gain] rPG in order to ascertain the compromise between response time and stability in transient phases (slight overshoot and 1 to 2 oscillations before stabilizing).
9	If the reference varies from the preset value in steady state, gradually increase the integral gain [PID Intgl.Gain] rIG , reduce the proportional gain [PID Prop.Gain] rPG in the event of instability (pump applications), find a compromise between response time and static precision (see diagram).
10	Lastly, the derivative gain may permit the overshoot to be reduced and the response time to be improved, although this is more difficult to obtain a compromise in terms of stability, as it depends on 3 gains.
11	Perform in-production tests over the whole reference range.

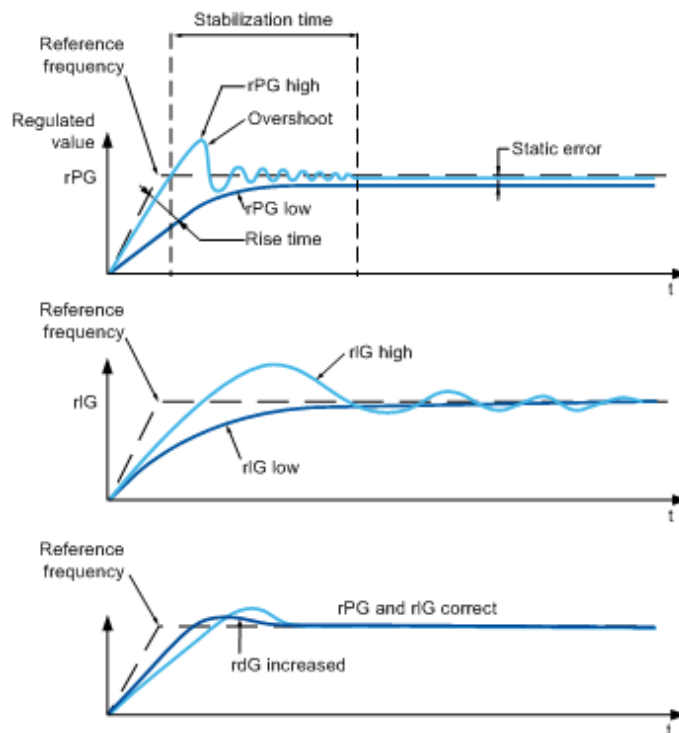

The oscillation frequency depends on the system kinematics:

Parameter	Rise time	Overshoot	Stabilization time	Static Error
rPG +	--	+	=	-
rIG +	-	++	+	--
rdG +	=	-	-	=

[Feedback] F d b - Menu

Access

[Complete settings] → [Generic functions] → [PID controller] → [Feedback]

About This Menu

NOTE: This function cannot be used with some other functions. Follow the instructions about the compatibility of functions.

[Type of Control] L o C L

Type of control for the PID = unit choice.

Setting	Code / Value	Description
[nA]	n R	Nothing special Factory setting
[P]	P	Pressure control and unit
[F]	F	Flow control and unit
[O]	o	Other control and unit

[PID Feedback] P , F

PID function feedback assignment.

Setting	Code / Value	Description
[No]	n o	Not assigned Factory setting
[AI1]...[AI3]	R , 1...R , 3	Analog input AI1...AI3
[AI4]...[AI5]	R , 4...R , 5	Analog input AI4...AI5 if VW3A3203 I/O extension module has been inserted
[AI Virtual 1]	R , u 1	Virtual analogic input 1
[PulseInput Assignment On DI5]...[PulseInput Assignment On DI6]	P , 5...P , 6	Digital input DI5...DI6 used as pulse input

[AI1 Type] R , I L ★

Configuration of analog input AI1.

This parameter can be accessed if [PID Feedback] P , F is set to [AI1] R , I .

Setting	Code / Value	Description
[Voltage]	I D u	0-10 Vdc Factory setting
[Current]	D R	0-20 mA

[AI1 min value] u , L / ★

AI1 voltage scaling parameter of 0%.

This parameter can be accessed if:

- [PID Feedback] P , F is set to [AI1] R , I
- [AI1 Type] R , I L is not set to [Voltage] I D u .

Setting	Description
0.0...10.0 V	Setting range Factory setting: 0.0 V

[AI1 max value] \cup, H, I ★

AI1 voltage scaling parameter of 100%.

This parameter can be accessed if:

- **[PID Feedback] P, F** is set to **[AI1] R, I**
- **[AI1 Type] R, I, E** is not set to **[Voltage] I, D, \cup** .

Setting	Description
0.0...10.0 V	Setting range Factory setting: 10.0 V

[AI1 min. value] C, r, L, I ★

AI1 current scaling parameter of 0%.

This parameter can be accessed if:

- **[PID Feedback] P, F** is set to **[AI1] R, I**
- **[AI1 Type] R, I, E** is not set to **[Current] D, R** .

Setting	Description
0.0...20.0 mA	Setting range Factory setting: 0.0 mA

[AI1 max. value] C, r, H, I ★

AI1 current scaling parameter of 100%.

This parameter can be accessed if:

- **[PID Feedback] P, F** is set to **[AI1] R, I**
- **[AI Type] R, I, E** is not set to **[Current] D, R** .

Setting	Description
0.0...20.0 mA	Setting range Factory setting: 20.0 mA

[AI2 Type] $R, I, 2, E$ ★

Configuration of analog input AI2.

This parameter can be accessed if **[PID Feedback] P, F** is set to **[AI2] $R, I, 2$**

Setting	Code / Value	Description
[Voltage]	I, D, \cup	0-10 Vdc
[Current]	D, R	0-20 mA Factory setting
[PTC Management]	P, E, C	1 to 6 PTC (in serial)
[KTY]	K, E, Y	1 KTY84
[PT1000]	$I, P, E, 3$	1 PT1000 connected with 2 wires
[PT100]	$I, P, E, 2$	1 PT100 connected with 2 wires
[Water Prob]	L, E, \cup, E, L	Water level
[3PT1000]	$3, P, E, 3$	3 PT1000 connected with 2 wires
[3PT100]	$3, P, E, 2$	3 PT100 connected with 2 wires

[AI2 min value] $\cup, I, L, 2$ ★

AI2 voltage scaling parameter of 0%.

This parameter can be accessed if:

- **[PID Feedback] P, F** is set to **[AI2] $R, I, 2$**
- **[AI2 Type] $R, I, 2, E$** is not set to **[Voltage] I, D, \cup** .

Identical to **[AI1 min value] \cup, I, L, I** (see page 174).

[AI2 max value] U, H 2 ★

AI2 voltage scaling parameter of 100%.

This parameter can be accessed if:

- **[PID Feedback] P, F** is set to **[AI2] A, 2**
- **[AI2 Type] A, 2 E** is not set to **[Voltage] I D U**.

Identical to **[AI1 max value] U, H 1** (see page 175).

[AI2 min. value] C, L 2 ★

AI2 current scaling parameter of 0%.

This parameter can be accessed if:

- **[PID Feedback] P, F** is set to **[AI2] A, 2**
- **[AI2 Type] A, 2 E** is not set to **[Current] D A**.

Identical to **[AI1 min. value] C, L 1** (see page 175) with factory setting: 0.4 mA.

[AI2 max. value] C, H 2 ★

AI2 current scaling parameter of 100%.

This parameter can be accessed if:

- **[PID Feedback] P, F** is set to **[AI2] A, 2**
- **[AI2 Type] A, 2 E** is not set to **[Current] D A**.

Identical to **[AI1 max. value] C, H 1** (see page 175).

[AI3 Type] A, 3 E ★

Configuration of analog input AI3.

This parameter can be accessed if **[PID Feedback] P, F** is set to **[AI3] A, 3**.

Identical to **[AI2 Type] A, 2 E**.

[AI3 min value] U, L 3 ★

AI3 voltage scaling parameter of 0%.

This parameter can be accessed if:

- **[PID Feedback] P, F** is set to **[AI3] A, 3**
- **[AI3 Type] A, 3 E** is not set to **[Voltage] I D U**.

Identical to **[AI1 min value] U, L 1** (see page 174).

[AI3 max value] U, H 3 ★

AI3 voltage scaling parameter of 100%.

This parameter can be accessed if:

- **[PID Feedback] P, F** is set to **[AI3] A, 3**
- **[AI3 Type] A, 3 E** is not set to **[Voltage] I D U**.

Identical to **[AI1 max value] U, H 1** (see page 175).

[AI3 min. value] C, L 3 ★

AI3 current scaling parameter of 0%.

This parameter can be accessed if:

- **[PID Feedback] P, F** is set to **[AI3] A, 3**
- **[AI3 Type] A, 3 E** is not set to **[Current] D A**.

Identical to **[AI1 min. value] C, L 1** (see page 175).

[AI3 max. value] C r H 3 ★

AI3 current scaling parameter of 100%.

This parameter can be accessed if:

- **[PID Feedback] P , F** is set to **[AI3] R , 3**
- **[AI3 Type] R , 3 E** is not set to **[Current] D R**.

Identical to **[AI1 max. value] C r H 1** (see page 175).

[AI4 Type] R , 4 E ★

Configuration of analog input AI4.

This parameter can be accessed if:

- VW3A3203 I/O extension module has been inserted, and
- **[PID Feedback] P , F** is set to **[AI4] R , 4**.

Setting	Code / Value	Description
[Voltage]	I D u	0-10 Vdc
[Current]	D R	0-20 mA
[Voltage +/-]	n I D u	-10/+10 Vdc Factory setting
[PTC Management]	P E C	1 to 6 PTC (in serial)
[KTY]	K E Y	1 KTY84
[PT1000]	I P E 3	1 PT1000 connected with 2 wires
[PT100]	I P E 2	1 PT100 connected with 2 wires
[3 PT1000]	3 P E 3	3 PT1000 connected with 2 wires
[3 PT100]	3 P E 2	3 PT100 connected with 2 wires
[PT1000 in 3 wires]	I P E 3 3	1 PT1000 connected with 3 wires (AI4 & AI5 only)
[PT100 in 3 wires]	I P E 2 3	1 PT100 connected with 3 wires (AI4 & AI5 only)
[3 PT1000 in 3 wires]	3 P E 3 3	3 PT1000 connected with 3 wires (AI4 & AI5 only)
[3 PT100 in 3 wires]	3 P E 2 3	3 PT100 connected with 3 wires (AI4 & AI5 only)

[AI4 min value] u , L 4 ★

AI4 voltage scaling parameter of 0%.

This parameter can be accessed if:

- **[PID Feedback] P , F** is set to **[AI4] R , 4**
- **[AI4 Type] R , 4 E** is not set to **[Voltage] I D u**.

Identical to **[AI1 min value] u , L 1** (see page 174).

[AI4 max value] u , H 4 ★

AI4 voltage scaling parameter of 100%.

This parameter can be accessed if:

- **[PID Feedback] P , F** is set to **[AI4] R , 4**
- **[AI4 Type] R , 4 E** is not set to **[Voltage] I D u**.

Identical to **[AI1 max value] u , H 1** (see page 175).

[AI4 min. value] C r L 4 ★

AI4 current scaling parameter of 0%.

This parameter can be accessed if:

- **[PID Feedback] P , F** is set to **[AI4] R , 4**
- **[AI4 Type] R , 4 E** is not set to **[Current] D R**.

Identical to **[AI1 min. value] C r L 1** (see page 175).

[AI4 max. value] C r H 4 ★

AI4 current scaling parameter of 100%.

This parameter can be accessed if:

- **[PID Feedback] P , F** is set to **[AI4] R , 4**
- **[AI4 Type] R , 4 E** is not set to **[Current] D R**.

Identical to **[AI1 max. value] C r H 1** (see page 175).

[AI5 Type] R , 5 E ★

Configuration of analog input AI5.

This parameter can be accessed if:

- VW3A3203 I/O extension module has been inserted, and
- **[PID Feedback] P , F** is set to **[AI5] R , 5**.

Identical to **[AI4 Type] R , 4 E**.

[AI5 min value] u , L 5 ★

AI5 voltage scaling parameter of 0%.

This parameter can be accessed if:

- **[PID Feedback] P , F** is set to **[AI5] R , 5**
- **[AI4 Type] R , 5 E** is not set to **[Voltage] I D u**.

Identical to **[AI1 min value] u , L 1** (see page 174).

[AI5 max value] u , H 5 ★

AI5 voltage scaling parameter of 100%.

This parameter can be accessed if:

- **[PID Feedback] P , F** is set to **[AI5] R , 5**
- **[AI4 Type] R , 5 E** is not set to **[Voltage] I D u**.

Identical to **[AI1 max value] u , H 1** (see page 175).

[AI5 min. value] C r L 5 ★

AI5 current scaling parameter of 0%.

This parameter can be accessed if:

- **[PID Feedback] P , F** is set to **[AI5] R , 5**
- **[AI5 Type] R , 5 E** is not set to **[Current] D R**.

Identical to **[AI1 min. value] C r L 1** (see page 175).

[AI5 max. value] C r H 5 ★

AI5 current scaling parameter of 100%.

This parameter can be accessed if:

- **[PID Feedback] P , F** is set to **[AI5] R , 5**
- **[AI5 Type] R , 5 E** is not set to **[Current] D R**.

Identical to **[AI1 max. value] C r H 1** (see page 175).

[Min PID feedback] P , F 1 ★

Minimum PID feedback.

This parameter can be accessed if **[PID Feedback] P , F** is not set to **[No] n o**.

Setting ()	Description
0... [Max PID feedback] P , F 2	Setting range Factory setting: 100

[Max PID feedback] P , F 2 ★

Maximum PID feedback.

This parameter can be accessed if **[PID Feedback] P , F** is not set to **[No] n o .**

Setting ()	Description
[Min PID feedback] P , F 1...65,535	Setting range Factory setting: 1,000

[PID feedback] P , F ★

Value for PID feedback.

This parameter can be accessed if **[PID Feedback] P , F** is not set to **[No] n o .**

Setting	Description
[Min PID feedback] P , F 1...[Max PID feedback] P , F 2	Factory setting: 0

[Min Fbk Warning] P , F L ★

Minimum feedback level warning.

This parameter can be accessed if **[PID Feedback] P , F** is not set to **[No] n o .**

Setting ()	Description
[Min PID feedback] P , F 1...[Max PID feedback] P , F 2	Setting range Factory setting: 100

[Max Fbk Warning] P , F H ★

Maximum feedback level warning.

This parameter can be accessed if **[PID Feedback] P , F** is not set to **[No] n o .**

Setting ()	Description
[Min PID feedback] P , F 1...[Max PID feedback] P , F 2	Setting range Factory setting: 1,000

[Reference frequency] $r F$ - Menu

Access

[Complete settings] → [Generic functions] → [PID controller] → [Reference frequency]

About This Menu

NOTE: This function cannot be used with some other functions. Follow the instructions about the compatibility of functions.

[Intern PID Ref] P_{i1} ★

Internal PID reference.

This parameter can be accessed if [PID Feedback] P_{iF} is not set to [No] $n o$.

Setting	Code / Value	Description
[No]	$n o$	The PID controller reference is given by [Ref Freq 1 Config] F_{r1} or [Ref.1B channel] F_{r1b} with summing/subtraction/multiplication functions. Refer to the block diagram (see page 171). Factory setting
[Yes]	$y e s$	The PID controller reference is internal via [Internal PID ref] $r P_{i1}$.

[Ref Freq 1 Config] F_{r1} ★

Configuration reference frequency 1.

This parameter can be accessed if:

- [PID Feedback] P_{iF} is not set to [No] $n o$, and
- [Intern PID Ref] P_{i1} is set to [No] $n o$.

Setting	Code / Value	Description
[No]	$n o$	Not assigned Factory setting
[AI1]...[AI3]	$A_{i1}...A_{i3}$	Analog input AI1...AI3
[AI4]...[AI5]	$A_{i4}...A_{i5}$	Analog input AI4...AI5 if VW3A3203 I/O extension module has been inserted
[Ref.Freq-Rmt.Term]	$L C C$	Display terminal source
[Ref. Freq-Modbus]	$M d b$	Reference frequency via Modbus
[Ref. Freq-Com. Module]	$n e t$	Reference frequency via Com Module

[Min PID reference] P_{iP1} ★

Minimum PID reference.

This parameter can be accessed if [PID Feedback] P_{iF} is not set to [No] $n o$.

Setting ()	Description
[Min PID feedback] P_{iF1} ...[Max PID reference] P_{iP2}	Setting range Factory setting: 150

[Max PID reference] P_{iP2} ★

Maximum PID reference.

This parameter can be accessed if [PID Feedback] P_{iF} is not set to [No] $n o$.

Setting ()	Description
[Min PID reference] P_{iP1} ...[Max PID feedback] P_{iF2}	Setting range Factory setting: 900

[Internal PID ref] P , ★

Internal PID reference.

This parameter can be accessed if:

- **[PID Feedback] P , F** is not set to **[No] n o**, and
- **[Intern PID Ref] P , I** is set to **[Yes] Y E S**.

Setting ()	Description
[Min PID reference] P , P 1 ... [Max PID reference] P , P 2	Setting range Factory setting: 150

[Auto/Manual assign.] P A U ★

Auto/Manual select input.

This parameter can be accessed if **[PID Feedback] P , F** is not set to **[No] n o**.

Setting	Code / Value	Description
[Not Assigned]	n o	Not assigned Factory setting
[DI1]...[DI6]	L , 1...L , 6	Digital input DI1...DI6
[DI11]...[DI16]	L , 11...L , 16	Digital input DI11...DI16 if VW3A3203 I/O extension module has been inserted
[CD00]...[CD10]	C d 00...C d 10	Virtual digital input CMD.0...CMD.10 in [I/O profile] , o configuration
[CD11]...[CD15]	C d 11...C d 15	Virtual digital input CMD.11...CMD.15 regardless of configuration
[C100]...[C110]	C 100...C 110	Virtual digital input CMD1.0...CMD1.10 with integrated Modbus Serial in [I/O profile] , o configuration
[C111]...[C115]	C 111...C 115	Virtual digital input CMD1.11...CMD1.15 with integrated Modbus Serial regardless of configuration
[C300]...[C310]	C 300...C 310	Virtual digital input CMD3.0...CMD3.10 with a fieldbus module in [I/O profile] , o configuration
[C311]...[C315]	C 311...C 315	Virtual digital input CMD3.11...CMD3.15 with a fieldbus module regardless of configuration

[Manual PID Reference] P , Π ★

Manual PID reference.

Reference input in manual mode.

This parameter can be accessed if:

- **[PID Feedback] P , F** is not set to **[No] n o**, and
- **[Auto/Manual assign.] P A U** is not set to **[No] n o**.

The preset speeds are active on the manual reference if they have been configured.

Setting	Code / Value	Description
[No]	n o	Not assigned Factory setting
[AI1]...[AI3]	A , 1...A , 3	Analog input AI1...AI3
[AI4]...[AI5]	A , 4...A , 5	Analog input AI4...AI5 if VW3A3203 I/O extension module has been inserted
[Ref.Freq-Rmt.Term]	L C C	Display terminal source
[Ref. Freq-Modbus]	Π d b	Reference frequency via Modbus
[Ref. Freq-Com. Module]	n E t	Reference frequency via Com Module
[PulseInput Assignment On DI5]...[PulseInput Assignment On DI6]	P , 5...P , 6	Digital input DI5...DI6 used as pulse input

[PID preset references] P r 1 - Menu

Access

[Complete settings] → [Generic functions] → [PID controller] → [Reference frequency] → [PID preset references]

About This Menu

The function can be accessed if [PID feedback ass.] P r F is assigned.

[2 PID Preset Assign] P r 2

2 PID Preset assignment.

If the assigned input or bit is at 0, the function is inactive.

If the assigned input or bit is at 1, the function is active.

Setting	Code / Value	Description
[Not Assigned]	n o	Not assigned Factory setting
[DI1]...[DI6]	L 1 L ... L 6	Digital input DI1...DI6
[DI11]...[DI16]	L 11 L ... L 16	Digital input DI11...DI16 if VW3A3203 I/O extension module has been inserted
[CD00]...[CD10]	C d 0 0 ... C d 1 0	Virtual digital input CMD.0...CMD.10 in [I/O profile] , o configuration
[CD11]...[CD15]	C d 1 1 ... C d 1 5	Virtual digital input CMD.11...CMD.15 regardless of configuration
[C100]...[C110]	C 1 0 0 ... C 1 1 0	Virtual digital input CMD1.0...CMD1.10 with integrated Modbus Serial in [I/O profile] , o configuration
[C111]...[C115]	C 1 1 1 ... C 1 1 5	Virtual digital input CMD1.11...CMD1.15 with integrated Modbus Serial regardless of configuration
[C300]...[C310]	C 3 0 0 ... C 3 1 0	Virtual digital input CMD3.0...CMD3.10 with a fieldbus module in [I/O profile] , o configuration
[C311]...[C315]	C 3 1 1 ... C 3 1 5	Virtual digital input CMD3.11...CMD3.15 with a fieldbus module regardless of configuration
[DI1 (Low level)]...[DI6 (Low level)]	L 1 L ... L 6 L	Digital input DI1...DI6 used at low level
[DI11 (Low level)]...[DI16 (Low level)]	L 11 L ... L 16 L	Digital input DI11...DI16 used at low level if VW3A3203 I/O extension module has been inserted

[4 PID Preset Assign] P r 4

Enable 4 preset PI references.

Identical to [2 PID Preset Assign] P r 2 (see page 182).

Verify that [2 PID Preset Assign] P r 2 has been assigned before assigning this function.

[Ref PID Preset 2] r P 2 ★

Second PI preset reference.

This parameter can be accessed only if [2 PID Preset Assign] P r 2 is assigned.

Setting ()	Description
[Min PID reference] P r P 1 ... [Max PID reference] P r P 2	Setting range Factory setting: 300

[Ref PID Preset 3] *r P 3* ★

Third PI preset reference.

This parameter can be accessed only if **[4 PID Preset Assign]** *P r 4* is assigned.

Setting ()	Description
[Min PID reference] <i>P , P 1</i> ... [Max PID reference] <i>P , P 2</i>	Setting range Factory setting: 600

[Ref PID Preset 4] *r P 4* ★

Fourth PI preset reference.

This parameter can be accessed only if **[4 PID Preset Assign]** *P r 4* and **[2 PID Preset Assign]** *P r 2* are assigned.

Setting ()	Description
[Min PID reference] <i>P , P 1</i> ... [Max PID reference] <i>P , P 2</i>	Setting range Factory setting: 900

[Reference frequency] $r F$ - Menu**Access**

[Complete settings] → [Generic functions] → [PID controller] → [Reference frequency]

[Predictive Speed Ref] $F P$, ★

Predictive speed reference.

This parameter can be accessed if [Access Level] $L A C$ is set to [Expert] $E P r$.

Setting	Code / Value	Description
[No]	$n o$	Not assigned Factory setting
[AI1]...[AI3]	$A , 1 \dots A , 3$	Analog input AI1...AI3
[AI4]...[AI5]	$A , 4 \dots A , 5$	Analog input AI4...AI5 if VW3A3203 I/O extension module has been inserted
[Ref.Freq-Rmt.Term]	$L C C$	Display terminal source
[Ref. Freq-Modbus]	$M d b$	Reference frequency via Modbus
[Ref. Freq-Com. Module]	$n E t$	Reference frequency via Com Module
[PulseInput Assignment On DI5]...[PulseInput Assignment On DI6]	$P , 5 \dots P , 6$	Digital input DI5...DI6 used as pulse input

[Speed Input %] $P S r$ ★

PID speed input % reference.

This parameter can be accessed if [Access Level] $L A C$ is set to [Expert] $E P r$.

Setting ()	Description
1...100%	Setting range Factory setting: 100%

[Settings] 5 L - Menu

Access

[Complete settings] → [Generic functions] → [PID controller] → [Settings]

About This Menu

NOTE: This function cannot be used with some other functions. Follow the instructions about the compatibility of functions.

[PID Prop.Gain] $r P G$ ★

PID proportional gain.

This parameter can be accessed if [PID Feedback] P, F is not set to [Not Configured] $n o$.

Setting ()	Description
0.01...100	Setting range Factory setting: 1

[PI Intgl.Gain] $r, I G$ ★

Integral gain.

This parameter can be accessed if [PID Feedback] P, F is not set to [Not Configured] $n o$.

Setting ()	Description
0.01...100	Setting range Factory setting: 1

[PID derivative gain] $r, D G$ ★

Derivative gain.

This parameter can be accessed if [PID Feedback] P, F is not set to [Not Configured] $n o$.

Setting ()	Description
0.00...100	Setting range Factory setting: 0

[PID ramp] $P, r P$ ★

PID acceleration/deceleration ramp, defined to go from [Min PID reference] $P, P 1$ to [Max PID reference] $P, P 2$ and conversely.

This parameter can be accessed if [PID Feedback] P, F is not set to [Not Configured] $n o$.

Setting ()	Description
0...99.9 s	Setting range Factory setting: 0 s

[PID Inversion] P, I ★

PID inversion.

This parameter can be accessed if [PID Feedback] P, F is not set to [Not Configured] $n o$.

Setting	Code / Value	Description
[No]	$n o$	No Factory setting
[YES]	$y e s$	Yes

[PID Min Output] P_{oL} ★

PID controller minimum output in Hz.

This parameter can be accessed if **[PID Feedback] P_{iF}** is not set to **[Not Configured] n.o.**

Setting ()	Description
-500...500 Hz	Setting range Factory setting: 0 Hz

[PID Max Output] P_{oH} ★

PID controller maximum output in Hz.

This parameter can be accessed if **[PID Feedback] P_{iF}** is not set to **[Not Configured] n.o.**

Setting ()	Description
0...500 Hz	Setting range Factory setting: 60 Hz

[PID Error Warning] P_{eF} ★

PID error warning.

This parameter can be accessed if **[PID Feedback] P_{iF}** is not set to **[Not Configured] n.o.**

Setting ()	Description
0...65,535	Setting range Factory setting: 100

[PID Integral OFF] P_{iS} ★

Integral shunt.

If the assigned input or bit is at 0, the function is inactive (the PID integral is enabled).

If the assigned input or bit is at 1, the function is active (the PID integral is disabled).

This parameter can be accessed if **[PID Feedback] P_{iF}** is not set to **[Not Configured] n.o.**

Setting	Code / Value	Description
[Not Assigned]	n.o.	Not assigned Factory setting
[DI1]...[DI6]	L 1 / 1...L 1 6	Digital input DI1...DI6
[DI11]...[DI16]	L 1 1 / 1...L 1 1 6	Digital input DI11...DI16 if VW3A3203 I/O extension module has been inserted
[CD00]...[CD10]	C d 0 0...C d 1 0	Virtual digital input CMD.0...CMD.10 in [I/O profile] i.o configuration
[CD11]...[CD15]	C d 1 1...C d 1 5	Virtual digital input CMD.11...CMD.15 regardless of configuration
[C100]...[C110]	C 1 0 0...C 1 1 0	Virtual digital input CMD1.0...CMD1.10 with integrated Modbus Serial in [I/O profile] i.o configuration
[C111]...[C115]	C 1 1 1...C 1 1 5	Virtual digital input CMD1.11...CMD1.15 with integrated Modbus Serial regardless of configuration
[C300]...[C310]	C 3 0 0...C 3 1 0	Virtual digital input CMD3.0...CMD3.10 with a fieldbus module in [I/O profile] i.o configuration
[C311]...[C315]	C 3 1 1...C 3 1 5	Virtual digital input CMD3.11...CMD3.15 with a fieldbus module regardless of configuration

[PID acceleration time] ACCP ★

PID: acceleration during start-up.

PID start ramp can be applied before starting the PID controller to allow reaching quickly the PID reference without increasing PID gains. If configured, the **[Start Accel Ramp] ACCS** is applied up to **[Low Speed] LSP** instead of **[PID acceleration time] ACCP**.

This parameter can be accessed if **[PID Feedback] PIF** is not set to **[Not Configured] no**.

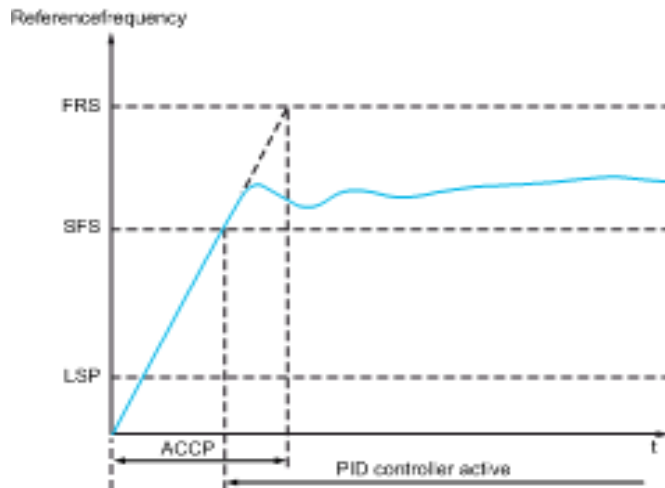

Setting ()	Description
0.01...99,99 s	Setting range Factory setting: 0.50 s
(1) Range 0.01 to 99.99 s or 0.1 to 999.9 s or 1 to 6,000 according to [Ramp increment] inc	

[PID Start Ref Freq] SFS ★

PID start reference frequency.

This parameter can be accessed if **[PID Feedback] PIF** is not set to **[Not Configured] no**.

Setting ()	Description
0.0...500.0 Hz	Setting range If [PID Start Ref Freq] SFS is lower than [Low speed] LSP , this function has no effect. Factory setting: 0.0 Hz

Section 6.11

[Generic functions] - [Sleep/wakeup]

What Is in This Section?

This section contains the following topics:

Topic	Page
[Sleep/Wakeup] <i>S P W</i> - Overview	189
[Sleep menu] <i>S L P</i> - Menu	192
[Sensor config. AI1] <i>S , F 1</i> - Menu	194
[Sensor config. AI2] <i>S , F 2</i> - Menu	196
[Sensor config. AI3] <i>S , F 3</i> - Menu	197
[Sensor config. AI4] <i>S , F 4</i> - Menu	198
[Sensor config. AI5] <i>S , F 5</i> - Menu	200
[DI5 sensor configuration] <i>S , F B</i> - Menu	201
[DI6 sensor configuration] <i>S , F 9</i> - Menu	202
[Sleep menu] <i>S L P</i> - Menu	203
[Boost] <i>S b t</i> - Menu	204
[Advanced sleep check] <i>A d S</i> - Menu	205
[Wake up menu] <i>w K P</i> - Menu	207

[Sleep/Wakeup] $5Pw$ - Overview

About This Menu

⚠ WARNING

UNANTICIPATED EQUIPMENT OPERATION

Verify that activating this function does not result in unsafe conditions.

Failure to follow these instructions can result in death, serious injury, or equipment damage.

The purpose of the "Sleep / Wake-Up" function is to stop the motor in process standstill situations.

It allows you to save energy and helps to prevent premature aging of some equipment that cannot run for a long time at low speed because the greasing or cooling depends on the machine speed.

In a pressure-controlled pumping application:

- The purpose of the Sleep / Wake-Up function is to manage periods of the application where the water demand is low and where it is not needed to keep the main pumps running.
- It allows you to save energy in low demand periods. Then, when the demand is increasing, the application needs to wake up in order to meet the demand.
- Optionally, during a sleep period, a Jockey pump can be started to maintain an emergency service pressure or meet a low water demand.

Depending on user-defined wakeup conditions, the motor is restarted automatically.

Sleep/Wake-Up in Speed Control Mode

The drive is in Speed control mode, when PID is not active, typically when:

- PID is not configured (the motor speed setpoint is controlled by an external PLC, for example).
- PID is in manual mode (manual protected application mode, for example).
- PID is not active because Channel 1 is not selected (forced local mode enabled, for example).

When the drive is used in Speed Control (PID not used or not active), a speed condition is used to switch the application to the sleep state. When the drive is in sleep state, the motor is restarted if the sleep condition disappears.

This function avoids prolonged operation at low speeds when neither useful nor compliant with the system constraints. It stops the motor after a period of operation at reduced speed. This time and speed can be adjusted.

In Speed control mode, Sleep/Wake-up is managed according to the following rules:

- The motor is stopped when $F_{r h}$ and $r F_{r}$ become and stay lower than $L S P + S L E$ during $t L S$.
- The motor is restarted when $F_{r h} > L S P + S L E$

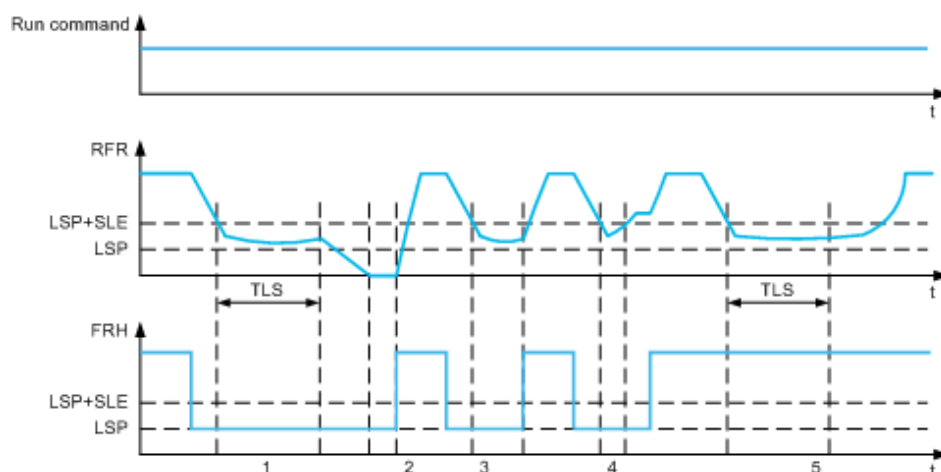

- 1 Nominal $t L S$ function action: after $t L S$ time, the motor is stopped according to the current deceleration ramp
- 2 $F_{r H}$ becomes greater than $L S P + S L E$ and run order still present $t L S$ function is deactivated
- 3 $t L S$ function is not activated because $F_{r H}$ becomes greater than $L S P + S L E$ before $t L S$ has expired
- 4 $t L S$ function is not activated because $r F_{r}$ becomes greater than $L S P + S L E$ before $t L S$ has expired
- 5 $t L S$ function is not activated because $F_{r H}$ stays greater than $L S P + S L E$

Sleep/Wake-Up in PID Control Mode

When the drive is used in PID control, one of the following conditions is used to switch the application to the sleep state:

- Sleep on low speed (when all fixed pumps are Off in case of a multi-pump application).
- Sleep on low sleep sensor value (using flow sensor for monitoring).
- Sleep on low motor power (when all fixed pumps are Off in case of a multi-pump application).
- Sleep on external condition (using drive input).

The drive is in "PID control mode" when PID is active. Typically when:

- PID is configured.
- And Channel 1 is selected.
- And PID is in automatic mode.

When the drive is in a sleep state, a wake-up condition is used to restart the application:

- Wake-up on PID Feedback level
- Wake-up on PID Error level

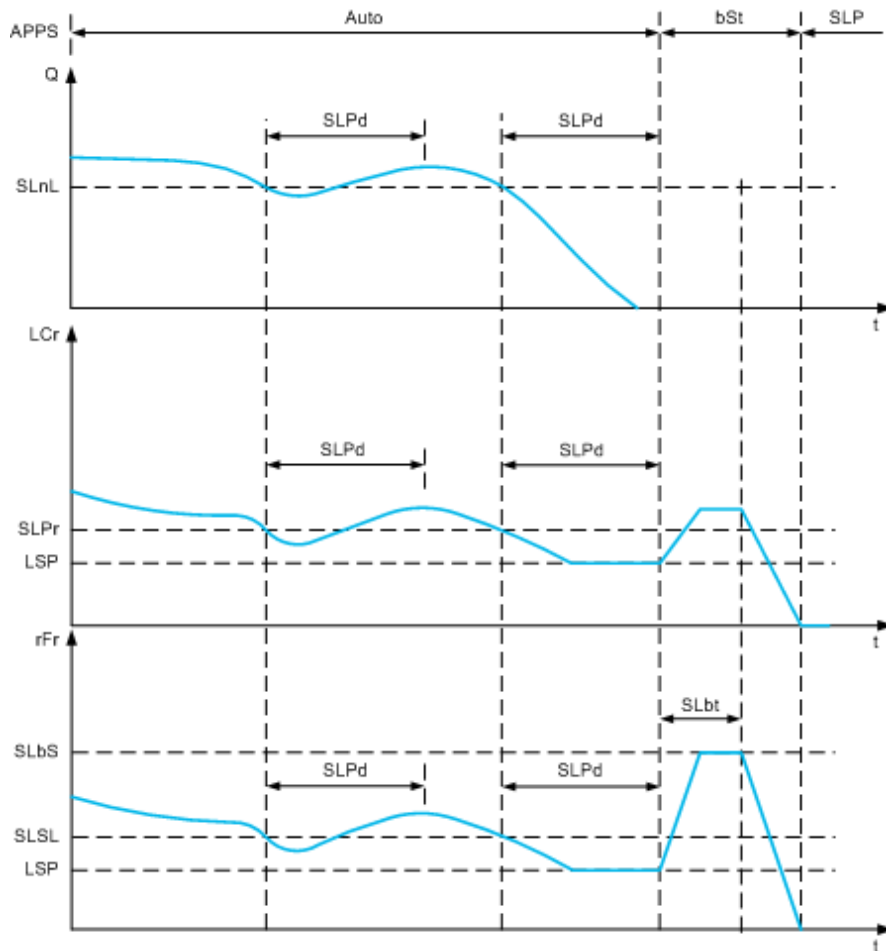

Sleep Conditions in PID Control Mode

If there is no valid wake-up condition, then the system switches to the sleep mode after one of the configured sleep conditions remains longer than **[Sleep Delay] SLPd**.

The sleep detection mode is selected by configuring **[Sleep Mode] ASLN**. Then the system switches to sleep mode if the selected condition is met:

Configuration	Condition
SnSr sleep on sensor value	[SLEEP_SENSOR_VALUE] is below [SLEEP_SENSOR_LEVEL]
Sw sleep on switch or external condition	[DI_SLEEP_SW] becomes active (activated when [SLEEP_SW] is configured)
SPd sleep on speed	[ACTUAL_VSD_SPEED] is below [SLEEP_SPEED] (activated when [SLEEP_SPEED] > 0) and all auxiliary pumps are stopped (in case of multi-pump system)
Pwr sleep on power level	[ACTUAL_MOT_POWER] is below [SLEEP_POWER] (activated when [SLEEP_POWER] > 0)

Wake-Up Conditions in PID Control Mode

The system wakes up according to **[WAKEUP_MODE]** configuration:

- On PID Feedback level.
- On PID Error level.

If Feedback Level is selected, then the system wakes up and goes back in PID control mode:

- When PID feedback drops below configured **[WAKEUP_PID_FEEDBACK]** if PID is configured in Direct mode (**[PI inversion]** is set to *n o*).
- When PID feedback raises above configured **[WAKEUP_PID_FEEDBACK]** if PID is configured in Reverse mode (**[PI inversion]** is set to *Y E S*).

If Error Level is selected, then the system wakes up and goes back in PID control mode:

- When PID feedback drops below (**[PID_REFERENCE]** - **[WAKEUP_PID_ERROR]**), if PID is configured in Direct mode (**[PI inversion]** is set to *n o*).
- When PID feedback raises above (**[PID_REFERENCE]** + **[WAKEUP_PID_ERROR]**), if PID is configured in Reverse mode (**[PI inversion]** is set to *Y E S*).

Boosting Phase in PID Control Mode

When entering the sleep mode, the motor accelerates to **[SLEEP_BOOST_SPEED]** during **[SLEEP_BOOST_TIME]** and then stops.

If **[SLEEP_BOOST_TIME]** is set to 0, then the boost phase is ignored.

Initial State in PID Control Mode

Just after a system start in automatic mode (a run order appears while in automatic mode - channel 1 already selected and PID auto):

- If a wake-up condition is met, the drive goes in control mode (PID started).
- If a wake-up condition is not met, the drive goes in sleep mode (PID stays stopped and motor is kept halted), and Boosting phase is ignored.

When the control is switched to automatic mode while the motor is running (switch to channel 1 or switch to PID auto mode for example), the drive stays in running state and switches to PID automatic mode.

Configuration of Sleep External Condition (Usage of a No Flow Switch for Example)

[SLEEP_SW] allows you to select the source of sleep external condition:

- *n o*: no input selected for the sleep external condition.
- *d i X*: the sleep external condition (switch for example) is connected to DIx (the assignment is also possible on a control bit in IO profile).

Configuration of Sleep Sensor (Flow Sensor)

The assignment of a sleep sensor, the configuration of the selected physical input and the configuration of scaling to process value are performed.

A sleep sensor source is selected by **SLEEP_SENSOR** which allows to select the analog or pulse input on which the sensor is connected:

- *n o*: no input selected for sleep sensor value.
- *A i X*: sleep sensor is connected to AIx.
- *P i X*: sleep sensor is connected to pulse input PIx.

The configuration of an analog input is performed.

The configuration of a pulse input is performed.

Depending on the selected source, the process range of the sensor is configured by:

- **[AIx_PROCESS_MIN]**, **[AIx_PROCESS_MAX]** (without unit), when connected on an analog input.
- **[PIx_PROCESS_MIN]**, **[PIx_PROCESS_MAX]** (without unit), when connected on a pulse input configured in frequency.

[Sleep menu] 5 L P - Menu

Access

[Complete settings] → [Generic functions] → [Sleep/Wakeup] → [Sleep menu]

About This Menu

[Sleep Detect Mode] 5 L P Π

Sleep detection mode.

Setting	Code / Value	Description
[No]	n o	Not configured Factory setting
[Switch]	5 W ?	System enters in sleep mode on switch condition
[Sensor]	5 n 5 r	System enters in sleep mode on sensor condition
[Speed]	5 P d	System enters in sleep mode on speed condition
[Power]	P W r	System enters in sleep mode on power condition

[Sleep Switch Assign] 5 L P W

Sleep switch assignment.

This parameter can be accessed if **[Sleep Detect Mode] 5 L P Π** is set to **[Switch] 5 W**.

Select an external condition to enter in sleep mode (for example, flow switch).

Setting	Code / Value	Description
[Not Assigned]	n o	Not assigned Factory setting
[DI1]...[DI6]	L , I ... L , I 6	Digital input DI1...DI6
[DI11]...[DI16]	L , I I I ... L , I 6	Digital input DI11...DI16 if VW3A3203 I/O extension module has been inserted
[CD00]...[CD10]	C d 0 0 ... C d 1 0	Virtual digital input CMD.0...CMD.10 in [I/O profile] , o configuration
[CD11]...[CD15]	C d 1 1 ... C d 1 5	Virtual digital input CMD.11...CMD.15 regardless of configuration
[C100]...[C110]	C 1 0 0 ... C 1 1 0	Virtual digital input CMD1.0...CMD1.10 with integrated Modbus Serial in [I/O profile] , o configuration
[C111]...[C115]	C 1 1 1 ... C 1 1 5	Virtual digital input CMD1.11...CMD1.15 with integrated Modbus Serial regardless of configuration
[C300]...[C310]	C 3 0 0 ... C 3 1 0	Virtual digital input CMD3.0...CMD3.10 with a fieldbus module in [I/O profile] , o configuration
[C311]...[C315]	C 3 1 1 ... C 3 1 5	Virtual digital input CMD3.11...CMD3.15 with a fieldbus module regardless of configuration
[DI1 (Low level)]...[DI6 (Low level)]	L I L ... L I 6 L	Digital input DI1...DI6 used at low level
[DI11 (Low level)]...[DI16 (Low level)]	L I I L ... L I 6 L	Digital input DI11...DI16 used at low level if VW3A3203 I/O extension module has been inserted

[Inst. Flow Assign.] F 5 I R ★

Installation flow sensor assignment.

This parameter can be accessed if **[Sleep Detect Mode] S L P F** is set to **[Sensor] S n S r**.

Setting	Code / Value	Description
[No]	n o	Not assigned Factory setting
[AI1]...[AI3]	R , 1...R , 3	Analog input AI1...AI3
[AI4]...[AI5]	R , 4...R , 5	Analog input AI4...AI5 if VW3A3203 I/O extension module has been inserted
[AI Virtual 1]	R , v 1	Virtual analogic input 1
[PulseInput Assignment On DI5]...[PulseInput Assignment On DI6]	P , 5...P , 6	Digital input DI5...DI6 used as pulse input
[Flow Estimation]	S L P F	Sensor less estimated flow

[Sensor config. AI1] 5 , F / - Menu

Access

[Complete settings] → [Generic functions] → [Sleep/wakeup] → [Sleep menu] → [Sensor config. AI1]

About This Menu

Following parameters can be accessed if

- [Sleep Switch Assign] 5 L PW is set to [Sensor] 5 n 5 r , and
- [Inst. Flow Assign.] F 5 / R is set to [AI1] R , / .

[AI1 Type] R , / E

Configuration of analog input AI1.

Setting	Code / Value	Description
[Voltage]	1 0 u	0-10 Vdc Factory setting
[Current]	0 R	0-20 mA

[AI1 min value] u , L / ★

AI1 voltage scaling parameter of 0%.

This parameter can be accessed if [AI1 Type] R , / E is set to [Voltage] 1 0 u .

Setting	Description
0.0...10.0 V	Setting range Factory setting: 0.0 V

[AI1 max value] u , H / ★

AI1 voltage scaling parameter of 100%.

This parameter can be accessed if [AI1 Type] R , / E is set to [Voltage] 1 0 u .

Setting	Description
0.0...10.0 V	Setting range Factory setting: 10.0 V

[AI1 min. value] C r L / ★

AI1 current scaling parameter of 0%.

This parameter can be accessed if [AI1 Type] R , / E is set to [Current] 0 R .

Setting	Description
0.0...20.0 mA	Setting range Factory setting: 0.0 mA

[AI1 max. value] C r H / ★

AI1 current scaling parameter of 100%.

This parameter can be accessed if [AI1 Type] R , / E is set to [Current] 0 R .

Setting	Description
0.0...20.0 mA	Setting range Factory setting: 20.0 mA

[A11 Lowest Process] R , I J

A11 lowest process.

Setting	Description
-32,768...32,767	Setting range Factory setting: 0

[A11 Highest Process] R , I K

A11 highest process.

Setting	Description
-32,768...32,767	Setting range Factory setting: 0

[Sensor config. AI2] 5 , F 2 - Menu

Access

[Complete settings] → [Generic functions] → [Sleep/wakeup] → [Sleep menu] → [Sensor config. AI2]

About this menu

Following parameters can be accessed if:

- [Sleep Switch Assign] 5 L P W is set to [Sensor] 5 n 5 r , and
- [Inst. Flow Assign.] F 5 I R is set to [AI2] R , 2 .

[AI2 Type] R , 2 E

Configuration of analog input AI2.

Setting	Code / Value	Description
[Voltage]	I D U	0-10 Vdc
[Current]	D R	0-20 mA Factory setting
[PTC Management]	P E C	1 to 6 PTC (in serial)
[KTY]	K E Y	1 KTY84
[PT1000]	I P E 3	1 PT1000 connected with 2 wires
[PT100]	I P E 2	1 PT100 connected with 2 wires
[Water Prob]	L E U E L	Water level
[3PT1000]	3 P E 3	3 PT1000 connected with 2 wires
[3PT100]	3 P E 2	3 PT100 connected with 2 wires

[AI2 min value] U , L 2 ★

AI2 voltage scaling parameter of 0%.

This parameter can be accessed if [AI2 Type] R , 2 E is set to [Voltage] I D U .

Identical to [AI1 min value] U , L 1 (see page 194).

[AI2 max value] U , H 2 ★

AI2 voltage scaling parameter of 100%.

This parameter can be accessed if [AI2 Type] R , 2 E is set to [Voltage] I D U .

Identical to [AI1 max value] U , H 1 (see page 194).

[AI2 min. value] C r L 2 ★

AI2 current scaling parameter of 0%.

This parameter can be accessed if [AI2 Type] R , 2 E is set to [Current] D R .

Identical to [AI1 min. value] C r L 1 (see page 194) with factory setting: 0.4 mA.

[AI2 max. value] C r H 2 ★

AI2 current scaling parameter of 100%.

This parameter can be accessed if [AI2 Type] R , 2 E is set to [Current] D R .

Identical to [AI1 max. value] C r H 1 (see page 194).

[AI2 Lowest Process] R , 2 J

AI2 lowest process.

Identical to [AI1 Lowest Process] R , 1 J (see page 195).

[AI2 Highest Process] R , 2 K

AI2 highest process.

Identical to [AI1 Highest Process] R , 1 K (see page 195).

[Sensor config. AI3] 5 , F 3 - Menu

Access

[Complete settings] → [Generic functions] → [Sleep/wakeup] → [Sleep menu] → [Sensor config. AI3]

About this menu

Following parameters can be accessed if:

- [Sleep Switch Assign] 5 L PW is set to [Sensor] 5 n 5 r , and
- [Inst. Flow Assign.] F 5 I R is set to [AI3] R , 3 .

[AI3 Type] R , 3 E

Configuration of analog input AI3.

Identical to [AI2 Type] R , 2 E (see page 196).

[AI3 min value] 0 , L 3 ★

AI3 voltage scaling parameter of 0%.

This parameter can be accessed if R , 3 E is set to [Voltage] I 0 0 .

Identical to [AI1 min value] 0 , L 1 (see page 194).

[AI3 max value] 0 , H 3 ★

AI3 voltage scaling parameter of 100%.

This parameter can be accessed if R , 3 E is set to [Voltage] I 0 0 .

Identical to [AI1 max value] 0 , H 1 (see page 194).

[AI3 min. value] C r L 3 ★

AI3 current scaling parameter of 0%.

This parameter can be accessed if R , 3 E is set to [Current] 0 R .

Identical to [AI1 min. value] C r L 1 (see page 194).

[AI3 max. value] C r H 3 ★

AI3 current scaling parameter of 100%.

This parameter can be accessed if R , 3 E is set to [Current] 0 R .

Identical to [AI1 max. value] C r H 1 (see page 194).

[AI3 Lowest Process] R , 3 J

AI3 lowest process.

Identical to [AI1 Lowest Process] R , 1 J (see page 195).

[AI3 Highest Process] R , 3 K

AI3 highest process.

Identical to [AI1 Highest Process] R , 1 K (see page 195).

[Sensor config. AI4] 5 , F 4 - Menu

Access

[Complete settings] → [Pump functions] → [Sleep/wakeup] → [Sleep menu] → [Sensor config. AI4]

About this menu

Following parameters can be accessed if

- [Sleep Switch Assign] 5 L P W is set to [Sensor] 5 n 5 r ,
- VW3A3203 I/O extension module has been inserted, and
- [Inst. Flow Assign.] F 5 I R is set to [AI4] R , 4 .

[AI4 Type] R , 4 L ★

Configuration of analog input AI4.

This parameter can be accessed if VW3A3203 I/O extension module has been inserted.

Setting	Code / Value	Description
[Voltage]	I 0 u	0-10 Vdc
[Current]	0 R	0-20 mA
[Voltage +/-]	n I 0 u	-10/+10 Vdc Factory setting
[PTC Management]	P E C	1 to 6 PTC (in serial)
[KTY]	K E Y	1 KTY84
[PT1000]	I P E 3	1 PT1000 connected with 2 wires
[PT100]	I P E 2	1 PT100 connected with 2 wires
[3 PT1000]	3 P E 3	3 PT1000 connected with 2 wires
[3 PT100]	3 P E 2	3 PT100 connected with 2 wires
[PT1000 in 3 wires]	I P E 3 3	1 PT1000 connected with 3 wires (AI4 & AI5 only)
[PT100 in 3 wires]	I P E 2 3	1 PT100 connected with 3 wires (AI4 & AI5 only)
[3 PT1000 in 3 wires]	3 P E 3 3	3 PT1000 connected with 3 wires (AI4 & AI5 only)
[3 PT100 in 3 wires]	3 P E 2 3	3 PT100 connected with 3 wires (AI4 & AI5 only)

[AI4 min value] u , L 4 ★

AI4 voltage scaling parameter of 0%.

Identical to [AI1 min value] u , L 1 (see page 194).

[AI4 max value] u , H 4 ★

AI4 voltage scaling parameter of 100%.

Identical to [AI1 max value] u , H 1 (see page 194).

[AI4 min. value] C r L 4 ★

AI4 current scaling parameter of 0%.

Identical to [AI1 min. value] C r L 1 (see page 194).

[AI4 max. value] C r H 4 ★

AI4 current scaling parameter of 100%.

Identical to [AI1 max. value] C r H 1 (see page 194).

[AI4 Lowest Process] R , 4 J

AI4 lowest process.

Identical to **[AI1 Lowest Process] R , 1 J** (*see page 195*).

[AI4 Highest Process] R , 4 K

AI4 highest process.

Identical to **[AI1 Highest Process] R , 1 K** (*see page 195*).

[Sensor config. AI5] 5 , F 5 - Menu

Access

[Complete settings] → [Generic functions] → [Sleep/wakeup] → [Sleep menu] → [Sensor config. AI5]

About this menu

Following parameters can be accessed if

- [Sleep Switch Assign] 5 L Pw is set to [Sensor] 5 n 5 r ,
- VW3A3203 I/O extension module has been inserted, and
- [Inst. Flow Assign.] F 5 I R is set to [AI5] R , 5 .

[AI5 Type] R , 5 L ★

Configuration of analog input AI5.

This parameter can be accessed if VW3A3203 relay output option module has been inserted.

Identical to [AI4 Type] R , 4 L (see page 198).

[AI5 min value] u , L 5 ★

AI5 voltage scaling parameter of 0%.

Identical to [AI1 min value] u , L 1 (see page 194).

[AI5 max value] u , H 5 ★

AI5 voltage scaling parameter of 100%.

Identical to [AI1 max value] u , H 1 (see page 194).

[AI5 min. value] C r L 5 ★

AI5 current scaling parameter of 0%.

Identical to [AI1 min. value] C r L 1 (see page 194).

[AI5 max. value] C r H 5 ★

AI5 current scaling parameter of 100%.

Identical to [AI1 max. value] C r H 1 (see page 194).

[AI5 Lowest Process] R , 5 J

AI5 lowest process.

Identical to [AI1 Lowest Process] R , 1 J (see page 195).

[AI5 Highest Process] R , 5 K

AI5 highest process.

Identical to [AI1 Highest Process] R , 1 K (see page 195).

[DI5 sensor configuration] *S , F B* - Menu

Access

[Complete settings] → [Generic functions] → [Sleep/wakeup] → [Sleep menu] → [DI5 sensor configuration]

About This Menu

Following parameters can be accessed if [Sleep Switch Assign] *S L Pw* is set to [Sensor] *S n S r* and [Inst. Flow Assign.] *F S I R* is set to [PI5] *P , S*.

[PulseInput DI5 Low Freq] *P , L S*

Pulse input DI5 low frequency.

Setting	Description
0.00...30,000.00 Hz	Setting range Factory setting: 0.00 Hz

[PulseInput DI5 High Freq] *P , H S*

Pulse input DI5 high frequency.

Setting	Description
0.00...30.00 kHz	Setting range Factory setting: 30.00 kHz

[DI5 Min Process] *P , S J*

Minimum process value for selected input.

Setting	Description
-32,768...32,767	Setting range Factory setting: 0

[DI5 Max Process] *P , S K*

Maximum process value for selected input.

Setting	Description
-32,768...32,767	Setting range Factory setting: 0

[DI6 sensor configuration] 5 , F 9 - Menu

Access

[Complete settings] → [Generic functions] → [Sleep/wakeup] → [Sleep menu] → [DI6 sensor configuration]

About This Menu

Identical to [DI5 sensor configuration] 5 , F 8 - Menu (*see page 201*).

Following parameters can be accessed if [Sleep Switch Assign] 5 L P W is set to [Sensor] 5 n 5 r and [Inst. Flow Assign.] F 5 I R is set to [PI6] P , 6 .

[PulseInput DI6 Low Freq] P , L 6

Pulse input DI6 low frequency.

[PulseInput DI6 High Freq] P , H 6

Pulse input DI6 high frequency.

[DI6 Min Process] P , 6 J

Minimum process value for selected input.

[DI6 Max Process] P , 6 K

Maximum process value for selected input.

[Sleep menu] 5 L P - Menu**Access**

[Complete settings] → [Generic functions] → [Sleep/wakeup] → [Sleep menu]

[Sleep Flow Level] 5 L n L ★

Sleep flow level.

Sensor level under which the system should enter the sleep mode (Zero value to deactivate).

This parameter can be accessed if

- [Sleep Switch Assign] 5 L P W is set to [Sensor] 5 n S r , and
- [Inst. Flow Assign.] F 5 I R is not set to [Not Configured] n o .

Setting ()	Description
[No] n o to 32,767	Setting range Unit: [Flow rate unit] 5 u F r (e.g. %, l/s; m3/h) Factory setting: [No] n o

[Sleep Min Speed] 5 L 5 L ★

Sleep flow level.

Speed level under which the system should enter the sleep mode.

This parameter can be accessed if [Sleep Detect Mode] 5 L P Π is set to [Speed] 5 P d .

Setting ()	Description
0...500.0 Hz	Setting range Factory setting: [No] n o

[Sleep Power Level] 5 L P r ★

Sleep power level.

Power level under which the system should enter the sleep mode.

This parameter can be accessed if [Sleep Detect Mode] 5 L P Π is set to [Power] P W r .

Setting ()	Description
0...[Nominal Motor Power] n P r	Setting range Factory setting: [No] n o

[Sleep Delay] 5 L P d ★

Sleep delay.

This parameter can be accessed if [Sleep Detect Mode] 5 L P Π is not set to [Not Configured] n o .

Setting ()	Description
0...3,600 s	Setting range Factory setting: 20 s

[Boost] 5 b t - Menu**Access**

[Complete settings] → [Generic functions] → [Sleep/wakeup] → [Sleep menu] → [Boost]

About This Menu

Following parameters can be accessed if [Sleep Detect Mode] 5 L P 1 is not set to [No] n a.

[Sleep Boost Speed] 5 L b 5 ★

Sleep boost speed.

Setting ()	Description
0...500.0 Hz	Setting range Factory setting: n a

[Sleep Boost Time] 5 L b t ★

Sleep boost time.

This parameter can be accessed if [Sleep Boost Speed] 5 L b 5 is not set to 0.

Setting ()	Description
0...3,600 s	Setting range Factory setting: n a

[Advanced sleep check] *AdS* - Menu

Access

[Complete settings] → [Generic functions] → [Sleep/wakeup] → [Sleep menu] → [Advanced sleep check]

About This Menu

This function can be activated if [Type of control] *LoCt* is set to [Speed] *SPd* or [Power] *PWr*.

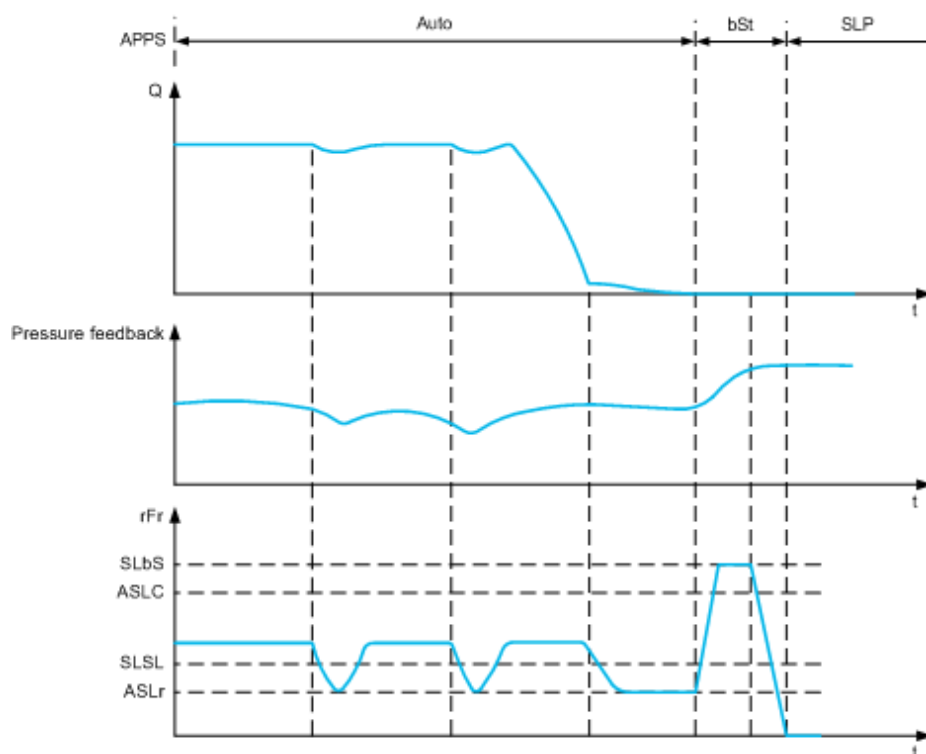
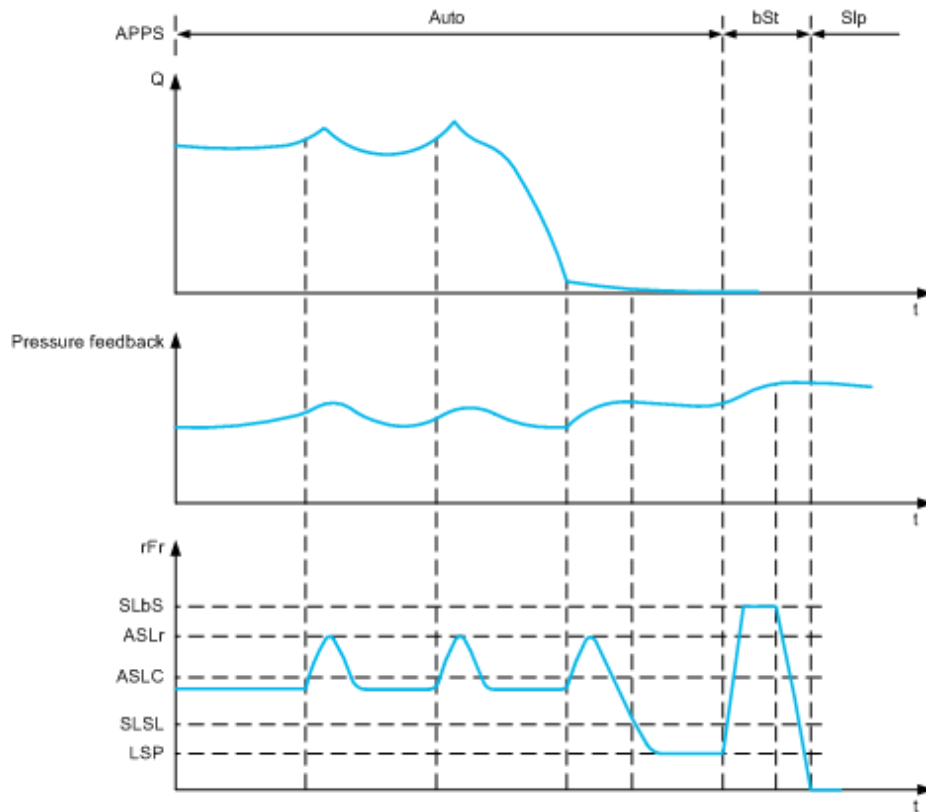

[Sleep Mode] # 5 L Π

Advanced sleep mode.

Setting ()	Code / Value	Description
[No]	<i>n o</i>	No Factory setting
[YES]	<i>y e s</i>	Yes

[Sleep Condition] # 5 L C ★

Advanced sleep verifies speed condition.

This parameter can be accessed if **[Sleep Mode] # 5 L Π** is not set to **[No] n o**.

Setting ()	Description
0...[High Speed] <i>H 5 P</i>	Setting range Factory setting: 0.0 Hz

[Sleep Delay] # 5 L d ★

Advanced sleep verifies delay.

This parameter can be accessed if **[Sleep Mode] # 5 L Π** is not set to **[No] n o**.

Setting ()	Description
0...9,999 s	Setting range Factory setting: 20 s

[Check Sleep Ref Spd] # 5 L r ★

Advanced sleep verifies speed reference.

This parameter can be accessed if **[Sleep Mode] # 5 L Π** is not set to **[No] n o**.

Setting ()	Description
0...[High Speed] <i>H 5 P</i>	Setting range Factory setting: 0.0 Hz

[Wake up menu] *W K P* - Menu

Access

[Complete settings] → [Generic functions] → [Sleep/wakeup] → [Wake up menu]

About This Menu

Following parameters can be accessed if [Sleep Detect Mode] *S L P D* is not set to [Not Configured] *n o*.

[Wake Up Mode] *W U P M* ★

Wake-up mode.

Setting	Code / Value	Description
[Feedback]	<i>F b K</i>	Wake-Up on PID feedback level Factory setting
[Error]	<i>E r r</i>	Wake-Up on PID error level

[Wake Up Press Level] *W U P F* ★

Wake-up pressure level.

This parameter can be accessed if [Wake Up Mode] *W U P M* is set to [Feedback] *F b K*.

Setting ()	Description
[Min PID feedback] <i>P , F 1</i> ...[Max PID feedback] <i>P , F 2</i>	Setting range Factory setting: 0

[WUP Press. Error] *W U P E* ★

Wake-up pressure error level.

This parameter can be accessed if [Wake Up Mode] *W U P M* is set to [Error] *E r r*.

Setting ()	Description
0...[Max PID feedback] <i>P , F 2</i>	Setting range Factory setting: 0,0 Hz

Section 6.12

[Generic functions] - [Feedback monitoring]

[Feedback monitoring] F K Π - Menu

Access

[Complete settings] → [Generic functions] → [Feedback monitoring]

About This Menu

The function is typically used to detect cases where the installation capability is exceeded or where the installation is not operating properly:

- Fire hydrant opened.
- Pump start-up with open discharge valve.
- Mechanical breakdown of pipes.
- Water leakage.

When the drive is running at high speed, this function monitors the PID feedback in order to detect if it is out of a given range around the setpoint during a configurable time.

By means of a warning or a detected error, this function also indicates that:

- The capability of the installation is exceeded
- The proper control could not be ensured
- Something is wrong on the installation.

This graphic presents the PID feedback monitoring:

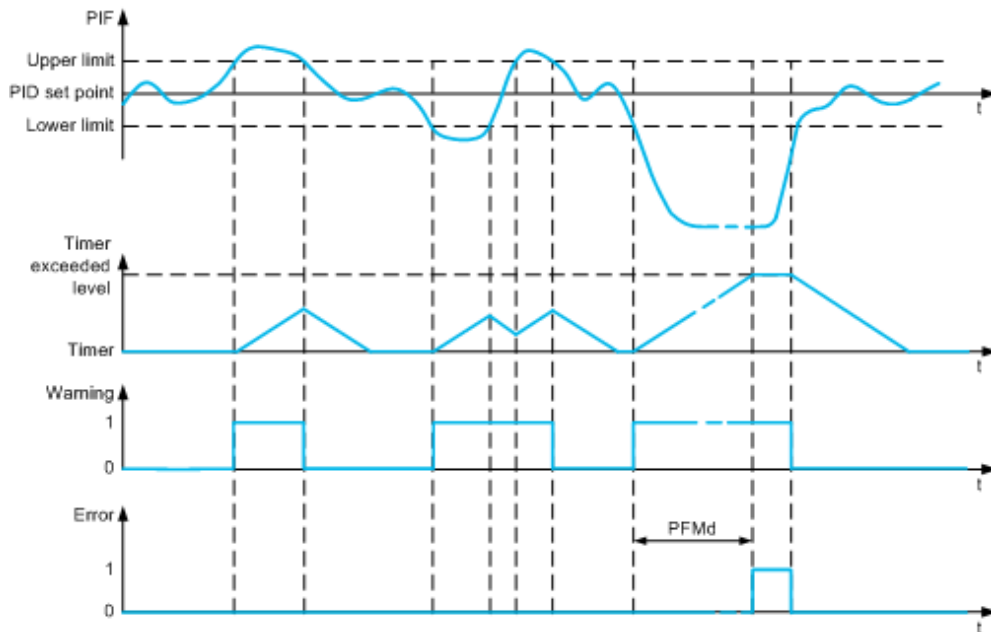

[PID Fdbk Monitoring] P F Π Π

PID feedback monitoring mode.

Parameter used to activate the function.

Setting	Code / Value	Description
[No]	n o	No Factory setting
[YES]	y e s	Yes

[PID Fdbk Range] P F Π r ★

PID feedback monitoring range.

Range within which the PID feedback value is supposed to stay in normal situation.

This parameter can be accessed if **[PID Fdbk Monitoring] P F Π Π** is not set to **[No] n o**.

Setting ()	Description
0...100%	Setting range Factory setting: 3%

[PID Fdbk Error Delay] P F Π d ★

PID feedback monitoring delay.

Delay to trig an error after detection of an anomaly.

This parameter can be accessed if **[PID Fdbk Monitoring] P F Π Π** is not set to **[No] n o**.

Setting ()	Description
0...3,600 s	Setting range Factory setting: 10 s

[PID Fdbk Error Resp] P F Π b ★

PID feedback monitoring response to a detected error.

Define how the drive reacts when a feedback monitoring error occurs.

This parameter can be accessed if **[PID Fdbk Monitoring] P F Π Π** is not set to **[No] n o**.

Setting	Code / Value	Description
[Ignore]	<i>n o</i>	Detected error ignored
[Freewheel Stop]	<i>Y E S</i>	Freewheel stop
[Per STT]	<i>S E E</i>	Stop according to [Type of stop] S E E parameter but without an error triggered after stop
[Fallback Speed]	<i>L F F</i>	Change to fallback speed, maintained as long as the detected error persists and the run command has not been removed ⁽¹⁾
[Ramp stop]	<i>r Π P</i>	Stop on ramp Factory setting
1 Because, in this case, the detected error does not trigger a stop, it is recommended to assign a relay or logic output to its indication.		

Section 6.13

[Generic functions] - [Threshold reached]

[Threshold reached] *E H r E* - Menu

Access

[Complete settings] → [Generic functions] → [Threshold reached]

[Low I Threshold] *C E d L*

Current low threshold value.

Setting ()	Description
0...65,535 A	Setting range Factory setting: 0 A

[High Current Thd] *C E d*

Current high threshold value.

Setting ()	Description
0...65,535 A	Setting range Factory setting: Drive nominal current

[Low Freq. Threshold] *F E d L*

Motor low frequency threshold.

Setting ()	Description
0.0...500.0 Hz	Setting range Factory setting: 0.0 Hz

[Motor Freq Thd] *F E d*

Motor frequency threshold.

Setting ()	Description
0.0...500.0 Hz	Setting range Factory setting: 50.0 Hz

[2 Freq. Threshold] *F 2 d L*

Motor low frequency second threshold.

Setting ()	Description
0.0...500.0 Hz	Setting range Factory setting: 0.0 Hz

[Freq. threshold 2] *F 2 d*

Motor frequency threshold 2.

Setting ()	Description
0.0...500.0 Hz	Setting range Factory setting: 50.0 Hz

[Motor Thermal Thd] *LTd*

Motor thermal state threshold.

Setting 	Description
0...118%	Setting range Factory setting: 100%

[Reference high Thd] *rLTd*

Reference frequency high threshold.

Setting 	Description
0.0...500.0 Hz	Setting range Factory setting: 0.0 Hz

[Reference low Thd] *rLTdL*

Reference low threshold.

Setting 	Description
0.0...500.0 Hz	Setting range Factory setting: 0.0 Hz

Section 6.14

[Generic functions] - [Mains contactor command]

[Mains contactor command] L L C - Menu

Access

[Complete settings] → [Generic functions] → [Mains contactor command]

About This Menu

The line contactor closes every time a run command (forward or reverse) is sent and opens after every stop, as soon as the drive is locked. For example, if the stop mode is stop on ramp, the contactor opens when the motor reaches zero speed.

NOTE: The drive control power supply must be provided via an external 24 Vdc source.

NOTICE

DAMAGE TO THE DRIVE

This function must not be activated with a cycle shorter than 60 s.

Failure to follow these instructions can result in equipment damage.

Example circuit (24 Vdc power supply):

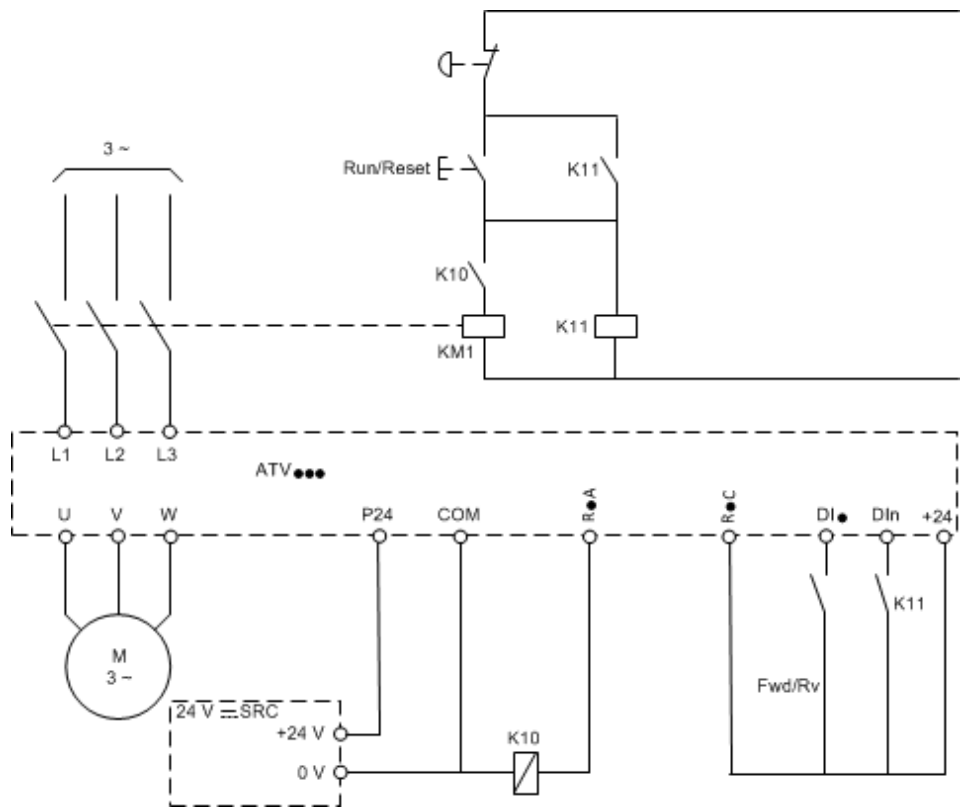

DI = Run command [Forward] Fwd or [Reverse] Rev

R/A/R/C = [Mains Contactor] L L C

DIIn = [Drive Lock] L E 5

NOTE: The Run/Reset key must be pressed once the emergency stop key has been released.

[Mains Contactor] L L C

Mains contactor control.

Setting	Code / Value	Description
[No]	<i>n o</i>	Not assigned Factory setting
[R2]...[R3]	<i>r 2...r 3</i>	Relay output R2...R3
[R4]...[R6]	<i>r 4...r 6</i>	Relay output R4...R5 if VW3A3204 relay output option module has been inserted
[Analog output DQ11]...[Analog output DQ12]	<i>d o 1 1...d o 1 2</i>	Analog / digital output DO11...DO12 if VW3A3203 I/O extension module has been inserted

[Drive Lock] L E 5 ★

Drive lock assignment.

This parameter can be accessed if **[Mains Contactor] L L C** is not set to **[No] n o**.

Setting	Code / Value	Description
[Not Assigned]	<i>n o</i>	Not assigned Factory setting
[DI1]...[DI6]	<i>L , 1...L , 6</i>	Digital input DI1...DI6
[DI11]...[DI16]	<i>L , 1 1...L , 1 6</i>	Digital input DI11...DI16 if VW3A3203 I/O extension module has been inserted
[CD00]...[CD10]	<i>C d 0 0...C d 1 0</i>	Virtual digital input CMD.0...CMD.10 in [I/O profile] , o configuration
[CD11]...[CD15]	<i>C d 1 1...C d 1 5</i>	Virtual digital input CMD.11...CMD.15 regardless of configuration
[C100]...[C110]	<i>C 1 0 0...C 1 1 0</i>	Virtual digital input CMD1.0...CMD1.10 with integrated Modbus Serial in [I/O profile] , o configuration
[C111]...[C115]	<i>C 1 1 1...C 1 1 5</i>	Virtual digital input CMD1.11...CMD1.15 with integrated Modbus Serial regardless of configuration
[C300]...[C310]	<i>C 3 0 0...C 3 1 0</i>	Virtual digital input CMD3.0...CMD3.10 with a fieldbus module in [I/O profile] , o configuration
[C311]...[C315]	<i>C 3 1 1...C 3 1 5</i>	Virtual digital input CMD3.11...CMD3.15 with a fieldbus module regardless of configuration

[Mains V. time out] L C E ★

Monitoring time for closing of line contactor.

This parameter can be accessed if **[Mains Contactor] L L C** is not set to **[No] n o**.

Setting	Description
5...999 s	Setting range Factory setting: 5 s

Section 6.15

[Generic functions] - [Parameters switching]

What Is in This Section?

This section contains the following topics:

Topic	Page
[Parameters switching] <i>PLP</i> - Menu	215
[Set 1] <i>P51</i> - Menu	218
[Set 2] <i>P52</i> - Menu	219
[Set 3] <i>P53</i> - Menu	220

[Parameters switching] *PLP* - Menu

Access

[Complete settings] → [Generic functions] → [Parameters switching]

About This Menu

A set of 1 to 15 parameters from the [PARAMETER SELECTION] *SP5* list (see page 216) can be selected and 2 or 3 different values assigned. These 2 or 3 sets of values can then be switched using 1 or 2 digital inputs or control word bits. This switching can be performed during operation (motor running). It can also be controlled based on 1 or 2 frequency thresholds, whereby each threshold acts as a digital input (0 = threshold not reached, 1 = threshold reached).

	Values 1	Values 2	Values 3
Parameter 1 ... Parameter 15	Parameter 1 ... Parameter 15	Parameter 1 ... Parameter 15	Parameter 1 ... Parameter 15
Input DI or bit or frequency threshold 2 values	0	1	0 or 1
Input DI or bit or frequency threshold 3 values	0	0	1

NOTE: Do not modify the parameters in [PARAMETER SELECTION] *SP5* (see page 216), because any modifications made in this menu will be lost on the next power-up. The parameters can be adjusted during operation in the [Parameters switching] *PLP* - menu, on the active configuration.

[2 Parameter sets] *CHRI*

Parameter switching assignment 1.

Setting	Code / Value	Description
[Not assigned]	<i>no</i>	Not assigned Factory setting
[Motor Freq High Thd]	<i>FtR</i>	Motor frequency high threshold reached
[2nd Frequency Thd Reached]	<i>F2R</i>	2nd frequency threshold reached
[DI1]...[DI6]	<i>L, I...L, B</i>	Digital input DI1...DI6
[DI11]...[DI16]	<i>L, I I...L, IB</i>	Digital input DI11...DI16 if VW3A3203 I/O extension module has been inserted
[CD00]...[CD10]	<i>CdD0...CdID</i>	Virtual digital input CMD.0...CMD.10 in [I/O profile] <i>no</i> configuration
[CD11]...[CD15]	<i>CdI I...CdIS</i>	Virtual digital input CMD.11...CMD.15 regardless of configuration
[C100]...[C110]	<i>CID0...CIID</i>	Virtual digital input CMD1.0...CMD1.10 with integrated Modbus Serial in [I/O profile] <i>no</i> configuration
[C111]...[C115]	<i>CII I...CIIS</i>	Virtual digital input CMD1.11...CMD1.15 with integrated Modbus Serial regardless of configuration
[C300]...[C310]	<i>C3D0...C3ID</i>	Virtual digital input CMD3.0...CMD3.10 with a fieldbus module in [I/O profile] <i>no</i> configuration
[C311]...[C315]	<i>C3I I...C3IS</i>	Virtual digital input CMD3.11...CMD3.15 with a fieldbus module regardless of configuration

[3 Parameter sets] *CHR2*

Parameter switching assignment 2.

Identical to [2 Parameter sets] *CHRI*.

Switching 3 parameter sets.

NOTE: In order to obtain 3 parameter sets, it is necessary to configure first [2 Parameter sets] *CHRI*.

[PARAMETER SELECTION] 5 P 5

This parameter can be accessed if **[2 Parameter sets] C H R 1** is not set to **[No] n o**.

Making an entry in this parameter opens a window containing all the adjustment parameters that can be accessed. Select 1 to 15 parameters using **OK** key. Parameter(s) can also be deselected using **OK** key.

Available parameters for parameters switching function are:

Parameter	Code
[Ramp increment]	<i>i n r</i>
[Acceleration]	<i>A C C</i>
[Deceleration]	<i>d E C</i>
[Acceleration 2]	<i>A C 2</i>
[Deceleration 2]	<i>d E 2</i>
[Begin Acc round]	<i>t A 1</i>
[End Acc round]	<i>t A 2</i>
[Begin Dec round]	<i>t A 3</i>
[End Dec round]	<i>t A 4</i>
[Low Speed]	<i>L S P</i>
[High Speed]	<i>H S P</i>
[Motor Th Current]	<i>i t H</i>
[IR compensation]	<i>u F r</i>
[Slip compensation]	<i>S L P</i>
[K speed loop filter]	<i>S F C</i>
[Speed time integral]	<i>S i t</i>
[Speed prop. gain]	<i>S P G</i>
[Inertia Factor]	<i>S P G u</i>
[Ramp Divider]	<i>d C F</i>
[DC Inj Level 1]	<i>i d C</i>
[DC Inj Time 1]	<i>t d i</i>
[DC Inj Level 2]	<i>i d C 2</i>
[DC Inj Time 2]	<i>t d C</i>
[Auto DC inj Level 1]	<i>S d C 1</i>
[Auto DC Inj Time 1]	<i>t d C 1</i>
[Auto DC inj Level 2]	<i>S d C 2</i>
[Auto DC Inj Time 2]	<i>t d C 2</i>
[Switching frequency]	<i>S F r</i>
[Current Limitation]	<i>C L i</i>
[Low Speed Timeout]	<i>t L S</i>
[Sleep Offset Thres.]	<i>S L E</i>
[Preset speed 2]...[Preset speed 8]	<i>S P 2... S P 8</i>
[PID Prop.Gain]	<i>r P G</i>
[PID Intgl.Gain]	<i>r i G</i>
[PID derivative gain]	<i>r d G</i>
[PID ramp]	<i>P r P</i>
[PID Min Output]	<i>P o L</i>
[PID acceleration time]	<i>A C C P</i>
[Min fbk Warning]	<i>P A L</i>
[Max fbk Warning]	<i>P A H</i>
[PID error Warning]	<i>P E r</i>
[Speed input %]	<i>P S r</i>
[Ref PID Preset 2]	<i>r P 2</i>
[Ref PID Preset 3]	<i>r P 3</i>
[Ref PID Preset 4]	<i>r P 4</i>

Parameter	Code
[PID Fdbk Range]	<i>P F Π r</i>
[PID Fdbk Error Delay]	<i>P F Π d</i>
[High Current Thd]	<i>C t d</i>
[Low I Threshold]	<i>C t d L</i>
[High torque thd.]	<i>t t H</i>
[Low torque thd.]	<i>t t L</i>
[Motor Freq Thd]	<i>F t d</i>
[Low Freq.Threshold]	<i>F t d L</i>
[Freq. threshold 2]	<i>F 2 d</i>
[2 Freq. Threshold]	<i>F 2 d L</i>
[Freewheel stop Thd]	<i>F F t</i>
[Motor Therm Thd]	<i>t t d</i>
[Reference high Thd]	<i>r t d</i>
[Reference low Thd]	<i>r t d L</i>
[Skip Frequency]	<i>J P F</i>
[Skip Frequency 2]	<i>J F 2</i>
[3rd Skip Frequency]	<i>J F 3</i>
[Skip Freq.Hysteresis]	<i>J F H</i>
[Unld.Thr.Nom.Speed]	<i>L u n</i>
[Unld.Thr.0.Speed]	<i>L u L</i>
[Unld. FreqThr. Det.]	<i>r Π u d</i>
[Hysteresis Freq]	<i>S r b</i>
[Underload T.B.Rest.]	<i>F t u</i>
[Ovld Detection Thr.]	<i>L o C</i>
[Overload T.B.Rest.]	<i>F t o</i>
[Fan mode]	<i>F F Π</i>
[Stall Max Time]	<i>S t P 1</i>
[Stall Current]	<i>S t P 2</i>
[Stall Frequency]	<i>S t P 3</i>
[AI2 Th Warn Level]	<i>t H 2 R</i>
[AI5 Th Warn Level]	<i>t H 5 R</i>
[AI2 Th Error Level]	<i>t H 2 F</i>
[AI5 Th Error Level]	<i>t H 5 F</i>
[Sleep Min Speed]	<i>S L S L</i>
[Sleep Delay]	<i>S L P d</i>
[Sleep Boost Speed]	<i>S L b S</i>
[Sleep Boost Time]	<i>S L b t</i>
[Sleep Condition]	<i>A S L C</i>
[Sleep Check Delay]	<i>A S L d</i>
[Check Sleep Ref spd]	<i>A S L r</i>

[Set 1] P 5 / - Menu

Access

[Complete settings] → [Generic functions] → [Parameters switching] → [Set 1]

About This Menu

Making an entry in this menu opens a settings window containing the selected parameters in the order in which they were selected.

[Set 2] P 5 2 - Menu

Access

[Complete settings] → [Generic functions] → [Parameters switching] → [Set 2]

About This Menu

Identical to [Set 1] P 5 1 - ([see page 219](#)).

[Set 3] P 5 3 - Menu

Access

[Complete settings] → [Generic functions] → [Parameters switching] → [Set 3]

About This Menu

Identical to [Set 1] P 5 1 - ([see page 219](#)).

Section 6.16

[Generic functions] - [Stop on prolonged spd]

[Stop after speed timeout] $P_r 5 P$ - Menu

Access

[Complete settings] → [Generic functions] → [Stop after speed timeout]

Sleep/Wake-Up in Speed Control Mode

The drive is in Speed control mode, when PID is not active, typically when:

- PID is not configured (the motor speed setpoint is controlled by an external PLC, for example).
- PID is in manual mode (manual application mode, for example).
- PID is not active because Channel 1 is not selected (forced local mode enabled, for example).

When the drive is used in Speed Control (PID not used or not active), a speed condition is used to switch the application to the sleep state. When the drive is in sleep state, the motor is restarted if the sleep condition disappears.

This function avoids prolonged operation at low speeds when neither useful nor compliant with the system constraints. It stops the motor after a period of operation at reduced speed. This time and speed can be adjusted.

In Speed control mode, Sleep/Wake-up is managed according to the following rules:

- The motor is stopped when [Pre-Ramp Ref Freq] $F_r H$ and [Output frequency] $r F_r$ become and stay lower than [Low speed] $L S P$ + [Sleep Offset Thres.] $S L E$ during [Low Speed Timeout] $t L S$.
- The motor is restarted when [Pre-Ramp Ref Freq] $F_r H > [Low speed] L S P + [Sleep Offset Thres.] S L E$.

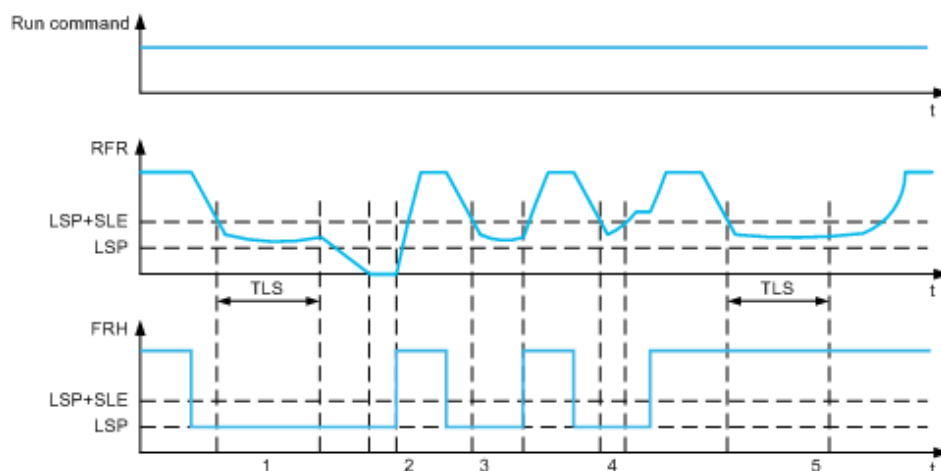

- 1 Nominal [Low Speed Timeout] $t L S$ function action: after [Low Speed Timeout] $t L S$ time, the motor is stopped according to the current deceleration ramp
- 2 [Pre-Ramp Ref Freq] $F_r H$ becomes greater than [Low speed] $L S P$ + [Sleep Offset Thres.] $S L E$ and run order still present [Low Speed Timeout] $t L S$ function is deactivated
- 3 [Low Speed Timeout] $t L S$ function is not activated because [Pre-Ramp Ref Freq] $F_r H$ becomes greater than [Low speed] $L S P$ + [Sleep Offset Thres.] $S L E$ before [Low Speed Timeout] $t L S$ has expired
- 4 [Low Speed Timeout] $t L S$ function is not activated because [Output frequency] $r F_r$ becomes greater than [Low speed] $L S P$ + [Sleep Offset Thres.] $S L E$ before [Low Speed Timeout] $t L S$ has expired
- 5 [Low Speed Timeout] $t L S$ function is not activated because [Pre-Ramp Ref Freq] $F_r H$ stays greater than [Low speed] $L S P$ + [Sleep Offset Thres.] $S L E$

[Low Speed Timeout] L L S

Time limited speed.

Setting 	Description
0.0...999.9 s	Setting range Factory setting: 0.0 s

[Sleep Offset Thres.] S L E

Sleep offset threshold.

Adjustable restart threshold (offset) following a stop after prolonged operation at **[Low speed] L S P + [Sleep Offset Thres.] S L E**, in Hz. The motor restarts if the reference rises above (LSP + SLE) and if a run command is still present.

Setting 	Description
1.0... [Max Frequency] L F r	Setting range Factory setting: 1.0 Hz

Section 6.17

[Generic functions] - [Advanced sleep check]

[Advanced sleep check] *AdS* - Menu

Access

[Complete settings] → [Generic functions] → [Advanced sleep check]

About This Menu

This function cannot be activated if [Type of control] *LoCt* is not set to [Pressure] *PrE55*.

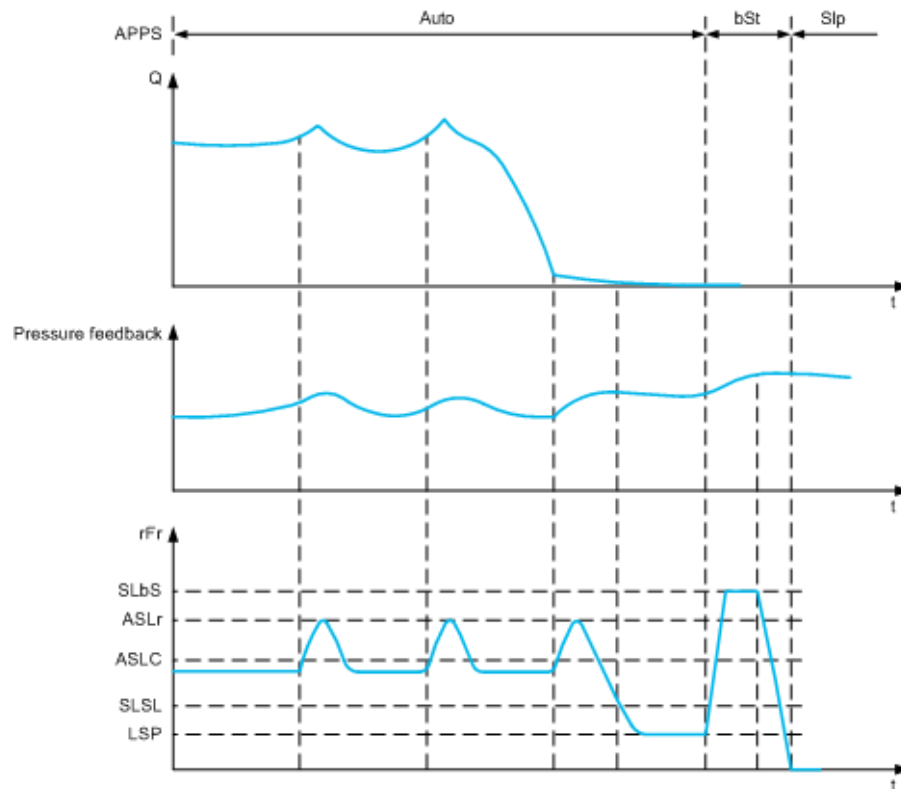

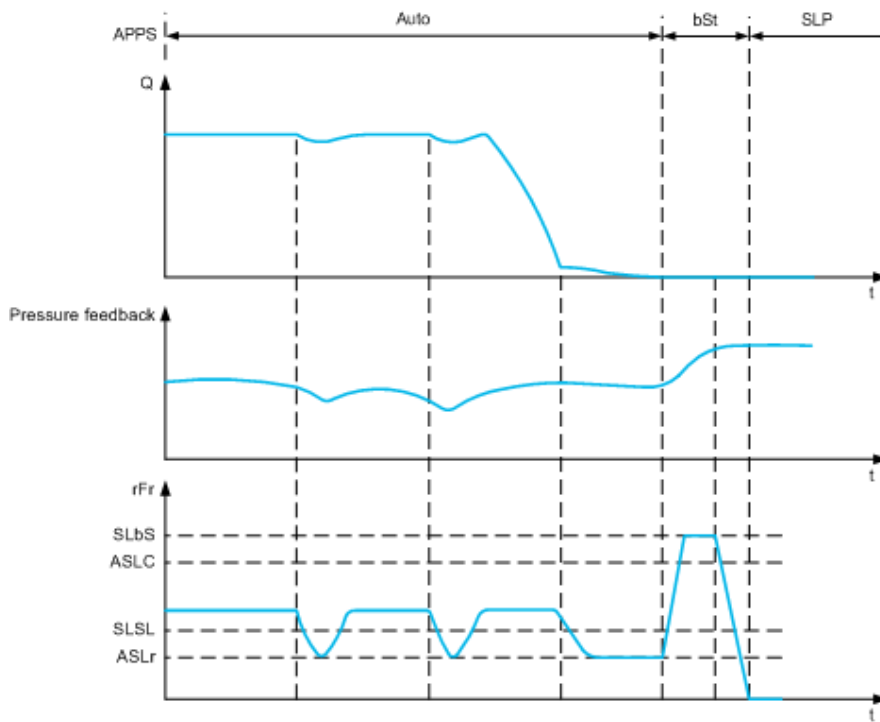

[Sleep Mode] # 5 L Π

Advanced sleep mode.

Setting ()	Code / Value	Description
[No]	n o	No Factory setting
[YES]	y e s	Yes

[Sleep Condition] # 5 L Γ ★

Advanced sleep verifies speed condition.

This parameter can be accessed if **[Sleep Mode] # 5 L Π** is not set to **[No] n o**.

Setting ()	Description
0...[High Speed] # 5 P	Setting range Factory setting: 0.0 Hz

[Sleep Delay] # 5 L d ★

Advanced sleep verifies delay.

This parameter can be accessed if **[Sleep Mode] # 5 L Π** is not set to **[No] n o**.

Setting ()	Description
0...9,999 s	Setting range Factory setting: 20 s

[Check Sleep Ref Spd] # 5 L r ★

Advanced sleep verifies speed reference.

This parameter can be accessed if **[Sleep Mode] # 5 L Π** is not set to **[No] n o**.

Setting ()	Description
0...599.0 Hz	Setting range Factory setting: 0.0 Hz

Section 6.18

[Generic monitoring]

What Is in This Section?

This section contains the following topics:

Topic	Page
[Stall monitoring] 5 L P r - Menu	226
[Therm sensor monit] 7 L 5 P - Menu	227

[Stall monitoring] 5 Ł P r - Menu

Access

[Complete settings] → [Generic monitoring] → [Stall monitoring]

About This Menu

This function helps to prevent a motor overload by monitoring the motor current and the speed rise time.

A stalling condition is when:

- An output frequency is smaller than the stalling frequency **[Stall Frequency] 5 Ł P 3**
- And an output current is higher than the stalling current **[Stall Current] 5 Ł P 2**
- During a time longer than the stalling time **[Stall Max Time] 5 Ł P 1**

When a stalling condition occurs, an **[Motor Stall Error] 5 Ł F** error is triggered.

[Stall Monitoring] 5 Ł P C

Stall monitoring activation.

Setting	Code / Value	Description
[No]	n o	Function disabled Factory setting
[Yes]	y e s	Function enabled

[Stall Max Time] 5 Ł P 1 ★

Motor stall maximum time.

This parameter can be accessed if **[Stall Monitoring] 5 Ł P C** is not set to **[No] n o**.

Setting ()	Description
0.0...200 s	Setting range Factory setting: 60.0 s

[Stall Current] 5 Ł P 2 ★

Stall monitoring current level.

This parameter can be accessed if **[Stall Monitoring] 5 Ł P C** is not set to **[No] n o**.

Setting ()	Description
0.0...150.0%	Setting range Factory setting: 150.0%

[Stall Frequency] 5 Ł P 3 ★

Stall monitoring frequency level.

This parameter can be accessed if **[Stall Monitoring] 5 Ł P C** is not set to **[No] n o**.

Setting ()	Description
0.0...20.0 Hz	Setting range Factory setting: 2.0 Hz

[Therm sensor monit] П E 5 P - Menu

Access

[Complete settings] → [Generic monitoring] → [Therm sensor monit]

About this menu

The Thermal monitoring function helps to prevent against high temperature by monitoring the real temperature by the drive.

PTC, PT100, PT1000 and KTY84 thermal probes are supported by this function.

The function gives the possibility to manage 2 levels of monitoring:

- A Warning level: the drive will trigger an event without stopping the application.
- An Error level: the drive will trigger an event and stop the application.

The thermal probe is monitored for the following detected error:

- Overheating
- Probe break (loss of signal)
- Probe short-circuit

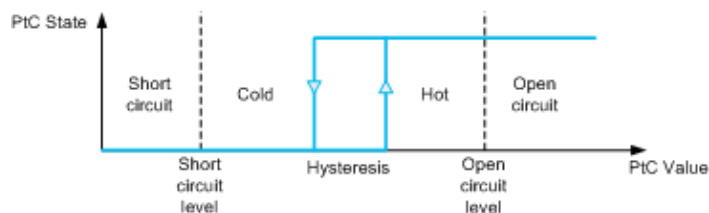

Activation

[Alx Th Monitoring] E H X 5 allows to activate the thermal monitoring on the related Analog Input:

- [No] n o: the function is disabled
- [Yes] Y E 5: the thermal monitoring is enabled on the related Alx.

Type of Thermal Probe Selection

[Alx Type] R , X E allows to select the type of thermal sensor(s) connected on the related Analog Input:

- [No] n o: no sensor
- [PTC Management] K E 4: 1 to 6 PTC (in serial) is used
- [KTY] K E 4: 1 KTY84 is used
- [PT100] I P E 2: 1 PT100 connected with 2 wires is used
- [3PT100] Э P E 2: 3 PT100 connected with 2 wires are used
- [PT1000] I P E 3: 1 PT1000 connected with 2 wires is used
- [3PT1000] Э P E 3: 3 PT1000 connected with 2 wires are used
- [PT100 in 3 wires] I P E 2 Э: 1 PT100 connected with 3 wires is used (AI4 & AI5 only)
- [3PT100 in 3 wires] Э P E 2 Э: 3 PT100 connected with 3 wires are used (AI4 & AI5 only)
- [PT1000 in 3 wires] I P E 3 Э: 1 PT1000 connected with 3 wires is used (AI4 & AI5 only)
- [3PT1000 in 3 wires] Э P E 3 Э: 3 PT1000 connected with 3 wires are used (AI4 & AI5 only)

2-wire thermal probes are supported on Analog Input 2 to Analog Input 5.

3-wire thermal probes are supported on Analog Input 4 and Analog Input 5. These inputs are available with the I/O extension option module.

If the probe is far from the drive, the 3-wire connection is recommended as compared to a 2-wire connection.

Wiring

For 2-wire probes, the following wirings are possible:

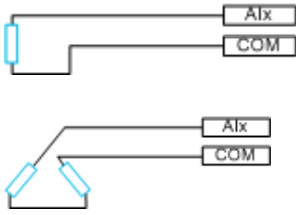

For 3-wire probes, the following wirings are possible:

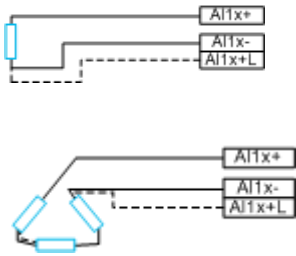

[AI2 Th Monitoring] 4 H 2 5

Activation of the thermal monitoring on AI2.

Setting	Code / Value	Description
[No]	n o	No Factory setting
[YES]	4 E 5	Yes

[AI2 Type] 4 1 2 4 ★

AI2 assignment.

This parameter can be accessed if **[AI2 Th Monitoring] 4 H 2 5** is not set to **[No] n o**.

Setting	Code / Value	Description
[Voltage]	1 0 v	0-10 Vdc
[Current]	0 A	0-20 mA Factory setting
[PTC Management]	P t C	1 to 6 PTC (in serial)
[KTY]	K t Y	1 KTY84
[PT1000]	1 P t 3	1 PT1000 connected with 2 wires
[PT100]	1 P t 2	1 PT100 connected with 2 wires
[Water Prob]	L E u E L	Water level
[3PT1000]	3 P t 3	3 PT1000 connected with 2 wires
[3PT100]	3 P t 2	3 PT100 connected with 2 wires

[AI2 Th Error Resp] Ɛ H 2 Ɓ ★

Thermal monitoring response to a detected error for AI2.

This parameter can be accessed if **[AI2 Type] Ɛ 2 Ɛ** is not set to

- **[Voltage] 1 0 Ʃ**, or
- **[Current] 0 Ɛ**.

Setting	Code / Value	Description
[Ignore]	0 0	Detected error ignored
[Freewheel Stop]	4 Ɛ 5	Freewheel stop
[Per STT]	5 Ɛ Ɛ	Stop according to [Type of stop] 5 Ɛ Ɛ parameter but without an error triggered after stop
[Fallback Speed]	L F F	Change to fallback speed, maintained as long as the detected error persists and the run command has not been removed ⁽¹⁾
[Ramp stop]	r Ɛ P	Stop on ramp Factory setting

1 Because, in this case, the detected error does not trigger a stop, it is recommended to assign a relay or logic output to its indication.

[AI2 Th Error Level] Ɛ H 2 F ★

Error detection level for AI2.

This parameter can be accessed if **[AI2 Type] Ɛ 2 Ɛ** is not set to:

- **[Voltage] 1 0 Ʃ**, or
- **[Current] 0 Ɛ**, or
- **[PTC Management] P Ɛ Ɛ**.

Setting (°)	Description
-15.0...200.0°C	Setting range Factory setting: 110.0°C

[AI2 Th Warn Level] Ɛ H 2 Ɛ ★

Warning level for AI2.

This parameter can be accessed if **[AI2 Type] Ɛ 2 Ɛ** is not set to:

- **[Voltage] 1 0 Ʃ**, or
- **[Current] 0 Ɛ**, or
- **[PTC Management] P Ɛ Ɛ**.

Setting (°)	Description
-15.0...200.0°C	Setting range Factory setting: 90.0°C

[AI2 Th Value] Ɛ H 2 Ʃ ★

AI2 thermal value.L

This parameter can be accessed if **[AI2 Type] Ɛ 2 Ɛ** is not set to:

- **[Voltage] 1 0 Ʃ**, or
- **[Current] 0 Ɛ**, or
- **[PTC Management] P Ɛ Ɛ**.

Setting	Description
-32,768...32,767	Setting range Factory setting: _

[AI3 Th Monitoring] Ɛ H 3 5

Activation of the thermal monitoring on AI3.

Setting	Code / Value	Description
[No]	0 0	No Factory setting
[YES]	4 Ɛ 5	Yes

[AI3 Type] R , 3 E ★

AI3 assignment.

This parameter can be accessed if **[AI3 Th Monitoring] E H 3 5** is not set to **[No] n o**.

Identical to **[AI2 Type] R , 2 E** (see page 228).

[AI3 Th Error Resp] E H 3 6 ★

Thermal monitoring response to a detected error for AI3.

This parameter can be accessed if **[AI3 Type] R , 3 E** is not set to:

- **[Voltage] I D u**, or
- **[Current] D R**, or

Setting	Code / Value	Description
[Ignore]	n o	Detected error ignored
[Freewheel Stop]	4 E 5	Freewheel stop
[Per STT]	5 E E	Stop according to [Type of stop] 5 E E parameter but without an error triggered after stop
[Fallback Speed]	L F F	Change to fallback speed, maintained as long as the detected error persists and the run command has not been removed ⁽¹⁾
[Ramp stop]	r P P	Stop on ramp Factory setting

1 Because, in this case, the detected error does not trigger a stop, it is recommended to assign a relay or logic output to its indication.

[AI3 Th Error Level] E H 3 F ★

Error detection level for AI3.

This parameter can be accessed if **[AI3 Type] R , 3 E** is not set to:

- **[Voltage] I D u**, or
- **[Current] D R**, or
- **[PTC Management] P E C**.

Setting ()	Description
-15.0...200.0°C	Setting range Factory setting: 110.0°C

[AI3 Th Warn Level] E H 3 A ★

Warning level for AI3.

This parameter can be accessed if **[AI3 Type] R , 3 E** is not set to:

- **[Voltage] I D u**, or
- **[Current] D R**, or
- **[PTC Management] P E C**.

Setting ()	Description
-15.0...200.0°C	Setting range Factory setting: 90.0°C

[AI3 Th Value] E H 3 u ★

AI3 thermal value.

This parameter can be accessed if **[AI3 Type] R , 3 E** is not set to:

- **[Voltage] I D u**, or
- **[Current] D R**, or
- **[PTC Management] P E C**.

Setting	Description
-32,768...32,767	Setting range Factory setting: _

[AI4 Th Monitoring] Ɛ H 4 5 ★

Activation of the thermal monitoring on AI4.

This parameter can be accessed if VW3A3203 relay output option module has been inserted.

Setting	Code / Value	Description
[No]	n o	No Factory setting
[YES]	Y E 5	Yes

[AI4 Type] A , 4 Ɛ ★

AI4 assignment.

This parameter can be accessed if **[AI4 Th Monitoring] Ɛ H 4 5** is not set to **[No] n o**.

Setting	Code / Value	Description
[Voltage]	1 0 u	0-10 Vdc
[Current]	0 A	0-20 mA
[Voltage +/-]	n 1 0 u	-10/+10 Vdc Factory setting
[PTC Management]	P Ɛ C	1 to 6 PTC (in serial)
[KTY]	K Ɛ Y	1 KTY84
[PT1000]	1 P Ɛ 3	1 PT1000 connected with 2 wires
[PT100]	1 P Ɛ 2	1 PT100 connected with 2 wires
[3 PT1000]	3 P Ɛ 3	3 PT1000 connected with 2 wires
[3 PT100]	3 P Ɛ 2	3 PT100 connected with 2 wires
[PT1000 in 3 wires]	1 P Ɛ 3 3	1 PT1000 connected with 3 wires (AI4 & AI5 only)
[PT100 in 3 wires]	1 P Ɛ 2 3	1 PT100 connected with 3 wires (AI4 & AI5 only)
[3 PT1000 in 3 wires]	3 P Ɛ 3 3	3 PT1000 connected with 3 wires (AI4 & AI5 only)
[3 PT100 in 3 wires]	3 P Ɛ 2 3	3 PT100 connected with 3 wires (AI4 & AI5 only)

[AI4 Th Error Resp] Ɛ H 4 Ɔ ★

Thermal monitoring response to a detected error for AI4.

This parameter can be accessed if:

- **[AI4 Type] A , 4 Ɛ** is not set to **[Voltage] 1 0 u**, or
- **[AI4 Type] A , 4 Ɛ** is not set to **[Current] 0 A**.

Setting	Code / Value	Description
[Ignore]	n o	Detected error ignored
[Freewheel Stop]	Y E 5	Freewheel stop
[Per STT]	5 Ɛ Ɛ	Stop according to [Type of stop] 5 Ɛ Ɛ parameter but without an error triggered after stop
[Fallback Speed]	L F F	Change to fallback speed, maintained as long as the detected error persists and the run command has not been removed ⁽¹⁾
[Ramp stop]	r P P	Stop on ramp Factory setting

1 Because, in this case, the detected error does not trigger a stop, it is recommended to assign a relay or logic output to its indication.

[AI4 Th Error Level] E H 4 F ★

Error detection level for AI4.

This parameter can be accessed if **[AI4 Type] R , 4 E** is not set to:

- **[Voltage] I D U**, or
- **[Current] D R**, or
- **[PTC Management] P E C**.

Setting ()	Description
-15.0...200.0°C	Setting range Factory setting: 110.0°C

[AI4 Th Warn Level] E H 4 R ★

Warning level for AI4.

This parameter can be accessed if **[AI4 Type] R , 4 E** is not set to:

- **[Voltage] I D U**, or
- **[Current] D R**, or
- **[PTC Management] P E C**.

Setting ()	Description
-15.0...200.0°C	Setting range Factory setting: 90.0°C

[AI4 Th Value] E H 4 U ★

AI4 thermal value.

This parameter can be accessed if **[AI4 Type] R , 4 E** is not set to:

- **[Voltage] I D U**, or
- **[Current] D R**, or
- **[PTC Management] P E C**.

Setting	Description
-32,768...32,767	Setting range Factory setting: _

[AI5 Th Monitoring] E H 5 5 ★

Activation of the thermal monitoring on AI5.

This parameter can be accessed if VW3A3203 relay output option module has been inserted.

Setting	Code / Value	Description
[No]	n o	No Factory setting
[YES]	y e s	Yes

[AI5 Type] R , 5 E ★

AI5 assignment.

This parameter can be accessed if **[AI5 Th Monitoring] E H 5 5** is not set to **[No] n o**.

Identical to **[AI4 Type] R , 4 E** (*see page 231*).

[AI5 Th Error Resp] E H 5 b ★

Thermal monitoring response to a detected error for AI5.

This parameter can be accessed if:

- **[AI5 Type] R , 5 E** is not set to **[Voltage] I D U**, or
- **[AI5 Type] R , 5 E** is not set to **[Current] D R**.

Setting	Code / Value	Description
[Ignore]	<i>n o</i>	Detected error ignored
[Freewheel Stop]	<i>Y E S</i>	Freewheel stop
[Per STT]	<i>S E E</i>	Stop according to [Type of stop] S E E parameter but without an error triggered after stop
[Fallback Speed]	<i>L F F</i>	Change to fallback speed, maintained as long as the detected error persists and the run command has not been removed ⁽¹⁾
[Ramp stop]	<i>r P P</i>	Stop on ramp Factory setting

1 Because, in this case, the detected error does not trigger a stop, it is recommended to assign a relay or logic output to its indication.

[AI5 Th Error Level] E H 5 F ★

Error detection level for AI5.

This parameter can be accessed if **[AI5 Type] R , 5 E** is not set to:

- **[Voltage] I D U**, or
- **[Current] D R**, or
- **[PTC Management] P E C**.

Setting ()	Description
-15.0...200.0°C	Setting range Factory setting: 110.0°C

[AI5 Th Warn Level] E H 5 R ★

Warning level for AI5.

This parameter can be accessed if **[AI5 Type] R , 5 E** is not set to:

- **[Voltage] I D U**, or
- **[Current] D R**, or
- **[PTC Management] P E C**.

Setting ()	Description
-15.0...200.0°C	Setting range Factory setting: 90.0°C

[AI5 Th Value] E H 5 U

AI5 thermal value.

This parameter can be accessed if **[AI5 Type] R , 5 E** is not set to:

- **[Voltage] I D U**, or
- **[Current] D R**, or
- **[PTC Management] P E C**.

Setting	Description
-32,768...32,767	Setting range Factory setting: _

Section 6.19

[Error/Warning handling]

What Is in This Section?

This section contains the following topics:

Topic	Page
[Fault reset] <i>r 5 t</i> - Menu	235
[Auto fault reset] <i>R t r</i> - Menu	237
[Catch on the fly] <i>F L r</i> - Menu	238
[Motor thermal monit] <i>t H t</i> - Menu	239
[Output phase loss] <i>o P L</i> - Menu	240
[Input phase loss] <i>i P L</i> - Menu	241
[External error] <i>E t F</i> - Menu	242
[Undervoltage handling] <i>u S b</i> - Menu	243
[4-20mA loss] <i>L F L</i> - Menu	245
[Error detection disable] <i>i n H</i> - Menu	246
[Fieldbus monitoring] <i>C L L</i> - Menu	247
[Error/Warning handling] <i>C S W n</i> - Menu	248
[Process underload] <i>u L d</i> - Menu	249
[Process overload] <i>o L d</i> - Menu	251
[Warn grp 1 definition] <i>R 1 C</i> - Menu	253
[Warn grp 2 definition] <i>R 2 C</i> - Menu	255
[Warn grp 3 definition] <i>R 3 C</i> - Menu	256
[Warn grp 4 definition] <i>R 4 C</i> - Menu	257
[Warn grp 5 definition] <i>R 5 C</i> - Menu	258

[Fault reset] r 5 E - Menu**Access**

[Complete settings] → [Error/Warning handling] → [Fault reset]

[Fault Reset Assign] r 5 F

Error reset input assignment.

Detected errors are cleared manually when the assigned input or bit changes to 1 if the cause of the detected error has disappeared.

The STOP/RESET key on the Plain Text Display Terminal performs the same function.

Setting	Code / Value	Description
[Not Assigned]	n o	Not assigned
[DI1]...[DI6]	L , I...L , 5	Digital input DI1...DI6 Factory setting: DI2
[DI11]...[DI16]	L , I I...L , I 5	Digital input DI11...DI16 if VW3A3203 I/O extension module has been inserted

[Product Restart] r P ★

The Restart function performs a Fault Reset and then restarts the drive. During this Restart procedure, the drive goes through the same steps as if it had been switched off and on again. Depending on the wiring and the configuration of the drive, this may result in immediate and unanticipated operation.

⚠ WARNING

UNANTICIPATED EQUIPMENT OPERATION

The Restart function performs a Fault Reset and restarts the drive.

- Verify that activating this function does not result in unsafe conditions.

Failure to follow these instructions can result in death, serious injury, or equipment damage.

Product restart.

This parameter can only be accessed if [Access Level] L R C is set to [Expert] E P r mode.

Drive reinitialization. Can be used to reset all detected errors without having to disconnect the drive from the supply mains.

Setting	Code / Value	Description
[No]	n o	Function inactive Factory setting
[Yes]	Y E 5	Reinitialization. Press and hold down the OK key for 2 s. The parameter changes back to [No] n o automatically as soon as the operation is complete. The drive can only be reinitialized when locked.

[Prod Restart Assign] *r P R* ★ 

Product restart assignment.

The Restart function performs a Fault Reset and then restarts the drive. During this Restart procedure, the drive goes through the same steps as if it had been switched off and on again. Depending on the wiring and the configuration of the drive, this may result in immediate and unanticipated operation. The Restart function can be assigned to a digital input

⚠ WARNING

UNANTICIPATED EQUIPMENT OPERATION

The Restart function performs a Fault Reset and restarts the drive.

- Verify that activating this function does not result in unsafe conditions.

Failure to follow these instructions can result in death, serious injury, or equipment damage.

This parameter can only be modified if **[Access Level]** *L A C* is set to **[Expert]** *E P r* mode.

Drive reinitialization via digital input. Can be used to reset all detected errors without having to disconnect the drive from the supply mains. The drive is reinitialized on a rising edge (change from 0 to 1) of the assigned input. The drive can only be reinitialized when locked.

Setting	Code / Value	Description
[Not Assigned]	<i>n o</i>	Not assigned Factory setting
[DI1]...[DI6]	<i>L 1 / 1...L 1 6</i>	Digital input DI1...DI6
[DI11]...[DI16]	<i>L 1 1 / 1...L 1 1 6</i>	Digital input DI11...DI16 if VW3A3203 I/O extension module has been inserted

[Auto fault reset] *A E r* - Menu

Access

[Complete settings] → [Error/Warning handling] → [Auto fault reset]

[Auto Fault Reset] *A E r*

Automatic restart.

This function can be used to automatically perform individual or multiple Fault Resets. If the cause of the error that has triggered the transition to the operating state Fault disappears within while this function is active, the drive resumes normal operation. While the Fault Reset attempts are performed automatically, the output signal **[Operating state Fault]** is not available. If the attempts to perform the Fault Reset are not successful, the drive remains in the operating state Fault and the output signal **[Operating state Fault]** becomes active.

WARNING

UNANTICIPATED EQUIPMENT OPERATION

- Verify that activating this function does not result in unsafe conditions.
- Verify that the fact that the output signal "Operating state Fault" is not available while this function is active does not result in unsafe conditions.

Failure to follow these instructions can result in death, serious injury, or equipment damage.

The drive fault relay remains activated if this function is active. The speed reference and the operating direction must be maintained.

It is recommended to use 2-wire control (**[2/3-wire control] *E C C*** is set to **[2 wire] *2 C*** and **[2-wire type] *E C E*** is set to **[Level] *L E L***, refer to **[2/3-wire control] *E C C***).

If the restart has not taken place once the configurable time **[Fault Reset Time] *E R r*** has elapsed, the procedure is aborted and the drive remains locked until it is turned off and then on again.

The detected error codes, which permit this function, are listed in the Diagnostics part of the manual.

Setting	Code / Value	Description
[No]	<i>n 0</i>	Function inactive Factory setting
[Yes]	<i>Y E 5</i>	Automatic restart, after locking in error state, if the detected error has disappeared and the other operating conditions permit the restart. The restart is performed by a series of automatic attempts separated by increasingly longer waiting periods: 1 s, 5 s, 10 s, then 1 minute for the following attempts.

[Fault Reset Time] *E R r* ★

Maximum time for automatic restart function.

This parameter appears if **[Auto Fault Reset] *A E r*** is set to **[Yes] *Y E 5***. It can be used to limit the number of consecutive restarts on a recurrent detected error.

Setting	Code / Value	Description
[5 minutes]	<i>5</i>	5 minutes Factory setting
[10 minutes]	<i>1 0</i>	10 minutes
[30 minutes]	<i>3 0</i>	30 minutes
[1 hour]	<i>1 h</i>	1 hour
[2 hours]	<i>2 h</i>	2 hours
[3 hours]	<i>3 h</i>	3 hours
[Unlimited]	<i>C E</i>	Continuous

[Catch on the fly] FLr - Menu

Access

[Complete settings] → [Error/Warning handling] → [Catch on the fly]

[Catch On Fly] FLr

Catch on the fly.

Used to enable a smooth restart if the run command is maintained after the following events:

- Loss of line supply or disconnection.
- Clearance of current detected error or automatic restart.
- Freewheel stop.

The speed given by the drive resumes from the estimated speed of the motor at the time of the restart, then follows the ramp to the reference speed.

This function requires 2-wire level control.

When the function is operational, it activates at each run command, resulting in a slight delay of the current (0.5 s max).

[Catch On Fly] FLr is forced to [No] no if [Auto DC Injection] AdC is set to [Continuous] CE.

Setting	Code / Value	Description
[No]	no	Function inactive Factory setting
[Yes]	YES	Function active

[Catch on Fly Sensitivity] LCB★

Catch on fly sensitivity.

This parameter can only be accessed if [Access Level] LAC is set to [Expert] EPr.

Setting	Description
0,10...100.00 V	Setting range Factory setting: 20 V

[Motor thermal monit] *E H E* - Menu

Access

[Complete settings] → [Error/Warning handling] → [Motor thermal monit]

About This Menu

[Motor Thermal Mode] *E H E*

Motor thermal monitoring mode.

NOTE: An error is detected when the thermal state reaches 118% of the rated state and reactivation occurs when the state falls back below 100%.

Setting	Code / Value	Description
[No]	<i>n o</i>	No thermal protection
[Self cooled]	<i>F C L</i>	Self ventilated motor Factory setting
[Force-cool]	<i>F C L</i>	Fan-cooled motor

[MotorTemp ErrorResp] *o L L*

Overload error response.

Setting	Code / Value	Description
[Ignore]	<i>n o</i>	Detected error ignored
[Freewheel Stop]	<i>Y E 5</i>	Free wheel Factory setting

[Motor Thermal Thd] *E E d*

Motor thermal state threshold.

Setting 	Description
0...118%	Setting range Factory setting: 100%

[Output phase loss] $\alpha P L$ - Menu

Access

[Complete settings] → [Error/Warning handling] → [Output phase loss]

[OutPhaseLoss Assign] $\alpha P L$ 

Output phase loss assignment.

 **DANGER**

HAZARD OF ELECTRIC SHOCK, EXPLOSION OR ARC FLASH

If output phase monitoring is disabled, phase loss and, by implication, accidental disconnection of cables, are not detected.

- Verify that the setting of this parameter does not result in unsafe conditions.

Failure to follow these instructions will result in death or serious injury.

NOTE: [OutPhaseLoss Assign] $\alpha P L$ is set to [Function Inactive] $n \alpha$ when [Motor control type] $C E E$ is set to [SYN_U VC] $S Y n u$.

Setting	Code / Value	Description
[Function Inactive]	$n \alpha$	Function inactive
[OPF Error Triggered]	$Y E 5$	Tripping on [OutPhaseLoss Assign] $\alpha P L$ with freewheel stop Factory setting
[No Error Triggered]	$\alpha P L$	No detected error triggered, but management of the output voltage in order to avoid an overcurrent when the link with the motor is re-established and catch on the fly performed (even if this function has not been configured).The drive switches to [Output cut] $S \alpha L$ state after [OutPhL Time] $\alpha d t$ time. Catch on fly is possible as soon as the drive is in stand by output cut [Output cut] $S \alpha L$ state.

[OutPhaseLoss Delay] $\alpha d t$

Output (motor) phase loss detection time.

Time delay for taking the [OutPhaseLoss Assign] $\alpha P L$ detected error into account.

Setting (s)	Description
0.5...10 s	Setting range Factory setting: 0.5 s

[Input phase loss] , P L - Menu**Access**

[Complete settings] → [Error/Warning handling] → [Input phase loss]

[InPhaseLoss Assign] , P L  

Loss of input phase error response.

Setting	Code / Value	Description
[Ignore]	n o	Detected error ignored
[Freewheel Stop]	Y E S	Freewheel stop Factory setting
[Per STT]	S E E	Stop according to [Type of stop] S E E parameter but without an error triggered after stop
[Fallback Speed]	L F F	Change to fallback speed, maintained as long as the detected error persists and the run command has not been removed ⁽¹⁾
[Ramp stop]	r P P	Stop on ramp

1 Because, in this case, the detected error does not trigger a stop, it is recommended to assign a relay or logic output to its indication.

[External error] E L F - Menu

Access

[Complete settings] → [Error/Warning handling] → [External error]

[Ext Error Assign] E L F

External error assignment.

If the assigned bit state is:

- 0: there is no external error.
- 1: there is an external error

Setting	Code / Value	Description
[Not Assigned]	n o	Not assigned Factory setting
[DI1]...[DI6]	L , I ... L , 6	Digital input DI1...DI6
[DI11]...[DI16]	L , I I ... L , 16	Digital input DI11...DI16 if VW3A3203 I/O extension module has been inserted
[CD00]...[CD10]	C d 0 0 ... C d 1 0	Virtual digital input CMD.0...CMD.10 in [I/O profile] , o configuration
[CD11]...[CD15]	C d 1 1 ... C d 1 5	Virtual digital input CMD.11...CMD.15 regardless of configuration
[C100]...[C110]	C 1 0 0 ... C 1 1 0	Virtual digital input CMD1.0...CMD1.10 with integrated Modbus Serial in [I/O profile] , o configuration
[C111]...[C115]	C 1 1 1 ... C 1 1 5	Virtual digital input CMD1.11...CMD1.15 with integrated Modbus Serial regardless of configuration
[C300]...[C310]	C 3 0 0 ... C 3 1 0	Virtual digital input CMD3.0...CMD3.10 with a fieldbus module in [I/O profile] , o configuration
[C311]...[C315]	C 3 1 1 ... C 3 1 5	Virtual digital input CMD3.11...CMD3.15 with a fieldbus module regardless of configuration
[DI1 (Low level)]...[DI6 (Low level)]	L I L ... L 6 L	Digital input DI1...DI6 used at low level
[DI11 (Low level)]...[DI16 (Low level)]	L I I L ... L 16 L	Digital input DI11...DI16 used at low level if VW3A3203 I/O extension module has been inserted

[Ext Error Resp] E P L

Drive response to external error.

Type of stop in the event of an external detected error.

Setting	Code / Value	Description
[Ignore]	n o	External detected error ignored
[Freewheel Stop]	4 E 5	Freewheel stop Factory setting
[Per STT]	5 E E	Stop according to configuration of [Type of stop] 5 E E (see page 154) , without tripping. In this case, the detected error relay does not open and the drive is ready to restart as soon as the detected error disappears, according to the restart conditions of the active command channel (for example, according to [2/3-wire control] E L E and [2-wire type] E L E if control is via the terminals). Configuring a warning for this detected error is recommended (assigned to a digital output, for example) in order to indicate the cause of the stop.
[Fallback speed]	L F F	Change to fallback speed, maintained as long as the detected error persists and the run command has not been removed ⁽¹⁾
[Speed maintained]	r L 5	The drive maintains the speed being applied when the detected error occurred, as long as the detected error is present and the run command has not been removed ⁽¹⁾
[Ramp stop]	r P P	Stop on ramp
[Fast stop]	F 5 E	Fast stop
[DC Injection]	d C ,	DC injection stop. This type of stop cannot be used with some other functions.
⁽¹⁾ Because, in this case, the detected error does not trigger a stop, it is recommended to assign a relay or digital output to its indication.		

[Undervoltage handling] ▾ 5 b - Menu

Access

[Complete settings] → [Error/Warning handling] → [Undervoltage handling]

[Undervoltage Resp] ▾ 5 b

Response to undervoltage.

Setting	Code / Value	Description
[Error Triggered]	0	The drive trips and the external detected error signal are triggered (the detected error relay assigned to [Operating State Fault] <i>F L E</i> will be opened) Factory setting
[Error Triggered w/o Relay]	1	The drive trips but the external detected error signal is not triggered (the detected error relay assigned to [Operating State Fault] <i>F L E</i> remains closed)
[Warning Triggered]	2	The warning and detected error relay remain closed. The warning can be assigned to a digital output or a relay

[Mains Voltage] ▾ r E 5

Mains voltage.

Settings	Code / Value	Description
[200 Vac]	2 0 0	200 Vac
[220 Vac]	2 2 0	220 Vac
[230 Vac]	2 3 0	230 Vac
[240 Vac]	2 4 0	240 Vac
[380 Vac]	3 8 0	380 Vac
[400 Vac]	4 0 0	400 Vac
[415 Vac]	4 1 5	415 Vac Factory setting
[440 Vac]	4 4 0	440 Vac
[460 Vac]	4 6 0	460 Vac
[480 Vac]	4 8 0	480 Vac
[525 Vac]	5 2 5	525 Vac
[575 Vac]	5 7 5	575 Vac
[600 Vac]	6 0 0	600 Vac
[690 Vac]	6 9 0	690 Vac

[Undervoltage Level] ▾ 5 L

Undervoltage level.

The factory setting is determined by the drive voltage rating.

Setting	Description
100...345 V	Setting range, according to drive rating Factory setting: According to drive rating

[UnderVolt Timeout] ▾ 5 E

Undervoltage timeout.

Setting	Description
0.2...999.9 s	Setting range Factory setting: 0.2 s

[CtrlStopPLoss] 5 E P

Controlled stop on power loss.

Behavior in the event of the undervoltage prevention level being reached.

Setting	Code / Value	Description
[No]	n o	No action Factory setting
[DC Maintain]	π π 5	This stop mode uses the inertia of the application to maintain the control block powered, and thus to keep operational I/O state and fieldbus link as long as possible.
[Ramp stop]	r π P	Stop following an adjustable deceleration ramp [Max stop time] 5 E π in order to help to prevent from uncontrolled stop of the application.
[Freewheel Stop]	L n F	Lock (freewheel stop) without triggering an error

[UnderV. Restart Tm] E 5 π ★

Undervoltage restart time.

This parameter can be accessed if **[CtrlStopPLoss] 5 E P** is set to **[Ramp stop] r π P**.

The time delay before authorizing the restart after a complete stop for **[CtrlStopPLoss] 5 E P** is set to **[Ramp stop] r π P** if the voltage has returned to normal.

Setting ()	Description
1.0...999.9 s	Setting range Factory setting: 1.0 s

[Prevention Level] u P L ★

Undervoltage prevention level.

This parameter can be accessed if **[CtrlStopPLoss] 5 E P** is set to **[No] n o**.

The adjustment range and factory setting are determined by the drive voltage rating and the **[Mains Voltage] u r E 5** value.

Setting	Description
141...414 V	Setting range Factory setting: According to drive rating

[Max Stop Time] 5 E π ★

Maximum stop time.

This parameter can be accessed if **[CtrlStopPLoss] 5 E P** is set to **[Ramp stop] r π P**.

This parameter defines the deceleration ramp time in case of mains loss. During this controlled stop, the drive is powered thanks to the inertia of the application, the motor is in generator mode. It is recommended to verify that the deceleration set is compatible with the application inertia.

Setting ()	Description
0.01...60.00 s	Setting range Factory setting: 1.00 s

[DC Bus Maintain Time] E b 5 ★

DC bus maintain time.

This parameter can be accessed if **[CtrlStopPLoss] 5 E P** is set to **[DC Maintain] π π 5**.

Setting ()	Description
1...9999 s	Setting range Factory setting: 9999 s

[4-20mA loss] L F L - Menu**Access**

[Complete settings] → [Error/Warning handling] → [4-20mA loss]

[AI1 4-20mA Loss] L F L I

Response to 4-20mA loss on AI1.

Drive behavior on AI1 4-20 event.

Setting	Code / Value	Description
[Ignore]	n o	Detected error ignored. This is the only possible configuration if [AI3 min. value] L r L 3 is not greater than 3 mA Factory setting
[Freewheel]	y e 5	Freewheel stop
[Per STT]	5 t t	Stop according to configuration of [Type of stop] 5 t t , without tripping. In this case, the error relay does not open and the drive is ready to restart as soon as the detected error disappears, according to the restart conditions of the active command channel (for example, according to [2/3-wire control] t t t and [2-wire type] t t t if control is via the terminals). Configuring a warning for this detected error is recommended (assigned to a digital output, for example) in order to indicate the cause of the stop
[fallback spd]	L F F	Change to fallback speed, maintained as long as the detected error persists and the run command has not been removed ⁽¹⁾
[Spd maint.]	r L 5	The drive maintains the speed being applied when the detected error occurred, as long as the detected error is present and the run command has not been removed ⁽¹⁾
[Ramp stop]	r P P	Stop on ramp
[Fast stop]	F 5 t	Fast stop
[DC injection]	d C i	DC injection stop. This type of stop cannot be used with some other functions

(1) Because, in this case, the detected error does not trigger a stop, it is recommended to assign a relay or digital output to its indication.

[AI2 4-20mA loss] L F L 2

Response to 4-20mA loss on AI2.

Drive behavior on AI2 4-20 event.

Identical to **[AI1 4-20mA Loss] L F L I**

[AI3 4-20mA loss] L F L 3

Response to 4-20mA loss on AI3.

Drive behavior on AI3 4-20 event.

Identical to **[AI1 4-20mA Loss] L F L I**

[AI4 4-20mA loss] L F L 4★

Response to 4-20mA loss on AI4.

Drive behavior on AI4 4-20 event.

Identical to **[AI1 4-20mA Loss] L F L I**

This parameter can be accessed if VW3A3203 I/O extension module has been inserted.

[AI5 4-20mA loss] L F L 5★

Response to 4-20mA loss on AI5.

Drive behavior on AI5 4-20 event.

Identical to **[AI1 4-20mA Loss] L F L I**

This parameter can be accessed if VW3A3203 I/O extension module has been inserted.

[Error detection disable] *INH* - Menu

Access

[Complete settings] → [Error/Warning handling] → [Error detection disable]

About This Menu

⚠ DANGER

MONITORING FUNCTIONS DISABLED, NO ERROR DETECTION

- Only use this parameter after a thorough risk assessment in compliance with all regulations and standards that apply to the device and to the application.
- Implement alternative monitoring functions for disabled monitoring functions that do not trigger automatic error responses of the drive, but allow for adequate, equivalent responses by other means in compliance with all applicable regulations and standards as well as the risk assessment.
- Commission and test the system with the monitoring functions enabled.
- During commissioning, verify that the drive and the system operate as intended by performing tests and simulations in a controlled environment under controlled conditions.

Failure to follow these instructions will result in death or serious injury.

[Error detection disable] *INH* ★

Disable error detection.

This parameter can be accessed if [Access Level] *LAC* is set to [Expert] *EP*.

Setting	Code / Value	Description
[Not Assigned]	<i>no</i>	Not assigned Factory setting
[DI1]...[DI6]	<i>L 1 1...L 1 6</i>	Digital input DI1...DI6
[DI11]...[DI16]	<i>L 1 1 1...L 1 1 6</i>	Digital input DI11...DI16 if VW3A3203 I/O extension module has been inserted
[CD00]...[CD10]	<i>C d 0 0...C d 1 0</i>	Virtual digital input CMD.0...CMD.10 in [I/O profile] <i>no</i> configuration
[CD11]...[CD15]	<i>C d 1 1...C d 1 5</i>	Virtual digital input CMD.11...CMD.15 regardless of configuration
[C100]...[C110]	<i>C 1 0 0...C 1 1 0</i>	Virtual digital input CMD1.0...CMD1.10 with integrated Modbus Serial in [I/O profile] <i>no</i> configuration
[C111]...[C115]	<i>C 1 1 1...C 1 1 5</i>	Virtual digital input CMD1.11...CMD1.15 with integrated Modbus Serial regardless of configuration
[C300]...[C310]	<i>C 3 0 0...C 3 1 0</i>	Virtual digital input CMD3.0...CMD3.10 with a fieldbus module in [I/O profile] <i>no</i> configuration
[C311]...[C315]	<i>C 3 1 1...C 3 1 5</i>	Virtual digital input CMD3.11...CMD3.15 with a fieldbus module regardless of configuration

[Fieldbus monitoring] L L L - Menu**Access**

[Complete settings] → [Error/Warning handling] → [Fieldbus monitoring]

[Modbus Error Resp] S L L

Stop mode at Modbus SLF.

⚠ WARNING

LOSS OF CONTROL

If this parameter is set to *n o*, Modbus communication monitoring is disabled.

- Only use this setting after a thorough risk assessment in compliance with all regulations and standards that apply to the device and to the application.
- Only use this setting for tests during commissioning.
- Verify that communication monitoring has been re-enabled before completing the commissioning procedure and performing the final commissioning test.

Failure to follow these instructions can result in death, serious injury, or equipment damage.

Behavior of the drive in the event of a communication interruption with integrated Modbus.

Setting	Code / Value	Description
[Ignore]	<i>n o</i>	Detected error ignored
[Freewheel]	<i>Y E S</i>	Freewheel stop Factory setting
[Per STT]	<i>S E E</i>	Stop according to configuration of [Type of stop] <i>S E E</i> , without tripping. In this case, the error relay does not open and the drive is ready to restart as soon as the detected error disappears, according to the restart conditions of the active command channel (for example, according to [2/3-wire control] <i>E C C</i> and [2-wire type] <i>E C E</i> if control is via the terminals) ⁽¹⁾
[fallback spd]	<i>L F F</i>	Change to fallback speed, maintained as long as the detected error persists and the run command has not been removed ⁽¹⁾
[Spd maint.]	<i>r L S</i>	The drive maintains the speed being applied when the detected error occurred, as long as the detected error is present and the run command has not been removed ⁽¹⁾
[Ramp stop]	<i>r P P</i>	Stop on ramp
[Fast stop]	<i>F S E</i>	Fast stop
[DC injection]	<i>d C i</i>	DC injection stop. This type of stop cannot be used with some other functions
⁽¹⁾ Because, in this case, the detected error does not trigger a stop, it is recommended to assign a relay or digital output to its indication.		

[Error/Warning handling] *Ⓛ 5WΠ* - Menu**Access**

[Complete settings] → [Error/Warning handling]

About This Menu**[Tuning Error Resp] *Ⓛ n L* ★**

Response to autotune error.

This parameter can be accessed if [Access Level] *L R C* is set to [Expert] *E P r*.

Setting	Code / Value	Description
[Ignore]	<i>n 0</i>	Detected error ignored
[Freewheel]	<i>4 E 5</i>	Freewheel stop Factory setting

[Process underload] $\mu L d$ - Menu

Access

[Complete settings] → [Error/Warning handling] → [Process underload]

Process Underload Detected Error

A process underload is detected when the next event occurs and remains pending for a minimum time [Unld T. Del. Detect] $\mu L t$, which is configurable:

- The motor is in steady state and the torque is below the set underload limit ([Unld.Thr.0.Speed] $L \mu L$, [Unld.Thr.Nom.Speed] $L \mu n$, [Unld. FreqThr. Det.] $r \Pi \mu d$ parameters).
- The motor is in steady state when the offset between the frequency reference and motor frequency falls below the configurable threshold [Hysteresis Freq] $S r b$.

Between zero frequency and the rated frequency, the curve reflects the following equation: Torque = $L \mu L + (L \mu n - L \mu L) \times (\text{frequency})^2 / (\text{rated frequency})^2$. The underload function is not active for frequencies below $r \Pi \mu d$.

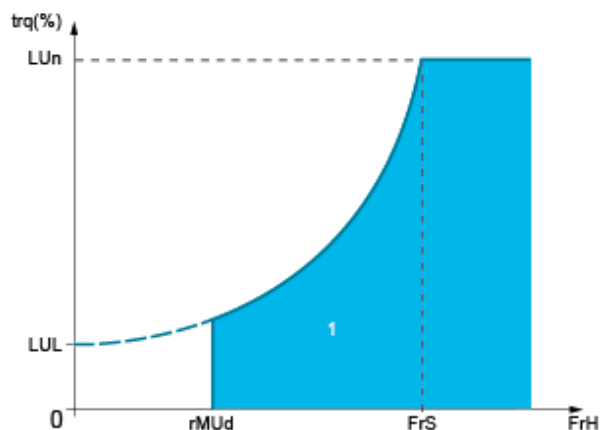

1 Underload zone.

A relay or a digital output can be assigned to the signaling of this detected error in the [Input/Output] $i o$ - , [I/O assignment] $i o \# 5$ - menus.

[Unld T. Del. Detect] $\mu L t$

Underload detection time delay.

A value of 0 deactivates the function and makes the other parameters inaccessible.

Setting	Description
0...100 s	Setting range Factory setting: 0 s

[Unld.Thr.Nom.Speed] $L \mu n$ ★

Underload threshold at nominal motor speed [Nominal Motor Freq] $F r S$, as a % of the rated motor torque.

This parameter can be accessed if [Unld T. Del. Detect] $\mu L t$ is not set to 0.

Setting ()	Description
20...100%	Setting range Factory setting: 60%

[Unld.Thr.0.Speed] L u L ★

Underload threshold at zero frequency as a % of the rated motor torque.
 This parameter can be accessed if **[Unld T. Del. Detect] u L t** is not set to 0.

Setting ()	Description
0...[Unld.Thr.Nom.Speed] L u n	Setting range Factory setting: 0%

[Unld. FreqThr. Det.] r n u d ★

Minimum frequency underload detection threshold.
 This parameter can be accessed if **[Unld T. Del. Detect] u L t** is not set to 0

Setting ()	Description
0.0...500.0 Hz	Setting range Factory setting: 0.0 Hz

[Hysteresis Freq] S r b ★

Maximum deviation between the frequency reference and the motor frequency, which defines a steady state operation.
 This parameter can be accessed if **[Unld T. Del. Detect] u L t** or **[Ovld Time Detect.] t o L** is not set to 0.

Setting ()	Description
0.3...500.0 Hz	Setting range Factory setting: 0.3 Hz

[Underload Mangmt.] u d L ★

Underload Management.
 Behavior on switching to underload detection.
 This parameter can be accessed if **[Unld T. Del. Detect] u L t** is not set to 0.

Setting	Code / Value	Description
[Ignore]	n o	Detected error ignored
[Freewheel]	y e s	Freewheel stop Factory setting
[Ramp stop]	r n p	Stop on ramp
[Fast stop]	f s t	Fast stop

[Underload T.B.Rest.] F t u ★

Minimum time permitted between an underload being detected and any automatic restart.
 To allow an automatic restart, the value of **[Fault Reset Time] t R r** must exceed this parameter by at least 1 minute.
 This parameter can be accessed if **[Underload Mangmt.] u d L** is not set to **[Ignore] n o**.

Setting ()	Description
0...6 min	Setting range Factory setting: 0 min

[Process overload] $\square L d$ - Menu

Access

[Complete settings] → [Error/Warning handling] → [Process overload]

About This Menu

A process overload error is detected when the next event occurs and remains pending for a minimum time **[Ovld Time Detect.] $t \square L$** , which is configurable:

- The drive is in current limitation mode.
- The motor is in steady state and the current is above the set overload threshold **[Ovld Detection Thr.] $L \square C$** .

The motor is in steady state when the offset between the frequency reference and motor frequency falls below the configurable threshold **[Hysteresis Freq] $S r b$** .

A relay or a digital output can be assigned to the signaling of this detected error.

[Ovld Time Detect.] $t \square L$

Overload reaction time.

A value of 0 deactivates the function and makes the other parameters inaccessible.

Setting	Description
0...100 s	Setting range Factory setting: 0 s

[Ovld Detection Thr.] $L \square C$ ★

Overload threshold.

Overload detection threshold, as a % of the rated motor current **[Nom Motor Current] $n C r$** . This value must be less than the limit current in order for the function to work.

This parameter can be accessed if **[Ovld Time Detect.] $t \square L$** is not set to 0.

Setting ()	Description
70...150%	Setting range Factory setting: 110%

[Hysteresis Freq] $S r b$ ★

Hysteresis for steady state.

Maximum deviation between the frequency reference and the motor frequency, which defines a steady state operation.

This parameter can be accessed if **[Ovld Time Detect.] $t \square L$** or **[Unld T. Del. Detect.] $u L t$** is not set to 0.

Setting ()	Description
0.3...500.0 Hz	Setting range Factory setting: 0.3 Hz

[Ovld.Proces.Mngmt] $\square d L$ ★

Behavior on switching to overload detection.

This parameter can be accessed if **[Ovld Time Detect.] $t \square L$** is not set to 0.

Setting	Code / Value	Description
[Ignore]	$n \square$	Detected error ignored
[Freewheel]	$Y E 5$	Freewheel stop Factory setting
[Ramp stop]	$r \Pi P$	Stop on ramp
[Fast stop]	$F 5 t$	Fast stop

[Overload T.B.Rest.] F E o ★

Minimum time permitted between an overload being detected and any automatic restart.

In order to allow an automatic restart, the value of **[Fault Reset Time] E R r** must exceed this parameter by at least 1 minute.

This parameter can be accessed if **[Ovld Time Detect.] E o L** or **[Unld T. Del. Detect.] u L E** is not set to 0.

Setting ()	Description
0...6 min	Setting range Factory setting: 0 min

[Warn grp 1 definition] *R I C* - Menu

Access

[Complete settings] → [Error/Warning handling] → [Warning groups config] → [Warn grp 1 definition]

About This Menu

The following submenus group the warnings into 1 to 5 groups, each of which can be assigned to a relay or a digital output for remote signaling.

When one or a number of warnings selected in a group occur, this warning group is activated.

List of Warnings

Setting	Code / Value	Description
[Fallback Frequency]	<i>F r F</i>	Fallback frequency
[Speed Maintained]	<i>r L S</i>	Speed maintained
[Type of stop]	<i>S t t</i>	Type of stop
[Ref Frequency Warning]	<i>S r R</i>	Reference frequency warning
[PID Error Warning]	<i>P E E</i>	PID error warning
[PID Feedback Warning]	<i>P F R</i>	PID feedback warning
[PID High Warning]	<i>P F R H</i>	PID high warning
[PID Low Warning]	<i>P F R L</i>	PID low warning
[Regulation Warning]	<i>P , S H</i>	Regulation warning
[AI2 Th Warning]	<i>t P 2 R</i>	AI2 thermal sensor warning
[AI3 Th Warning]	<i>t P 3 R</i>	AI3 thermal sensor warning
[AI4 Th Warning]	<i>t P 4 R</i>	AI4 thermal sensor warning
[AI5 Th Warning]	<i>t P 5 R</i>	AI5 thermal sensor warning
[AI1 4-20 Loss Warning]	<i>R P 1</i>	AI1 4-20 loss warning
[AI2 4-20 Loss Warning]	<i>R P 2</i>	AI2 4-20 loss warning
[AI3 4-20 Loss Warning]	<i>R P 3</i>	AI3 4-20 loss warning
[AI4 4-20 Loss Warning]	<i>R P 4</i>	AI4 4-20 loss warning
[AI5 4-20 Loss Warning]	<i>R P 5</i>	AI5 4-20 loss warning
[Drive Thermal Warning]	<i>t H R</i>	Drive thermal state warning
[IGBT Thermal Warning]	<i>t J R</i>	IGBT thermal warning
[Fan Counter Warning]	<i>F C t R</i>	Fan counter warning
[Fan Feedback Warning]	<i>F F d R</i>	Fan feedback warning
[Ext. Error Warning]	<i>E F R</i>	External error warning
[Undervoltage Warning]	<i>u S R</i>	Undervoltage warning

Setting	Code / Value	Description
[Preventive Undervolt Active]	<i>u P A</i>	Preventive undervoltage active
[Motor Freq High Thd]	<i>F E A</i>	Motor frequency high threshold reached
[Motor Freq Low Thd]	<i>F E A L</i>	Motor frequency low threshold reached
[Motor Freq High Thd 2]	<i>F 9 L A</i>	Motor frequency high threshold 2 reached
[Motor Freq Low Thd 2]	<i>F 2 A L</i>	Motor frequency low threshold 2 reached
[High speed reached]	<i>F L A</i>	High speed reached
[Ref Freq High Thd]	<i>r E A H</i>	Ref freq high Thd
[Ref Freq Low Thd]	<i>r E A L</i>	Ref freq low Thd
[2nd Frequency Thd Reached]	<i>F 2 A</i>	Second frequency threshold reached
[Current Threshold Reached]	<i>C E A</i>	Current threshold reached
[Low Current Reached]	<i>C E A L</i>	Low Current Reached
[Process Underload Warning]	<i>u L A</i>	Process underload warning
[Process Overload Warning]	<i>o L A</i>	Process overload warning
[Drive Thermal Thd Reached]	<i>t A d</i>	Drive thermal threshold reached
[Motor Therm Thd Reached]	<i>t S A</i>	Motor thermal threshold reached
[Power High Threshold]	<i>P E H A</i>	Power High Threshold
[Power Low Threshold]	<i>P E H L</i>	Power Low Threshold

[Warn grp 2 definition] *A 2 C* - Menu

Access

[Complete settings] → [Error/Warning handling] → [Warning groups config] → [Warn grp 2 definition]

About This Menu

Identical to [Warn grp 1 definition] *A 1 C* ([see page 253](#))

[Warn grp 3 definition] *A 3 C* - Menu

Access

[Complete settings] → [Error/Warning handling] → [Warning groups config] → [Warn grp 3 definition]

About This Menu

Identical to [Warn grp 1 definition] *A 1 C* (*see page 253*)

[Warn grp 4 definition] *A 4 C* - Menu

Access

[Complete settings] → [Error/Warning handling] → [Warning groups config] → [Warn grp 4 definition]

About This Menu

Identical to [Warn grp 1 definition] *A 1 C* ([see page 253](#))

[Warn grp 5 definition] *A 5 C* - Menu

Access

[Complete settings] → [Error/Warning handling] → [Warning groups config] → [Warn grp 5 definition]

About This Menu

Identical to [Warn grp 1 definition] *A 1 C* (*see page 253*)

Section 6.20

[Maintenance]

What Is in This Section?

This section contains the following topics:

Topic	Page
[Diagnostics] <i>d R U</i> - Menu	260
[Fan management] <i>F R P R</i> - Menu	261
[Maintenance] <i>C S P R</i> - Menu	262

[Diagnostics] *d R u* - Menu

Access

[Complete settings] → [Maintenance] → [Diagnostics]

About This Menu

This menu allows to make simple test sequences for diagnostics.

[FAN Diagnostics] *F n t*

Diagnostics of internal fan(s).

This will start a test sequence.

[LED Diagnostics] *H L t*

Diagnostics of product LED(s).

This will start a test sequence.

[IGBT diagnostics with motor] *i W t*

Diagnostics of internal fan(s).

This will start a test sequence with the motor (open circuit/short-circuit).

[IGBT diagnostics w/o motor] *i W o t*

Diagnostics of product IGBT(s).

This will start a test sequence without the motor (short-circuit).

[Fan management] F R Π R - Menu**Access**

[Complete settings] → [Maintenance] → [Fan management]

[Fan Mode] F F Π

Fan force mode.

Setting ()	Code / Value	Description
[Standard]	<i>S t d</i>	Standard Factory setting
[Always]	<i>r u n</i>	Always

[Maintenance] C S P R - Menu**Access****[Complete settings] → [Maintenance]****[Time Counter Reset] r P r**

Time counter reset.

Setting ()	Code / Value	Description
[No]	n o	No Factory setting
[Run Time Reset]	r t H	Clear r t H
[Power ON Time Reset]	P t H	Power on time reset
[RAZ fan on]	F t H	RAZ fan on
[Clear NSM]	n S P	Clear n S P
[Efficiency MAX]	E F Y K	Efficiency max
[Efficiency MIN]	E F Y J	Efficiency min
[Flow Rate MAX]	F S I K	Flow rate max
[Flow Rate MIN]	F S I J	Flow rate min
[Flow Rate MAX]	F S I C	Flow rate max
[Reset all]	R L L	Clear ALL: r t H, r t H i, P t H, F t H, P t H i, G t H i, L t H i

Chapter 7

[Communication] C o N -

Introduction



[Communication] C o N - menu presents the fieldbus submenus.

What Is in This Chapter?

This chapter contains the following topics:

Topic	Page
[Modbus Fieldbus] M d I - Menu	264
[Com. scanner input] , C S - Menu	265
[Com. scanner output] o C S - Menu	266
[Profibus] P b C - Menu	267

[Modbus Fieldbus] *Π d l* - Menu

Access

[Communication] → [Modbus Fieldbus]

About This Menu

This menu is related to the Modbus serial communication port on the back of the control block.

[Modbus Address] *R d d*

Drive Modbus address.

Setting	Description
[OFF] <i>0 F F</i> ...247	Setting range Factory setting: [OFF] <i>0 F F</i>

[Bd.RateModbus] *ε b r*

Baud rate Modbus.

Setting	Code / Value	Description
[19200 bps]	<i>1 9 2</i>	19200 Bauds Factory settings
[38.4 Kbps]	<i>3 8 4</i>	38400 Bauds

[Modbus Format] *ε F 0*

Modbus communication format.

Setting	Code / Value	Description
[8-O-1]	<i>8 0 1</i>	8bits odd parity 1stop bit
[8-E-1]	<i>8 E 1</i>	8bits even parity 1stop bit Factory setting
[8-N-1]	<i>8 n 1</i>	8bits no parity 1stop bit
[8-N-2]	<i>8 n 2</i>	8bits no parity 2stop bits

[Modbus Timeout] *ε ε 0*

Modbus timeout.

Setting	Description
0.1 ...30.0 s	Setting range Factory setting: 10.s

[Com. scanner input] , L 5 - Menu

Access

[Communication] → [Com. scanner input]

[Scan. IN1 address] n P A 1

Address of the first input word.

Setting	Description
0...65535	Setting range Factory setting: 3201 (E L A)

[Scan. IN2 address] n P A 2

Address of the second input word.

Setting	Description
0...65535	Setting range Factory setting: 8604 (r F r d)

[Scan. IN3 address] n P A 3

Address of the third input word.

Setting	Description
0...65535	Setting range Factory setting: 0

[Scan. IN4 address] n P A 4

Address of the fourth input word.

Identical to [Scan. IN3 address] n P A 3.

[Scan. IN5 address] n P A 5

Address of the fifth input word.

Identical to [Scan. IN3 address] n P A 3.

[Scan. IN6 address] n P A 6

Address of the sixth input word.

Identical to [Scan. IN3 address] n P A 3.

[Scan. IN7 address] n P A 7

Address of the seventh input word.

Identical to [Scan. IN3 address] n P A 3.

[Scan. IN8 address] n P A 8

Address of the eighth input word.

Identical to [Scan. IN3 address] n P A 3.

[Com. scanner output] ▢ [5 - Menu

Access

[Communication] → [Com. scanner output]

[Scan.Out1 address] ▢ [A 1

Com scanner output 1 value.
Value of the first output word.

Setting	Description
0...65535	Setting range Factory setting: 8501(<i>L Π d</i>)

[Scan.Out2 address] ▢ [A 2

Address of the eighth output word.

Setting	Description
0...65535	Setting range Factory setting: 8602(<i>L F r d</i>)

[Scan.Out3 address] ▢ [A 3

Com scanner output 3 value.
Value of the third output word.

Setting	Description
0...65535	Setting range Factory setting: 0

[Scan.Out4 address] ▢ [A 4

Address of the fourth output word.
Identical to **[Scan.Out3 address] ▢ [A 3**.

[Scan.Out5 address] ▢ [A 5

Address of the fifth output word.
Identical to **[Scan.Out3 address] ▢ [A 3**.

[Scan.Out6 address] ▢ [A 6

Address of the sixth output word.
Identical to **[Scan.Out3 address] ▢ [A 3**.

[Scan.Out7 address] ▢ [A 7

Address of the seventh output word.
Identical to **[Scan.Out3 address] ▢ [A 3**.

[Scan.Out8 address] ▢ [A 8

Address of the eighth output word.
Identical to **[Scan.Out3 address] ▢ [A 3**.

[Profibus] P b C - Menu

Access

[Communication] → [Profibus]

About This Menu

Refer to the PROFIBUS DP option module manual.

Chapter 8

[File management] F П E -

Introduction



[File management] F П E - menu presents the management of drive configuration files.

What Is in This Chapter?

This chapter contains the following topics:

Topic	Page
[Transfer config file] E C F - Menu	270
[Factory settings] F C S - Menu	271
[Parameter group list] F P Y - Menu	272
[Factory settings] F C S - Menu	273

[Transfer config file] *⌘ C F* - Menu

Access

[File management] → [Transfer config file]

[OPEN] *⌘ P F*

This allows to select a previously saved drive configuration from the Plain Text Display Terminal memory and transfer it to the drive.

[SAVE AS] *⌘ S F F*

This allows to save the actual drive configuration into the Plain Text Display Terminal memory.

[Factory settings] F L 5 - Menu

Access

[File management] → [Factory settings]

About This Menu

This parameter allows to select the configuration to restore in case of factory setting operation.

[Config. Source] F L 5 , ★

Setting	Code / Value	Description
[Macro-Conf]	1 0 1	Software default
[Config 1]	C F G 1	Customer parameter set 1
[Config 2]	C F G 2	Customer parameter set 2
[Config 3]	C F G 3	Customer parameter set 3

[Parameter group list] *F r Y* - Menu

Access

[File management] → [Factory settings] → [Parameter group list]

About This Menu

Selection of menus to be loaded.

NOTE: In factory configuration and after a return to "factory settings", [Parameter group list] *F r Y* will be empty.

[All] *ALL*

All parameters in all menus.

[Drive Configuration] *d r Π*

Load [Complete settings] *CSL* - menu.

[Motor Param] *Π o t*

Load [Motor parameters] *Π P R* - menu.

[Comm. Menu] *CSΠ* ★

Load [Communication] *CSΠ* - menu.

This parameter can be accessed if [Config. Source] *FLS* is set to [Macro-Conf] *in*.

[Display Config.] *d , 5* ★

Load [Display screen type] *Π S C* - menu.

This parameter can be accessed if [Config. Source] *FLS* is set to [Macro-Conf] *in*.

[Factory settings] F C 5 - Menu**Access****[File management] → [Factory settings]****[Go to Factory settings] G F 5**** WARNING****UNANTICIPATED EQUIPMENT OPERATION**

Verify that restoring the factory settings is compatible with the type of wiring used.

Failure to follow these instructions can result in death, serious injury, or equipment damage.

It is only possible to revert to the factory settings if at least one group of parameters has previously been selected.

[Save Configuration] S C 5 , ★

Save configuration.

The active configuration to be saved does not appear for selection. For example, if it is **[Config 0] S E r 0**, only **[Save Config 1] S E r 1** and **[Config 2] S E r 2** appear. The parameter changes back to **[No] n o** as soon as the operation is complete.

Setting	Code / Value	Description
[No]	<i>n o</i>	No Factory setting
[Config 0]	<i>S E r 0</i>	Store customer parameter set 0
[Save Config 1]	<i>S E r 1</i>	Store customer parameter set 1
[Config 2]	<i>S E r 2</i>	Store customer parameter set 2
[Config 3]	<i>S E r 3</i>	Store customer parameter set 3

Chapter 9

[My preferences] ПУР -

Introduction



[My preferences] ПУР - menu presents the possible settings for the user-defined HMI and parameter access.

What Is in This Chapter?

This chapter contains the following sections:

Section	Topic	Page
9.1	[Language]	276
9.2	[Password]	277
9.3	[Customization]	278
9.4	[Access level]	283
9.5	[LCD settings]	284

Section 9.1

[Language]

[Language] L n G - Menu

Access

[My preferences] → [Language]

About This Menu

This menu allows to select the Plain Text Display Terminal language.

Section 9.2

[Password]

[Password] *LoD* - Menu

Access

[My preferences] → [Password]

About This Menu

Enables the configuration to be protected with an access code or a password to be entered in order to access a protected configuration:

- The drive is unlocked when the password is set to **[No password defined]** *no* or when the correct password has been entered. All menus can be accessed.
- Before protecting the configuration with a password, you must:
 - Define the **[Upload rights]** *ULr* and **[Download rights]** *dLr*.
 - Make a careful note of the password and keep it in a place where you will be able to find it.

[Password status] *PSS*

Password status.

Setting	Code / Value	Description
[No password defined]	<i>no</i>	No password defined Factory setting
[Password is unlocked]	<i>uL</i>	Password is unlocked
[Password is locked]	<i>L o C</i>	Password is locked

[Password] *PWd*

6 digits password. The password must be entered in order to unlock the drive. Once the correct code has been entered, the drive is unlocked until the next time the supply mains is disconnected.

[Upload rights] *ULr*

Upload rights.

Setting 	Code / Value	Description
[Permitted]	<i>ULr 0</i>	Commissioning tools or the Plain Text Display Terminal can save the whole configuration (password, monitoring, configuration) Factory setting
[Not allowed]	<i>ULr 1</i>	Commissioning tools or the Plain Text Display Terminal cannot save the configuration

[Download rights] *dLr*

Download rights.

Setting 	Code / Value	Description
[Locked drv]	<i>dLr 0</i>	Lock drive: the configuration can be downloaded only in a locked drive which configuration has the same password
[Unlock. drv]	<i>dLr 1</i>	Unlock drive: the configuration can be downloaded only in a drive without active password Factory setting
[Not allowed]	<i>dLr 2</i>	The configuration can never be downloaded
[Lock/unlock]	<i>dLr 3</i>	Download is permitted according to case 0 or case 1

Section 9.3 [Customization]

What Is in This Section?

This section contains the following topics:

Topic	Page
[My menu config.] ПУС - Menu	279
[Display screen type] ПСЛ - Menu	280
[Param. Bar Select] ПБС - Menu	281
[Customer parameters] СУР - Menu	282

[My menu config.] ПУС - Menu

Access

[My preferences] → [Customization] → [My menu config.]

About This Menu

This menu allows to customize the [My Menu] ПУПН - menu (*see page 40*).

[Parameter Select] ППР

Content of the [Complete settings] ССЛ - menu.

No selections can be made in this screen if there are no parameters.

[Selected List] ППЛ

This menu allows to sort the selected parameters.

[My Menu] ПУПН

Used to define the name of the customized menu.

[Display screen type] П5С - Menu**Access**

[My preferences] → [Customization] → [Display screen type]

About This Menu

This parameter allows to select the type of display for the default screen.

[Display value type] ПДТ

Type of screen display.

Setting 	Code / Value	Description
[Digital]	<i>Д Е С</i>	Digital values Factory setting
[Bar graph]	<i>Б Р Г</i>	Bar graph
[List]	<i>Л И С Т</i>	List of values
[Vu Meter]	<i>В У М Е Т</i>	Vu meter

[PARAMETER SELECTION] ПРС

Customized selection.

This view allows to select the parameters to display on the default screen.

[Param. Bar Select] P b S - Menu

Access

[My preferences] → [Customization] → [Param. Bar Select]

About This Menu

This view allows to select the parameters to display on the top line of the Plain Text Display Terminal screen.

[Customer parameters] C Y P - Menu

Access

[My preferences] → [Customization] → [Customer parameters]

About This Menu

This menu allows to rename up to 15 parameters.

[Parameter Select] S C P

Parameter selection.

This view allows to select up to 15 parameters.

[Customized Selec] C P Π

Customized selection.

This view allows to set the new name for each selected parameter.

Section 9.4

[Access level]

[Access level] L A C - Menu

Access

[My preferences] → [Access level]

About This Menu

WARNING

UNINTENDED EQUIPMENT OPERATION

A single input can activate several functions at the same time (reverse and 2nd ramp for example).
Verify that activating a digital input to several functions does not result in unsafe conditions.

Failure to follow these instructions can result in death, serious injury, or equipment damage.

[Access Level] L A C

Level of access control.

Setting ()	Code / Value	Description
[Basic]	b A S	Access to the [Simply start] S Y S - , [Dashboard] d S H - , [Diagnostics] d , A - and [My preferences] M Y P - menus only. Factory setting
[Expert]	E P r	Access to all menus and to additional parameters.

Section 9.5

[LCD settings]

[LCD settings] **F** **n** **L** - Menu

Access

[My preferences] → [LCD settings]

About This Menu

This menu allows to set the Plain Text Display Terminal related parameters.

[Screen Contrast] **F** **5** **L**

Screen contrast setting.

Setting	Description
0...100%	Setting range Factory setting: 50%

Part III

Maintenance and diagnostics

What Is in This Part?

This part contains the following chapters:

Chapter	Chapter Name	Page
10	Maintenance	287
11	Diagnostics and Troubleshooting	289

Chapter 10

Maintenance

Maintenance

Limitation of Warranty

The warranty does not apply if the product has been opened, except by Schneider Electric services.

Servicing

 DANGER
<p>HAZARD OF ELECTRIC SHOCK, EXPLOSION OR ARC FLASH</p> <p>Read and understand the instructions in Safety Information chapter before performing any procedure in this chapter.</p> <p>Failure to follow these instructions will result in death or serious injury.</p>

NOTICE
<p>RISK OF DAMAGE TO DRIVE</p> <p>Perform the following activities.</p> <p>Failure to follow these instructions can result in equipment damage.</p>

Environment	Part concerned	Action	Periodicity
Knock on the product	Housing - control block (led - display)	Verify the drive visual aspect	At least each year
Corrosion	Terminals - connector - screws - EMC plate	Inspect and clean if required	
Dust	Terminals - fans blowholes		
Temperature	Around the product	Verify and correct if required	
Cooling	Fan	Verify the fan operation	After 3 to 5 years, depending on the operating conditions
		Replace the fan	
Vibration	Terminal connections	Verify tightening at recommended torque	At least each year

Spares and Repairs

Serviceable product. Please contact your Schneider Electric representative.

Long Time Storage

CAUTION

RISK OF DERATED PERFORMANCE DUE TO CAPACITOR AGING

The product capacitor performances after a long time storage above 2 years can be degraded. In that case, before using the product, apply the following procedure:

- Use a variable AC supply connected between L1 and L2 (even for ATV.....N4 catalog numbers)
- Increase AC supply voltage to have:
 - 80% of rated voltage during 30 min
 - 100% of rated voltage for another 30 min

Failure to follow these instructions can result in injury or equipment damage.

Fan Replacement

It is possible to order a new fan for the drive maintenance, see the catalog numbers on www.schneider-electric.com.

Chapter 11

Diagnostics and Troubleshooting

Overview

This chapter describes the various types of diagnostics and provides troubleshooting assistance.

DANGER

HAZARD OF ELECTRIC SHOCK, EXPLOSION OR ARC FLASH

Read and understand the instructions in **Safety Information** chapter before performing any procedure in this chapter.

Failure to follow these instructions will result in death or serious injury.

What Is in This Chapter?

This chapter contains the following sections:

Section	Topic	Page
11.1	Warning Codes	290
11.2	Error Codes	292
11.3	FAQ	370

Section 11.1

Warning Codes

Warning Codes

List of Available Warnings

Setting	Code / Value	Description
[AI1 4-20 Loss Warning]	<i>RP 1</i>	4-20 loss warning on analog input AI1
[AI2 4-20 Loss Warning]	<i>RP 2</i>	4-20 loss warning on analog input AI2
[AI3 4-20 Loss Warning]	<i>RP 3</i>	4-20 loss warning on analog input AI3
[AI4 4-20 Loss Warning]	<i>RP 4</i>	4-20 loss warning on analog input AI4
[AI5 4-20 Loss Warning]	<i>RP 5</i>	4-20 loss warning on analog input AI5
[Cust Warning 1]	<i>C R S 1</i>	Customer warning 1
[Cust Warning 2]	<i>C R S 2</i>	Customer warning 2
[Cust Warning 3]	<i>C R S 3</i>	Customer warning 3
[Cust Warning 4]	<i>C R S 4</i>	Customer warning 4
[Cust Warning 5]	<i>C R S 5</i>	Customer warning 5
[Current Threshold Reached]	<i>C L R</i>	Motor current high threshold reached
[Low Current Reached]	<i>C L R L</i>	Motor current low threshold reached
[Dry Run Warning]	<i>d r R Y</i>	Dry run monitoring function warning
[Ext. Error Warning]	<i>E F R</i>	External error warning
[2nd Frequency Thd Reached]	<i>F 2 R</i>	Second frequency threshold reached
[Motor Freq Low Thd 2]	<i>F 2 R L</i>	Motor frequency low threshold 2 reached
[Fan Counter Warning]	<i>F C L R</i>	Fan counter warning
[Fan Feedback Warning]	<i>F F d R</i>	Fan feedback warning
[High Speed Reached]	<i>F L R</i>	High speed reached
[Motor Freq High Thd 2]	<i>F 9 L R</i>	Motor frequency high threshold 2 reached
[Fallback Frequency]	<i>F r F</i>	Fallback frequency reaction
[Flow Limit Activated]	<i>F S R</i>	Flow limitation monitoring function is active
[Motor Freq High Thd]	<i>F L R</i>	Motor frequency high threshold reached
[Motor Freq Low Thd]	<i>F L R L</i>	Motor frequency low threshold reached
[High Flow Warning]	<i>H F P R</i>	High flow monitoring function warning
[InPress Warning]	<i>i P P R</i>	Inlet pressure monitoring function warning level reached
[Anti-Jam Warning]	<i>J R P R</i>	Anti-Jam maximum cycle counter reached
[Life Cycle Warning 1]	<i>L C R 1</i>	Life cycle warning 1
[Life Cycle Warning 2]	<i>L C R 2</i>	Life cycle warning 2
[Low Flow Warning]	<i>L F R</i>	Low flow monitoring function warning level reached
[LowPres Warning]	<i>L P R</i>	Low pressure monitoring function warning level reached
[No Warning stored]	<i>n o R</i>	No warning stored
[Process Overload Warning]	<i>o L R</i>	Process overload warning
[High OutPres Warning]	<i>o P H R</i>	High outlet pressure warning
[Low OutPres Warning]	<i>o P L R</i>	Low outlet pressure warning
[Switch OutPres Warning]	<i>o P S R</i>	High outlet pressure switch warning
[PumpCycle warning]	<i>P C P R</i>	Pumpcycle warning
[PID Error Warning]	<i>P E E</i>	PID error warning
[PID Feedback Warning]	<i>P F R</i>	PID feedback warning
[PID High Feedback Warning]	<i>P F R H</i>	PID feedback high threshold warning
[PID Low Feedback Warning]	<i>P F R L</i>	PID feedback low threshold warning

Setting	Code / Value	Description
[Regulation Warning]	<i>P r S H</i>	PID feedback regulation warning
[Pump Low Flow]	<i>P L F R</i>	Pump low flow warning level reached
[Power Consumption Warning]	<i>P o W d</i>	Power consumption warning
[Power High Threshold]	<i>P t H R</i>	Power high threshold reached
[Power Low Threshold]	<i>P t H L</i>	Power low threshold reached
[Speed Maintained]	<i>r L S</i>	Speed maintained function is active
[Ref Freq High Thd reached]	<i>r t R H</i>	Reference frequency high threshold reached
[Ref Freq Low Thd reached]	<i>r t R L</i>	Reference frequency low threshold reached
[Ref Frequency Warning]	<i>S r R</i>	Reference frequency reached
[Type of stop]	<i>S t t</i>	Detected error without stop according to [Type of stop] <i>S t t</i>
[Drive Thermal Thd Reached]	<i>t R d</i>	Drive thermal threshold reached
[Drive Thermal Warning]	<i>t H R</i>	Drive thermal state warning
[IGBT Thermal Warning]	<i>t J R</i>	IGBT thermal state warning
[AI2 Th Warning]	<i>t P 2 R</i>	Thermal sensor warning on analog input AI2
[AI3 Th Warning]	<i>t P 3 R</i>	Thermal sensor warning on analog input AI3
[AI4 Th Warning]	<i>t P 4 R</i>	Thermal sensor warning on analog input AI4
[AI5 Th Warning]	<i>t P 5 R</i>	Thermal sensor warning on analog input AI5
[Motor Therm Thd Reached]	<i>t S R</i>	Motor thermal threshold reached
[Process Underload Warning]	<i>u L R</i>	Process underload warning
[Preventive Undervolt Active]	<i>u P R</i>	Preventive undervoltage active
[Undervoltage Warning]	<i>u S R</i>	Undervoltage warning

Section 11.2

Error Codes

What Is in This Section?

This section contains the following topics:

Topic	Page
Overview	294
[Angle error] <i>R 5 F</i>	295
[Incorrect Configuration] <i>C F F</i>	296
[Invalid Configuration] <i>C F i</i>	297
[Conf Transfer Error] <i>C F i 2</i>	298
[Fieldbus Com Interrupt] <i>C n F</i>	299
[Precharge Capacitor] <i>C r F</i>	300
[Channel Switch Error] <i>C S F</i>	301
[EEPROM Control] <i>E E F 1</i>	302
[EEPROM Power] <i>E E F 2</i>	303
[External Error] <i>E P F 1</i>	304
[Fieldbus Error] <i>E P F 2</i>	305
[Boards Compatibility] <i>H C F</i>	306
[Internal Link Error] <i>i L F</i>	307
[Internal Error 0] <i>i n F 0</i>	308
[Internal Error 1] <i>i n F 1</i>	309
[Internal Error 2] <i>i n F 2</i>	310
[Internal Error 3] <i>i n F 3</i>	311
[Internal Error 4] <i>i n F 4</i>	312
[Internal Error 6] <i>i n F 6</i>	313
[Internal Error 7] <i>i n F 7</i>	314
[Internal Error 8] <i>i n F 8</i>	315
[Internal Error 9] <i>i n F 9</i>	316
[Internal Error 10] <i>i n F A</i>	317
[Internal Error 11] <i>i n F b</i>	318
[Internal Error 12] <i>i n F C</i>	319
[Internal Error 13] <i>i n F d</i>	320
[Internal Error 14] <i>i n F E</i>	321
[Internal Error 15] <i>i n F F</i>	322
[Internal Error 16] <i>i n F G</i>	323
[Internal Error 17] <i>i n F h</i>	324
[Internal Error 18] <i>i n F i</i>	325
[Internal Error 20] <i>i n F K</i>	326
[Internal Error 21] <i>i n F L</i>	327
[Internal Error 22] <i>i n F M</i>	328
[Internal Error 25] <i>i n F P</i>	329
[Internal Error 27] <i>i n F r</i>	330
[Input Contactor] <i>L C F</i>	331
[AI1 4-20mA loss] <i>L F F 1</i>	332
[AI2 4-20mA loss] <i>L F F 2</i>	333
[AI3 4-20mA loss] <i>L F F 3</i>	334
[AI4 4-20mA loss] <i>L F F 4</i>	335
[AI5 4-20mA loss] <i>L F F 5</i>	336

Topic	Page
[DC Bus Overvoltage] <i>o b F</i>	337
[Overcurrent] <i>o C F</i>	338
[Drive Overheating] <i>o H F</i>	339
[Process Overload] <i>o L C</i>	340
[Motor Overload] <i>o L F</i>	341
[Single Output Phase Loss] <i>o P F 1</i>	342
[Output Phase Loss] <i>o P F 2</i>	343
[Supply Mains Overvoltage] <i>o S F</i>	344
[PID Feedback Error] <i>P F Π F</i>	345
[Program Loading Error] <i>P G L F</i>	346
[Program Running Error] <i>P G r F</i>	347
[Input phase loss] <i>P H F</i>	348
[Motor short circuit] <i>S C F 1</i>	349
[Ground Short Circuit] <i>S C F 3</i>	350
[IGBT Short Circuit] <i>S C F 4</i>	351
[Motor Short Circuit] <i>S C F 5</i>	352
[Modbus Com Interruption] <i>S L F 1</i>	353
[PC Com Interruption] <i>S L F 2</i>	354
[HMI Com Interruption] <i>S L F 3</i>	355
[Motor Overspeed] <i>S o F</i>	356
[Motor Stall Error] <i>S t F</i>	357
[AI2 Thermal Sensor Error] <i>t 2 C F</i>	358
[AI3 Thermal Sensor Error] <i>t 3 C F</i>	359
[AI4 Thermal Sensor Error] <i>t 4 C F</i>	360
[AI5 Thermal Sensor Error] <i>t 5 C F</i>	361
[AI2 Th Error Level] <i>t H 2 F</i>	362
[AI3 Th Error Level] <i>t H 3 F</i>	363
[AI4 Th Error Level] <i>t H 4 F</i>	364
[AI5 Th Error Level] <i>t H 5 F</i>	365
[IGBT Overheating] <i>t J F</i>	366
[Autotuning Error] <i>t n F</i>	367
[Process Underload] <i>u L F</i>	368
[Supply Mains Undervoltage] <i>u S F</i>	369

Overview

Clearing the Detected Error

This table presents the steps to follow if intervention on the drive system is required:

Step	Action
1	Disconnect all power, including external control power that may be present.
2	Lock that all power disconnects in the open position.
3	Wait 15 minutes to allow the DC bus capacitors to discharge (the drive LEDs are not indicators of the absence of DC bus voltage).
4	Measure the voltage of the DC bus between the PA/+ and PC/- terminals to ensure that the voltage is less than 42 Vdc.
5	If the DC bus capacitors do not discharge completely, contact your local Schneider Electric representative. Do not repair or operate the drive.
6	Find and correct the cause of the detected error.
7	Restore power to the drive to confirm that the detected error has been rectified.

After the cause has been removed, the detected error can be cleared by:

- Switching off the drive.
- Using the **[Product Restart]** $r P$ parameter.
- Using the **[Auto Fault Reset]** $f E r$ - function.
- A digital input or control bit set to the **[Fault reset]** $r 5 E$ - function.
- Pressing the STOP/RESET key on the Plain Text Display Terminal if the active command channel is set to **[Ref. Freq-Rmt.Term]** $L C C$.

[Angle error] A5F**Probable Cause**

For the motor control type **[Sync. mot.] S Y n u**, wrong setting of the speed loop when the reference goes through 0.

**Remedy**

- Verify the speed loop parameters.
- Verify the motor phases and the maximum current allowed by the drive.

**Clearing the Error Code**

This detected error requires a power reset.

[Incorrect Configuration] *L F F*



Probable Cause

- Option module changed or removed.
- Control block replaced by a control block configured on a drive with a different rating.
- The current configuration is inconsistent.



Remedy

- Verify that there is no detected error on the option module.
- In the event of the control block being changed deliberately, see the remarks below.
- Return to factory settings or retrieve the backup configuration if it is valid.



Clearing the Error Code

This detected error is cleared as soon as its cause disappears.

[Invalid Configuration] [F]**Probable Cause**

Invalid configuration. The configuration loaded in the drive via the commissioning tool or fieldbus is inconsistent.

**Remedy**

- Verify the previously loaded configuration.
- Load a compatible configuration.

**Clearing the Error Code**

This detected error is cleared as soon as its cause disappears.

[Conf Transfer Error] [F] [2]



Probable Cause

The configuration has not been transferred properly.



Remedy

- Check the configuration loaded previously.
- Load a compatible configuration.



Clearing the Error Code

This detected error is cleared as soon as its cause disappears.

[Fieldbus Com Interrupt] $E n F$ **Probable Cause**

Communication interruption on fieldbus module.

**Remedy**

- Verify the environment (electromagnetic compatibility).
- Verify the wiring.
- Verify the timeout.
- Replace the option module.
- Contact your local Schneider Electric representative

**Clearing the Error Code**

This detected error can be cleared with the **[Auto Fault Reset] $H E r$** or manually with the **[Fault Reset Assign] $r 5 F$** parameter after the cause has disappeared.

[Precharge Capacitor] $C r F$



Probable Cause

Charging circuit control detected error or charging resistor damaged.



Remedy

- Turn off the drive and then turn on again.
- Verify the internal connections.
- Contact your local Schneider Electric representative



Clearing the Error Code

This detected error requires a power reset.

[Channel Switch Error] C 5 F**Probable Cause**

Switch to a not valid channels.

**Remedy**

Verify the function parameters.

**Clearing the Error Code**

This detected error is cleared as soon as its cause disappears.

[EEPROM Control] E E F I



Probable Cause

An error of the internal memory of the control block has been detected.



Remedy

- Verify the environment (electromagnetic compatibility).
- Switch off the product.
- Return to factory settings.
- Contact your local Schneider Electric representative.



Clearing the Error Code

This detected error requires a power reset.

[EEPROM Power] E E F 2**Probable Cause**

An error of the internal memory of the power board has been detected.

**Remedy**

- Verify the environment (electromagnetic compatibility).
- Switch off the product.
- Return to factory settings.
- Contact your local Schneider Electric representative.

**Clearing the Error Code**

This detected error requires a power reset.

[External Error] *E P F 1*



Probable Cause

Event triggered by an external device, depending on user.



Remedy

Remove the cause of the external error.



Clearing the Error Code

This detected error can be cleared with the **[Auto Fault Reset] *R E r*** or manually with the **[Fault Reset Assign] *r 5 F*** parameter after the cause has disappeared.

[Fieldbus Error] *E P F 2***Probable Cause**

An external error has been triggered via fieldbus.

**Remedy**

Remove the cause of the external error.

**Clearing the Error Code**

This detected error can be cleared with the **[Auto Fault Reset] *A E r*** or manually with the **[Fault Reset Assign] *r 5 F*** parameter after the cause has disappeared.

[Boards Compatibility] HCF



Probable Cause

The **[Pairing password] PP** , parameter has been enabled and an option module has been changed.



Remedy

- Refit the original option module.
- Confirm the configuration by entering the **[Pairing password] PP** , if the module was changed deliberately.



Clearing the Error Code

This detected error is cleared as soon as its cause disappears.

[Internal Link Error] , L F**Probable Cause**

Communication interruption between option module and the drive.

**Remedy**

- Verify the environment (electromagnetic compatibility).
- Verify the connections.
- Replace the option module.
- Contact your local Schneider Electric representative.

**Clearing the Error Code**

This detected error requires a power reset.

[Internal Error 0] INF0



Probable Cause

Communication interruption between microprocessors of the control board.



Remedy

Contact your local Schneider Electric representative.



Clearing the Error Code

This detected error requires a power reset.

[Internal Error 1] INF 1**Probable Cause**

The power board rating is not valid.

**Remedy**

Contact your local Schneider Electric representative.

**Clearing the Error Code**

This detected error requires a power reset.

[Internal Error 2] INF2



Probable Cause

The power board is incompatible with the control block software.



Remedy

Contact your local Schneider Electric representative.



Clearing the Error Code

This detected error requires a power reset.

[Internal Error 3] INF3**Probable Cause**

Internal communication detected error.

**Remedy**

- Verify the wiring on drive control terminals (internal 10V supply for analog inputs overloaded).
- Contact your local Schneider Electric representative.

**Clearing the Error Code**

This detected error requires a power reset.

[Internal Error 4] INF4



Probable Cause

Internal data inconsistent.



Remedy

Contact your local Schneider Electric representative.



Clearing the Error Code

This detected error requires a power reset.

[Internal Error 6] INF6**Probable Cause**

The option module installed in the drive is not recognized.

**Remedy**

Verify the catalog number and compatibility of the option module.

**Clearing the Error Code**

This detected error requires a power reset.

[Internal Error 7] INF 7



Probable Cause

Communication interruption with CPLD component of Control board.



Remedy

Contact your local Schneider Electric representative.



Clearing the Error Code

This detected error requires a power reset.

[Internal Error 8] INF B**Probable Cause**

The internal power switching supply is not correct.

**Remedy**

Contact your local Schneider Electric representative.

**Clearing the Error Code**

This detected error requires a power reset.

[Internal Error 9] *INF9*



Probable Cause

An error on the current circuit measurement has been detected.



Remedy

Contact your local Schneider Electric representative.



Clearing the Error Code

This detected error can be cleared with the **[Auto Fault Reset] *AR*** or manually with the **[Fault Reset Assign] *r5F*** parameter after the cause has disappeared.

[Internal Error 10] INF R**Probable Cause**

The input stage is not operating correctly.

**Remedy**

Contact your local Schneider Electric representative.

**Clearing the Error Code**

This detected error requires a power reset.

[Internal Error 11] *inFb*



Probable Cause

The internal drive thermal sensor is not operating correctly.



Remedy

Contact your local Schneider Electric representative.



Clearing the Error Code

This detected error can be cleared with the **[Auto Fault Reset] *AR*** or manually with the **[Fault Reset Assign] *r5F*** parameter after the cause has disappeared.

[Internal Error 12] *INF***Probable Cause**

Internal current supply error.

**Remedy**

Contact your local Schneider Electric representative.

**Clearing the Error Code**

This detected error requires a power reset.

[Internal Error 13] *INF d*



Probable Cause

Differential current deviation.



Remedy

Contact your local Schneider Electric representative.



Clearing the Error Code

This detected error requires a power reset.

[Internal Error 14] INF E**Probable Cause**

Internal microprocessor detected error.

**Remedy**

- Verify that the error code can be cleared.
- Contact your local Schneider Electric representative.

**Clearing the Error Code**

This detected error requires a power reset.

[Internal Error 15] *INF*



Probable Cause

Serial memory flash format error.



Remedy

Contact your local Schneider Electric representative.



Clearing the Error Code

This detected error requires a power reset.

[Internal Error 16] INF6**Probable Cause**

Communication interruption with the Extension module of output relays module or internal error of the Extension module of output relays

**Remedy**

- Replace the option module.
- Contact your local Schneider Electric representative.

**Clearing the Error Code**

This detected error requires a power reset.

[Internal Error 17] *INFh*



Probable Cause

Communication interruption with the Extension module of digital & analog I/O or internal error of the Extension module of digital & analog I/O.



Remedy

- Replace the option module.
- Contact your local Schneider Electric representative.



Clearing the Error Code

This detected error requires a power reset.

[Internal Error 18] INF 1**Probable Cause**

Communication interruption with Safety function module or internal error of the Safety function module.

**Remedy**

- Replace the option module.
- Contact your local Schneider Electric representative.

**Clearing the Error Code**

This detected error requires a power reset.

[Internal Error 20] *INFK*



Probable Cause

Option module interface board error.



Remedy

Contact your local Schneider Electric representative.



Clearing the Error Code

This detected error requires a power reset.

[Internal Error 21] *inFL***Probable Cause**

Internal Real Time Clock error.

**Remedy**

Contact your local Schneider Electric representative.

**Clearing the Error Code**

This detected error requires a power reset.

[Internal Error 22] INF Π



Probable Cause

Ethernet embedded internal error.



Remedy

Contact your local Schneider Electric representative.



Clearing the Error Code

This detected error requires a power reset.

[Internal Error 25] INF P**Probable Cause**

Incompatibility between Control Board hardware version and firmware version.

**Remedy**

- Update the firmware package.
- Contact your local Schneider Electric representative.

**Clearing the Error Code**

This detected error requires a power reset.

[Internal Error 27] *inFr*



Probable Cause

Diagnostics in CPLD have detected an error.



Remedy

Contact your local Schneider Electric representative.



Clearing the Error Code

This detected error requires a power reset.

[Input Contactor] L C F**Probable Cause**

The drive is not switched on even though **[Mains V. time out] L C E** timeout has elapsed.

**Remedy**

- Verify the input contactor and its wiring.
- Verify the **[Mains V. time out] L C E** timeout.
- Verify the supply mains/contactor/drive wiring.

**Clearing the Error Code**

This detected error can be cleared with the **[Auto Fault Reset] A E r** or manually with the **[Fault Reset Assign] r 5 F** parameter after the cause has disappeared.

[AI1 4-20mA loss] L F F I



Probable Cause

Loss of the 4-20 mA on analog input AI1.



Remedy

Verify the connection on the analog inputs.



Clearing the Error Code

This detected error can be cleared with the **[Auto Fault Reset] # L r** or manually with the **[Fault Reset Assign] r 5 F** parameter after the cause has disappeared.

[AI2 4-20mA loss] L F F 2**Probable Cause**

Loss of the 4-20 mA on analog input AI2.

**Remedy**

Verify the connection on the analog inputs.

**Clearing the Error Code**

This detected error can be cleared with the **[Auto Fault Reset] # E r** or manually with the **[Fault Reset Assign] r 5 F** parameter after the cause has disappeared.

[AI3 4-20mA loss] L F F 3



Probable Cause

Loss of the 4-20 mA on analog input AI3.



Remedy

Verify the connection on the analog inputs.



Clearing the Error Code

This detected error can be cleared with the **[Auto Fault Reset] # L r** or manually with the **[Fault Reset Assign] r 5 F** parameter after the cause has disappeared.

[AI4 4-20mA loss] L F F 4**Probable Cause**

Loss of the 4-20 mA on analog input AI4.

**Remedy**

Verify the connection on the analog inputs.

**Clearing the Error Code**

This detected error can be cleared with the **[Auto Fault Reset] # E r** or manually with the **[Fault Reset Assign] r 5 F** parameter after the cause has disappeared.

[AI5 4-20mA loss] L F F 5



Probable Cause

Loss of the 4-20 mA on analog input AI5.



Remedy

Verify the connection on the analog inputs.



Clearing the Error Code

This detected error can be cleared with the **[Auto Fault Reset] # L r** or manually with the **[Fault Reset Assign] r 5 F** parameter after the cause has disappeared.

[DC Bus Overvoltage] ▫ b F**Probable Cause**

- Deceleration time too short or driving load.
- Supply mains voltage too high.

**Remedy**

- Increase the deceleration time.
- Configure the **[Dec ramp adapt.]** *b r A* function if it is compatible with the application.
- Verify the supply mains voltage.

**Clearing the Error Code**

This detected error can be cleared with the **[Auto Fault Reset]** *A E r* or manually with the **[Fault Reset Assign]** *r 5 F* parameter after the cause has disappeared.

[Drive Overheating] □ HF**Probable Cause**

Drive temperature too high.

**Remedy**

Verify the motor load, the drive ventilation, and the ambient temperature. Wait for the drive to cool down before restarting.

**Clearing the Error Code**

This detected error can be cleared with the **[Auto Fault Reset] F L r** or manually with the **[Fault Reset Assign] r 5 F** parameter after the cause has disappeared.

[Process Overload] *o L C*



Probable Cause

Process overload.



Remedy

- Verify and remove the cause of the overload.
- Verify the parameters of the **[Process overload]** *o L d* - function.



Clearing the Error Code

This detected error can be cleared with the **[Auto Fault Reset]** *A F r* or manually with the **[Fault Reset Assign]** *r 5 F* parameter after the cause has disappeared.

[Motor Overload] $\square L F$ **Probable Cause**

Triggered by excessive motor current.

**Remedy**

Verify the setting of the motor thermal monitoring, verify the motor load. Wait for the motor to cool down before restarting.

**Clearing the Error Code**

This detected error can be cleared with the **[Auto Fault Reset] $\# E r$** or manually with the **[Fault Reset Assign] $r 5 F$** parameter after the cause has disappeared.

[Single Output Phase Loss] \square P F I



Probable Cause

Loss of one phase at drive output.



Remedy

Verify the wiring from the drive to the motor.



Clearing the Error Code

This detected error can be cleared with the **[Auto Fault Reset] R L r** or manually with the **[Fault Reset Assign] r 5 F** parameter after the cause has disappeared.

[Output Phase Loss] $\square P F 2$



Probable Cause

- Motor not connected or motor power too low.
- Output contactor opened.
- Instantaneous instability in the motor current.



Remedy

- Verify the wiring from the drive to the motor.
- If an output contactor is being used, set **[OutPhaseLoss Assign] $\square P L$** to **[No Error Triggered] $\square R C$** .
- If the drive is connected to a low-power motor or not connected to a motor: In factory settings mode, motor phase loss detection is active **[Output Phase Loss] $\square P L = [OPF Error Triggered] 5 E 5$** . Deactivate motor phase loss detection **[Output Phase Loss] $\square P L = [Function Inactive] n a$** .
- Verify and optimize the following parameters: **[IR compensation] $\mu F r$** , **[Nom Motor Voltage] $\mu n 5$** and **[Rated mot. current] $n C r$** and perform **[Autotuning] $E u n$** .



Clearing the Error Code

This detected error can be cleared with the **[Auto Fault Reset] $R E r$** or manually with the **[Fault Reset Assign] $r 5 F$** parameter after the cause has disappeared.

[Supply Mains Overvoltage] $r 5 F$



Probable Cause

- Supply mains voltage too high.
- Disturbed supply mains.



Remedy

Verify the supply mains voltage.



Clearing the Error Code

This detected error can be cleared with the **[Auto Fault Reset] $r 5 r$** or manually with the **[Fault Reset Assign] $r 5 F$** parameter after the cause has disappeared.

[PID Feedback Error] P F Π F**Probable Cause**

The PID feedback error was out of the allowed range around the set point during the time window.

**Remedy**

- Check for mechanical breakdown of pipes.
- Check for water leakage.
- Check for open discharge valve.
- Check for fire hydrant opened.
- Verify the settings of the monitoring function.

**Clearing the Error Code**

This detected error can be cleared with the **[Auto Fault Reset] # E r** or manually with the **[Fault Reset Assign] r 5 F** parameter after the cause has disappeared.

[Program Loading Error] P G L F



Probable Cause

Verify that the error code can be cleared.



Remedy

Contact your local Schneider Electric representative.



Clearing the Error Code

This detected error is cleared as soon as its cause disappears.

[Program Running Error] P G r F**Probable Cause**

Verify that the error code can be cleared.

**Remedy**

Contact your local Schneider Electric representative.

**Clearing the Error Code**

This detected error requires a power reset.

[Input phase loss] PHF



Probable Cause

- Drive incorrectly supplied or a tripped fused.
- One phase missing.
- 3-phase drive used on a single-phase supply mains.
- Unbalanced load.



Remedy

- Check the power connection and the fuses.
- Use a 3-phase supply mains.
- Disable the detected error by **[Input phase loss] rPL = [No]** if single phase supply mains is used.



Clearing the Error Code

This detected error is cleared as soon as its cause disappears.

[Motor short circuit] 5CF1**Probable Cause**

Short-circuit or grounding at the drive output.

**Remedy**

- Verify the cables connecting the drive to the motor, and the motor insulation.
- Reduce the switching frequency.
- Connect chokes in series with the motor.
- Verify the adjustment of speed loop and brake.
- Increase the **[Time to restart] t_{tr}**
- Increase the switching frequency.

**Clearing the Error Code**

This detected error requires a power reset.

[Ground Short Circuit] 5 [F] 3



Probable Cause

Significant ground leakage current at the drive output if several motors are connected in parallel.



Remedy

- Verify the cables connecting the drive to the motor, and the motor insulation.
- Reduce the switching frequency.
- Connect chokes in series with the motor.
- Verify the adjustment of speed loop and brake.
- Increase the **[Time to restart] t_{tr}**
- Increase the switching frequency.



Clearing the Error Code

This detected error requires a power reset.

[IGBT Short Circuit] 5 C F 4**Probable Cause**

Power component detected error.

**Remedy**

Contact your local Schneider Electric representative.

**Clearing the Error Code**

This detected error can be cleared with the **[Auto Fault Reset] # E r** or manually with the **[Fault Reset Assign] r 5 F** parameter after the cause has disappeared.

[Motor Short Circuit] 5 L F 5



Probable Cause

Short-circuit at drive output.



Remedy

- Verify the cables connecting the drive to the motor, and the motor's insulation.
- Contact your local Schneider Electric representative.



Clearing the Error Code

This detected error can be cleared with the **[Auto Fault Reset] R E r** or manually with the **[Fault Reset Assign] r 5 F** parameter after the cause has disappeared.

[Modbus Com Interruption] 5 L F 1**Probable Cause**

Communication interruption on the Modbus port.

**Remedy**

- Verify the communication bus.
- Verify the timeout.
- Refer to the Modbus user manual.

**Clearing the Error Code**

This detected error can be cleared with the **[Auto Fault Reset] *AE r*** or manually with the **[Fault Reset Assign] *r 5 F*** parameter after the cause has disappeared.

[PC Com Interruption] 5 L F 2



Probable Cause

Communication interruption with the commissioning software.



Remedy

- Verify the commissioning software connecting cable.
- Verify the timeout.



Clearing the Error Code

This detected error can be cleared with the **[Auto Fault Reset] R E r** or manually with the **[Fault Reset Assign] r 5 F** parameter after the cause has disappeared.

[HMI Com Interruption] 5 L F 3**Probable Cause**

Communication interruption with the Display Terminal.

**Remedy**

- Verify the Display Terminal connection.
- Verify the timeout.

**Clearing the Error Code**

This detected error can be cleared with the **[Auto Fault Reset] *r* 5 F** or manually with the **[Fault Reset Assign] *r* 5 F** parameter after the cause has disappeared.

[Motor Overspeed] 5 □ F



Probable Cause

Instability or driving load too high.



Remedy

- Verify the motor parameter settings.
- Verify the size of the motor/drive/load.



Clearing the Error Code

This detected error requires a power reset.

[Motor Stall Error] 5 L F**Probable Cause**

The stall monitoring function has detected an error.

**Remedy**

- Search for a mechanical blocking of the motor.
- Search for a possible cause of motor overload.
- Verify the settings of the monitoring function.

**Clearing the Error Code**

This detected error can be cleared with the **[Auto Fault Reset] P L r** or manually with the **[Fault Reset Assign] r 5 F** parameter after the cause has disappeared.

[AI2 Thermal Sensor Error] *E 2 C F*



Probable Cause

The thermal sensor monitoring function has detected a thermal sensor error on analog input AI2:

- Open circuit, or
- Short circuit.



Remedy

- Verify the sensor and its wiring.
- Replace the sensor.



Clearing the Error Code

This detected error can be cleared with the **[Auto Fault Reset] *A E r*** or manually with the **[Fault Reset Assign] *r 5 F*** parameter after the cause has disappeared.

[AI3 Thermal Sensor Error] E 3 C F**Probable Cause**

The thermal sensor monitoring function has detected a thermal sensor error on analog input AI3:

- Open circuit, or
- Short circuit.

**Remedy**

- Verify the sensor and its wiring.
- Replace the sensor.

**Clearing the Error Code**

This detected error can be cleared with the **[Auto Fault Reset] P E r** or manually with the **[Fault Reset Assign] r 5 F** parameter after the cause has disappeared.

[AI4 Thermal Sensor Error] *E 4 C F*



Probable Cause

The thermal sensor monitoring function has detected a thermal sensor error on analog input AI4:

- Open circuit, or
- Short circuit.



Remedy

- Verify the sensor and its wiring.
- Replace the sensor.



Clearing the Error Code

This detected error can be cleared with the **[Auto Fault Reset] *R E r*** or manually with the **[Fault Reset Assign] *r 5 F*** parameter after the cause has disappeared.

[AI5 Thermal Sensor Error] E 5 C F**Probable Cause**

The thermal sensor monitoring function has detected a thermal sensor error on analog input AI5:

- Open circuit, or
- Short circuit.

**Remedy**

- Verify the sensor and its wiring.
- Replace the sensor.

**Clearing the Error Code**

This detected error can be cleared with the **[Auto Fault Reset] R E r** or manually with the **[Fault Reset Assign] r 5 F** parameter after the cause has disappeared.

[AI2 Th Error Level] *E H 2 F*



Probable Cause

The thermal sensor monitoring function has detected a high temperature error on analog input AI2.



Remedy

- Search for a possible cause of overheating.
- Verify the settings of the monitoring function.



Clearing the Error Code

This detected error can be cleared with the **[Auto Fault Reset] *R E r*** or manually with the **[Fault Reset Assign] *r 5 F*** parameter after the cause has disappeared.

[AI3 Th Error Level] L H 3 F **Probable Cause**

The thermal sensor monitoring function has detected a high temperature error on analog input AI3.

**Remedy**

- Search for a possible cause of overheating.
- Verify the settings of the monitoring function.

**Clearing the Error Code**

This detected error can be cleared with the **[Auto Fault Reset] R E r** or manually with the **[Fault Reset Assign] r 5 F** parameter after the cause has disappeared.

[AI4 Th Error Level] *E H 4 F*



Probable Cause

The thermal sensor monitoring function has detected a high temperature error on analog input AI4.



Remedy

- Search for a possible cause of overheating.
- Verify the settings of the monitoring function.



Clearing the Error Code

This detected error can be cleared with the **[Auto Fault Reset] *R E r*** or manually with the **[Fault Reset Assign] *r 5 F*** parameter after the cause has disappeared.

[AI5 Th Error Level] *E H 5 F***Probable Cause**

The thermal sensor monitoring function has detected a high temperature error on analog input AI5.

**Remedy**

- Search for a possible cause of overheating.
- Verify the settings of the monitoring function.

**Clearing the Error Code**

This detected error can be cleared with the **[Auto Fault Reset] *R E r*** or manually with the **[Fault Reset Assign] *r 5 F*** parameter after the cause has disappeared.

[IGBT Overheating] *E J F*



Probable Cause

Drive power stage overheating.



Remedy

- Verify the size of the load/motor/drive according to environment conditions.
- Reduce the switching frequency.



Clearing the Error Code

This detected error can be cleared with the **[Auto Fault Reset] *AE r*** or manually with the **[Fault Reset Assign] *r 5 F*** parameter after the cause has disappeared.

[Autotuning Error] E n F**Probable Cause**

- Special motor or motor whose power is not suitable for the drive.
- Motor not connected to the drive.
- Motor not stopped

**Remedy**

- Verify that the motor/drive are compatible.
- Verify that the motor is connected to the drive during autotuning.
- If an output contactor is being used, verify that it is closed during autotuning.
- Verify that the motor is stopped during autotuning

**Clearing the Error Code**

This detected error requires a power reset.

[Process Underload] $\cup L F$



Probable Cause

Process underload.



Remedy

- Verify and remove the cause of the underload.
- Verify the parameters of the **[PROCESS UNDERLOAD] $\cup L d$** - function



Clearing the Error Code

This detected error can be cleared with the **[Auto Fault Reset] $R E r$** or manually with the **[Fault Reset Assign] $r 5 F$** parameter after the cause has disappeared.

[Supply Mains Undervoltage] \cup 5 F



Probable Cause

- supply mains too low.
- Transient voltage dips.



Remedy

Verify the voltage and the parameters of **[Undervoltage handling]** \cup 5 b.



Clearing the Error Code

This detected error is cleared as soon as its cause disappears.

Section 11.3

FAQ

FAQ

Introduction

If the display does not light up, verify the supply mains to the drive.

The assignment of the fast stop or freewheel functions help to prevent the drive starting if the corresponding digital inputs are not switched on. The drive then displays **[Freewheel] n 5 E** in freewheel stop and **[Fast stop] F 5 E** in fast stop. This is a normal behavior since these functions are active at zero so that the drive is stopped if there is a wire break.

Verify that the run command input is activated in accordance with the selected control mode (**[2/3-wire control] E C C** and **[2-wire type] E C E** parameters).

If the reference channel or command channel is assigned to a fieldbus, when the supply mains is connected, the drive displays **[Freewheel] n 5 E**. It remains in stop mode until the fieldbus gives a command.

Option Module Changed or Removed

When an option module is removed or replaced by another, the drive locks in **[Incorrect configuration] C F F** error mode at power on. If the option module has been deliberately changed or removed, the detected error can be cleared by pressing the **OK** key twice, which causes the factory settings to be restored for the parameter groups affected by the option module.

Control Block Changed

When a control block is replaced by a control block configured on a drive with a different rating, the drive locks in **[Incorrect configuration] C F F** fault mode at power on. If the control block has been deliberately changed, the detected error can be cleared by pressing the **OK** key twice, which **causes all the factory settings to be restored**.

